



DURAGRID™
FACADE SYSTEM



bgcinnovadesign.com.au

BGC's stunning InnovaTM range of facade, lining and flooring products will move you to reassess your concept of excellence in facades and flooring systems. InnovaTM is durable and dynamic, fresh and contemporary. Now let the InnovaTM range of cladding and flooring products breathe new life into your creativity and project specification.

Contents

8 // Applications
8 // Product Information
8 // Fire Resistance
8 // Durability
8 // Sheet sizes and weight
9 // Handling and storage
9 // Accessories
9 // Fasteners
10 // Design Considerations
10 // Control Joints
11 // Panel preparation
11 // Backing Strip Installation and Sealing
12 // Fastener spacing
12 // Batten span/Wind classification
13 // Batten Installation
14-19 // Installation details
20 // Bushfire and Boundary Wall Areas
21 // Deemed to Comply

DURAGRID™ FACADE SYSTEM

BGC's market-leading fibre cement sheeting makes the Duragrid™ facade system a wise choice for cladding exteriors of low to medium-rise homes. Extremely robust and hardwearing, Duragrid™ will give any building an excitingly modern sheen.

With its smooth, flat surface, a square-edge finish simply made for expressed jointing and panels that won't rot, burn or corrode, Duragrid™ enables easy decoration in an exciting variety of design finishes.

Duragrid™ facade system

- / Lightweight, modern and highly durable
- / Perfect for a range of finishes – from painted to textured coatings
- / Unaffected by termites, air, steam, salt or sunlight
- / Quick, simple screw or nail fix installation
- / Available with hardwood timber battens for residential installations

Specify Duragrid™ with confidence

bgcinnovadesign.com.au/fire-resistant





Innova™ deemed to comply external facade systems.

- / Compressed Fibre Cement range
- / Architecturally designed weatherboard range
- / Grooved and profiled cladding range

BGC's products have superior fire performance against four key indicies.



Ignition index = 0

Fibre cement does not ignite



Spread of flame index = 0

There is no spread of fire with fibre cement



Heat evolved index = 0

Heat does not evolve from fibre cement



Smoke developed index = 0-1

Smoke is not emitted from fibre cement



Up to **BAL 40**
as per AS3959:2009



Tested in Australia by accredited Australian authorities **CSIRO** and **Exova Warrington**

Case Study 01.

Project: Freshwater East Kimberley Apartments
Location: Kununurra, WA
Builder: Thoroughbred Constructions

115 apartments comprising studio, 1, 2 and 3 bedrooms
Kununurra's only 4.5 Star Resort.

Products used for feature facades:
Innova™ Duragrid™

Other Innova™ products used:
Innova™ Duragroove™
Innova™ Durafloor™
Innova™ Stratum™
Durasheet™



Case Study 02.

Project: Breezes Muirhead Defence Housing
Location: Darwin, Northern Territory
Builder: Ri-Con Construction

Breezes Muirhead is an award-winning residential development comprising of 1,151 allotments in the highly sought after Darwin suburb of Muirhead. Defence Housing Australia built 329 houses for defence members and their families. Of these, 34 houses and 1 duplex has used a range of BGC Innovatm products as façade systems.

“We wanted a facade system that met all of the cyclonic regulations and was easy to certify. BGC’s range of facade systems met this criteria and also gave us the design flexibility our client was looking for”.

Jaco Botha, Ri-Con’s Construction Manager.



bgcinnovadesign.com.au

Applications

Duragrid™ facade system utilises BGC Fibre Cement panels and primed timber or steel battens to form a strong and durable facade cladding system.

Duragrid™ is ideally suited for versatile architectural applications in domestic and multi storey residential buildings.

Duragrid™ panels are designed for installation in a variety of patterns, including vertical, horizontal or brick-bond.

Duragrid™ panels are available in 9mm thickness and may be finished with site applied acrylic paint systems or a factory applied high quality polyurethane paint finish. These may need alternative fixing methods. Please contact your BGC office for advice.

NOTE: The fitting of the Duragrid™ facade system should only be attempted by a professional contractor. Your local Fibre Cement office can provide you with a list of recommended Duragrid™ installers.

Advantages

- / Lightweight cladding system
- / Readily accepts many forms of decorative finish
- / Highly durable
- / Dynamic architectural style
- / Face sealed panels

Energy Efficiency Considerations

Energy efficiency requirements have been introduced into the Building Code of Australia (BCA) for both commercial and residential buildings. Thermal heat transfer into and out of the building envelope will effect the running cost of the building and careful consideration of thermal heat transfer needs to be addressed by the architects, engineers and building designers.

Product Information

Duragrid™ panels are an autoclaved, cellulose fibre reinforced silica/cement panel, specially formulated and prepared to meet the requirements for use in exterior applications. Duragrid™ panels have a smooth flat surface and a neat square edged finish, for enhanced expressed joint facades.

BGC Fibre Cement products are manufactured to the Australian / New Zealand Standard AS/NZS 2908.2-2000 Cellulose-Cement Products, Part 2: Flat sheets and Duragrid™ is classified as Type A Category 3.

Sheet Tolerances

Duragrid™ complies with the requirements of AS2908.2

Thermal Conductivity

Duragrid™ panels have relatively low thermal conductivity: R-value. At Equilibrium Moisture content the approximate R-Value of Duragrid™ is; - 0.55 W/m°C.

Fire Resistance

BGC Fibre Cement 9mm has been tested for and passed the Early Fire Hazard Property criteria in compliance with AS/NZS 1530.3 and AS/NZS 3837 and is deemed a Group 1 Material in accordance with the Building Code of Australia (BCA), Volume 1, Specification A2.4; Fire Hazard Properties. AS/NZS 1530.3; Early Fire Hazard Properties.

- / Ignition Index 0
- / Spread of Flame Index 0
- / Heat Evolved Index 0
- / Smoke Developed Index 0-1

Durability

Duragrid™ physical properties ensure it's durability in exposed applications.

- / Duragrid™ panels are immune to permanent water damage in both short and long-term exposure
- / Duragrid™ panels will not rot or burn and are unaffected by termites, air, steam, salt and sunlight
- / Duragrid™ panels are not adversely affected over a temperature range of 0°C to 95°C

A vapour permeable moisture barrier must be installed under the timber or steel batten in accordance with the AS/NZS 4200.2 – 'Pliable building membranes and underlays – Installation' and the vapour permeable moisture barrier manufacturer's guidelines. The vapour permeable moisture barrier should have the following properties:

- / Vapour barrier – low or medium
- / Water barrier – high

A vapour permeable moisture barrier is used to prevent moisture ingress into the frame whilst enabling water vapour built up within the frame space to migrate out.

To ensure the durability of the Durabatten apply a film of polyurethane over the exposed face at the expressed joint.

Weather Resistance / Freeze Thaw

The Duragrid™ facade system conforms to the Building Code of Australia (BCA) requirements for external wall applications. Duragrid™ Facade System has been tested to AS/NZS 4284 Testing of Building Facades.

Duragrid™ subject to freeze/thaw conditions must be painted. Duragrid™ should not be used in situations where it will be in direct contact with snow or ice for prolonged periods.

Sheet Sizes and Weight - Table 1

THICKNESS mm	WEIGHT KG/m ²	WIDTH mm	LENGTH mm			
			1190	1790	2390	2990
9	13.5	590			✓	
		890		✓		
		1190	✓			✓

Weights are based on Equilibrium Moisture Content.

Handling and Storage

Duragrid™ must be stacked flat, up off the ground and supported on equally spaced (max 400mm) level gluts. Care should be taken to avoid damage to the ends, edges and surfaces.

Sheets must be kept dry. When stored outdoors it must be protected from the weather. Sheets must be dry prior to fixing, jointing or finishing.

Coastal Areas

The durability of galvanised nails and screws used for exterior cladding in coastal or similar corrosive environments, including very heavy industrial areas can be as low as 10 years.

For this reason BGC recommend the use of Stainless Steel fasteners within 1km of the coast or other large expanses of salt water.

Accessories available from BGC

*DURABATTEN-PRIMED, HARDWOOD TIMBER	19 x 70 x 3000mm	BGC PRODUCT CODE 491	
	19 x 70 x 2700mm	BGC PRODUCT CODE 490	
HORIZONTAL BACKING STRIP	1190mm	BGC PRODUCT CODE 839	
	2390mm	BGC PRODUCT CODE 841	
	2990mm	BGC PRODUCT CODE 843	
CAVITY VENT STRIP	19 x 2700mm	BGC PRODUCT CODE 480	
SEALANT / ADHESIVE	Sikaflex 11FC 300ml or similar	BGC PRODUCT CODE 485	
	Sikaflex 11FC 600ml or similar	BGC PRODUCT CODE 486	

*Steel battens are also available. Please refer to Duragrid Light Commercial brochure.

Fasteners - Durabatten to frame

Durabatten timber to timber frame

Class 3 Corrosion resistant Ring Shank Nail – 2.8 x 75mm



Paslode ND 50mm 14 Gauge Stainless Steel
If using this option, 2 nails must be used at each fixing point.



Durabatten timber to steel frame

Class 3, 8 x 35mm Wingtek Self Embedding Head Screw,
8 x 40mm Wingtek Self Embedding Head Screw



Durabatten steel to steel frame

Class 3 Hex Head Screw, 12-14 x 20mm



Fasteners - Duragrid™ to Durabatten

Duragrid™ Durabatten timber

C25 304 Stainless Steel Brads



2.8 x 30mm Fibre Cement Nail



No.8 x 10 x 25mm Class 3 Countersunk Wood Screw



Duragrid™ to Durabatten steel

No.8 x 30mm Class 3 Countersunk Self Drilling



DURAGRID™

FACADE SYSTEM

Fasteners

Select fasteners with suitable durability for the prevailing conditions. Please consult your supplier for:

- / Minimum requirements Class 3.
- / Stainless Steel may be required in some applications.

All screw holes must be filled with an epoxy filler such as Megapoxy P1, Hilti CA125 or Hilti CA273 and sanded flush to provide a flat surface for finish coating. When sanding, only sand the screw holes, not the entire sheet surface.

Figure 1

Pre Countersink

When using screws to fasten Duragrid™, pre countersinking is required so that the fastener is 2mm under the sheet surface for filling with epoxy filler.



Design Considerations

The designer should determine the wind pressure for the project and specify the layout, spacing and fixing of the Durabatten to the structure.

The support framing must be designed for a maximum deflection of span / 250 as per AS/NZS1170.

In areas where there is a probability of high wind loading, care should be taken in the design detailing, especially around all openings, corners and other junctions, to ensure the weather resistance of the total system.

Before the Duragrid™ panels and the supporting substructure are installed, particular care should be taken to ensure that all flashing and waterproofing work is complete, including all vapour permeable building wraps and damp proof coursing.

Control Joints

In many cases, control joints will not be required as typical expressed joints permit some differential movement of the Duragrid™ panels and the sub-framing.

It is recommended that the designer consider the need for control joints in the following cases:

- / Mid floor joint
- / Where Duragrid™ crosses a building control joint
- / Where there is likelihood of movement in the sub-framing
- / Continuous lengths greater than 8 metres
- / At a change in the structural substrate; eg masonry to steel framing

Structural movement, vertical and horizontal control joints are required to match existing structural control joints and should reflect through the facade.

Ground Clearance

Figure 2

Ground Clearance and Foundation

Maintain a minimum 150mm clearance to earth or as required by local building regulations.

GTEK™ Wall

Timber Durabatten

Duragrid™

Vapour Permeable Moisture Barrier*

uPVC Cavity Vent Strip

Damp Course*

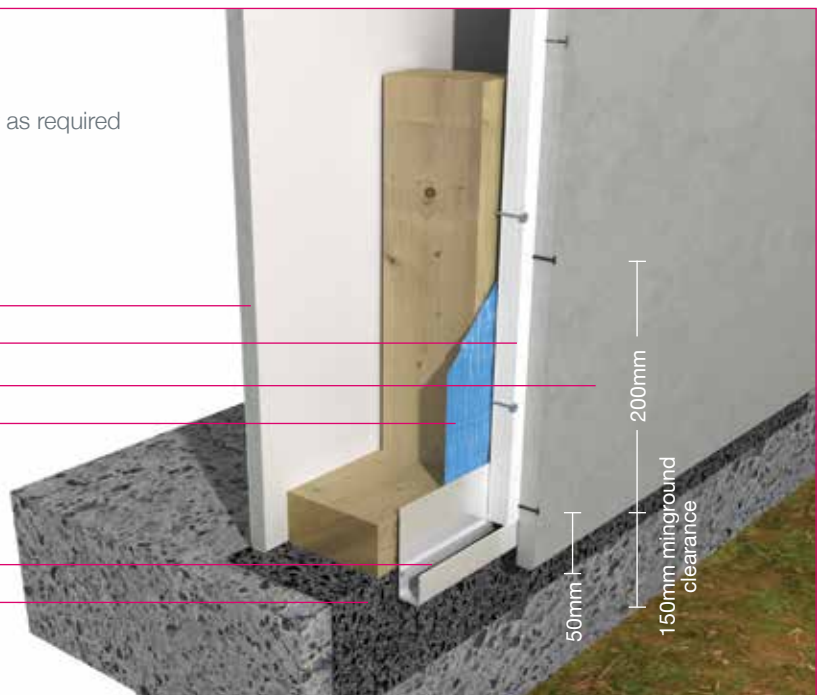

Panel Preparation

For insitu paint finish applications, Duragrid™ panels are supplied sealed with a proprietary sealer applied during manufacture for durability.

Where it is necessary to cut sheets, cutting tools should have a dust extraction system.

Cut edges must be sealed with BGC Edge Sealer or an acrylic coating to eliminate moisture absorption.

A saw blade such as BGC Durablade with a poly crystalline diamond tip specifically designed to cut fibre cement sheets is recommended.

Ensure work area is well ventilated and wear an approved dust mask (AS/NZS1715 and AS/NZS1716) and safety glasses (AS/NZS1337).



Backing Strip Installation & Sealing

At the horizontal joints between the Duragrid™ panels, the Horizontal Backing Strip should be bonded to the back of the Duragrid™ panel to form a socket to which the Duragrid™ panels above are fixed over.

Set the backing strip 2mm from the edge of the Duragrid™ panel. Seal the cut edge with BGC Edge Sealer.

The backing strip can be fixed using:

- / Sikaflex 11FC. **Ensure that the sealant has cured fully before panel installation**
- / 3M 12.7mm VHB4991 or 3M VHB4941 double sided tape. The contact surfaces to be cleaned with 3M HIPA 300 Adhesive cleaner

NOTE: Sikaflex 11FC is the preferred option for fixing the backing strip.

NOTE: Ensure the sealant fills the void in the back of the Horizontal Backing Strip to prevent moisture ingress.

Figure 3
Sealant (Preferred Option for Optimal Adhesion and Sealing) - Front View

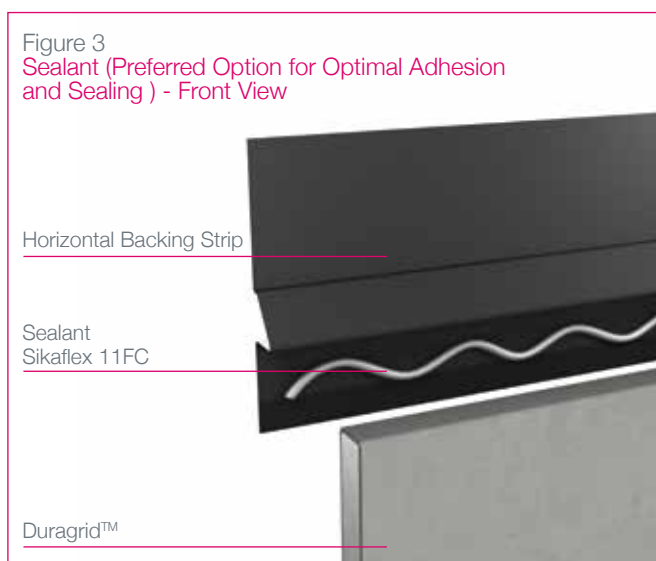

Figure 4
Backing Strip Tape Front View



Figure 5
Backing Strip Installation Rear View

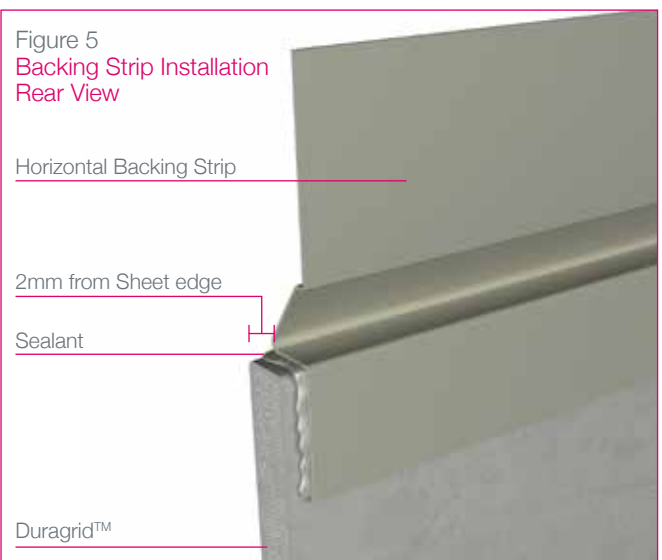
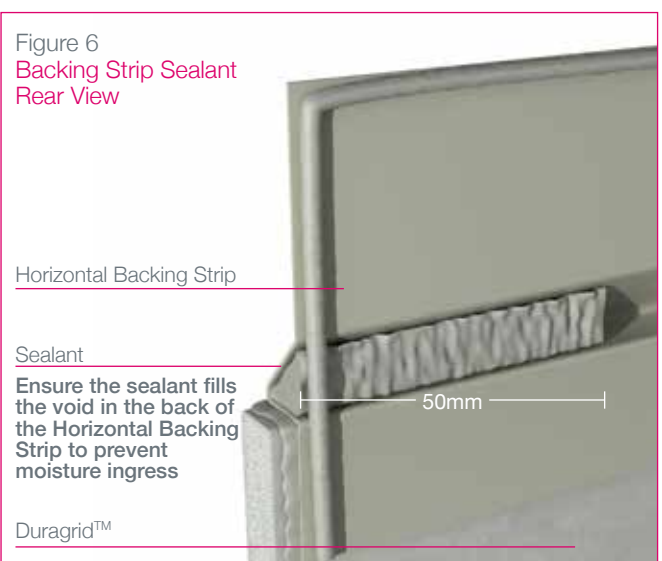

Figure 6
Backing Strip Sealant Rear View



Fastener Spacing - Residential

Fixing Durabatten to Timber Wall Frames

Spans should be approximately equal (within 25%). Battens can be installed either ON stud (batten fixed directly to stud) or OFF stud (batten fixed to noggin).

Durabatten can be fixed on stud or off stud – Refer to Span Table. Off stud fixing is restricted to low wind areas and noggings are required at maximum 850mm centres – Refer to Span Table in all instances.

The vertical expressed joints must coincide with the centre line of the Durabatten. Stud centres may have to be designed to coincide with express joints.

It is recommended not to batten the whole job, but instead batten & install the Duragrid™ panels as you go.

Batten Span/Wind Classification - Table 2

Wind Classification AS4005-2012	Durabatten off stud fix	Durabatten span	Durabatten fixing spacing	Durabatten spacing within 1200mm of corners (mm)	Fixing spacing within 1200mm of corners (mm)	Durabatten spacing elsewhere (mm)	Fixing spacing elsewhere (mm)
N1	OK	850	300	600	200	600	200
N2	OK	850	300	600	200	600	200
N3	OK	850	300	450	200	600	200
N4	NO	n/a	200	450	150	600	200
N5	NO	n/a	200	300	150	450	200
N6	NO	n/a	200	300	150	450	150
C1	OK	800	200	450	200	600	200
C2	NO	n/a	200	450	150	600	200
C3	NO	n/a	200	300	150	450	200
C4	NO	n/a	200	300	150	450	150

NOTE: Durabatten can be fixed off stud in N1, N2, N3, C1 wind classification areas only.

Fixing Duragrid™ to Durabatten

Fix cladding to batten via a continuous 6mm bead of Sikaflex 11FC polyurethane adhesive to all contact surfaces and Brad Nails at 200 centres.

Duragrid™ can be fixed with C25 304 Stainless Brads and Sikaflex 11FC as specified in N1, N2, N3, N4, C1, locations.

Duragrid™ should be screw fixed in other locations.

All calculations include full internal pressurisation as per AS4055-2012.

Deflection of battens limited to a maximum of 200mm.

All framed walls should be constructed to the relevant standards.

Stackbond (no overlap).

Where battens are fixed OFF stud, noggins are to be evenly spaced with maximum centres of 800mm.

Fix timber batten to timber wall frame with:

- / **ON-stud** Class 3 2.8 x 75mm Ring Shank Nails @ 300 centres.
- / **OFF-stud** Fix timber battens to noggins with:
- / Class 3 2.8 x 75mm Ring Shank Nails.
- / C1 (max 1.61kN pullout load).

Fix timber battens to noggins with:

- / Class 3 2.8 x 75mm Ring Shank Nails.
- / Or: Class 3 No. 8 10 x 40mm

Fixing Timber Noggins to Timber Studs

Where noggins support battens, noggins must be securely fixed to studs.

Noggins should not be spaced more than 850mm.

N1-N3

Fix noggins to studs via minimum 2N^o ø3.75 nails at each end.

Framing

Ensure that the frame is square and work from a central datum line. The frame must be straight and true to provide a flush face to receive the panels. BGC recommend a maximum tolerance of 3mm-4mm in any 3000mm length of frame. Duragrid™ will not straighten excessively warped or distorted frames and any warping may still be visible after Duragrid™ is applied.



Figure 7
Frame Straightness

Timber Frame

Use of a timber frame must be in accordance with AS1684 – Residential timber-framed construction and the framing manufacturer's specifications.

Use only seasoned timber. Do not use unseasoned timber as it is prone to shrinkage and can cause sheets and frames to move up. "Timber used for house construction must have the level of durability appropriate for the relevant climate and expected service life conditions including exposure to insect attacks or to moisture which could cause decay" – Reference AS 1684.2

Stud framing members must be a minimum of 70 x 35mm.

Durabatten Installation to Timber

Timber Durabatten

Install Timber Durabatten either off stud or on stud.

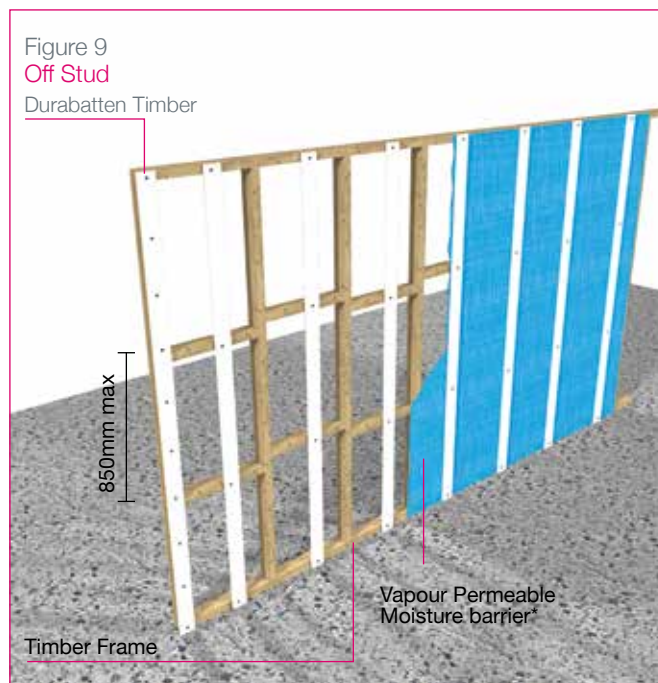
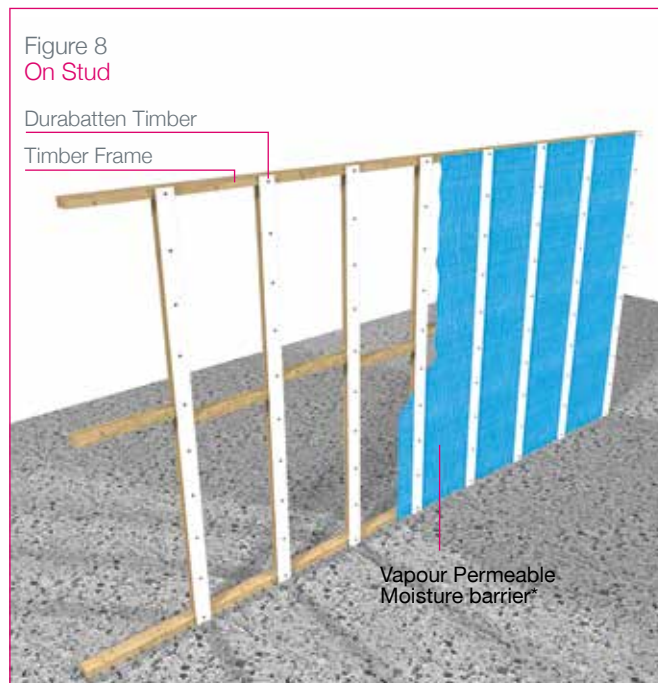

Batten Joining

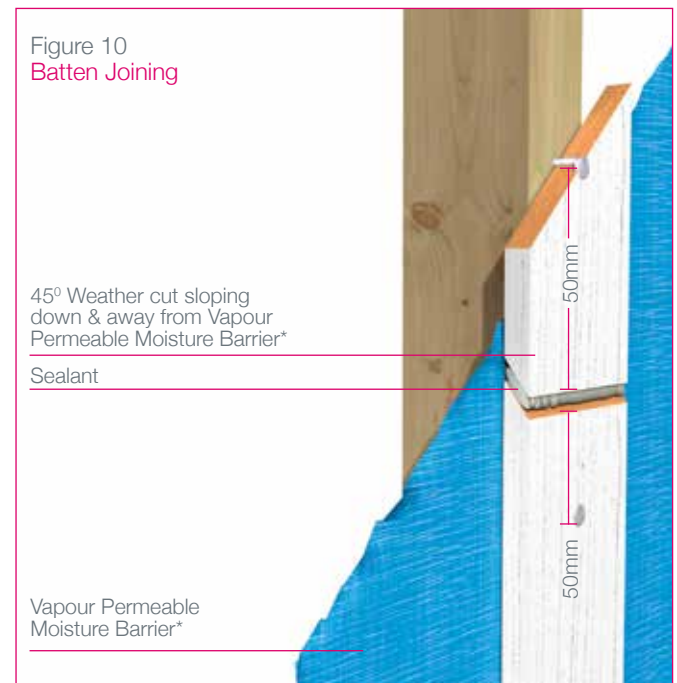

Installation Details

The architectural intent and details of buildings vary from one designer to the next, and the variety of details would be impossible to catalogue.

The detail diagrams following are intended to assist the designer in achieving a high quality weather resistant facade.

The designer should not digress from the specification set out in this manual.

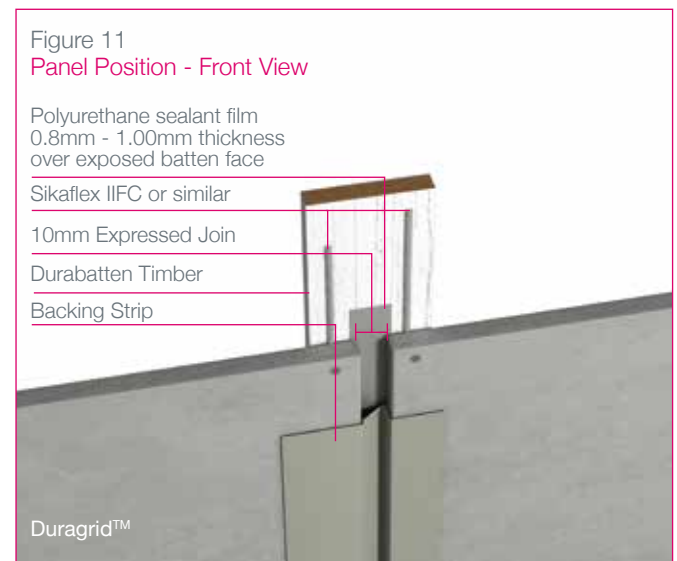

Use the backing strip as a temporary gauge to space the vertical joint of successive boards ensuring a uniform 10mm space between successive panels.

Installation Details

Figure 12
Panel Installation

Durabatten Timber

Using a spirit level ensure panels are plumb and aligned with your datum line

Apply a continuous 6mm diameter bead of joint sealant to the Durabatten at each panel edge

Datum line

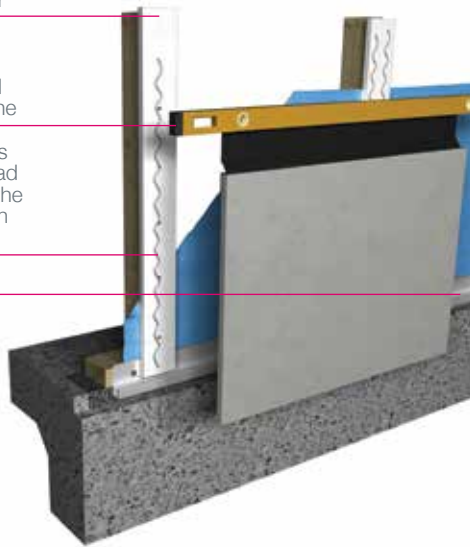

Figure 13 Typical Sealant Application

Sikaflex IIFC or similar

Polyurethane sealant film
0.8mm* - 1.00mm thickness
over exposed batten face.

Durabatten Timber

Vapour Permeable Moisture Barrier*

Continuous 6mm bead of
Sikaflex IIFC or similar

Backing strip
Sikaflex IIFC or similar

Duragrid™

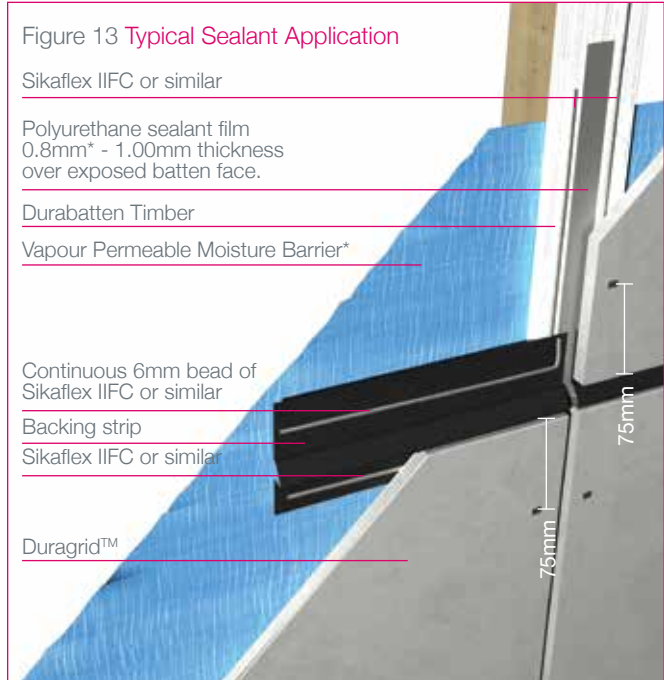

Figure 14
Fastener Spacing

Vapour Permeable Moisture Barrier*

Duragrid™

Horizontal express joint with backing strip behind

Fastener spacing 200mm centres maximum

Refer to Batten Span / Wind Classification table on page 9, for specific fastener spacing centres for different wind zones.

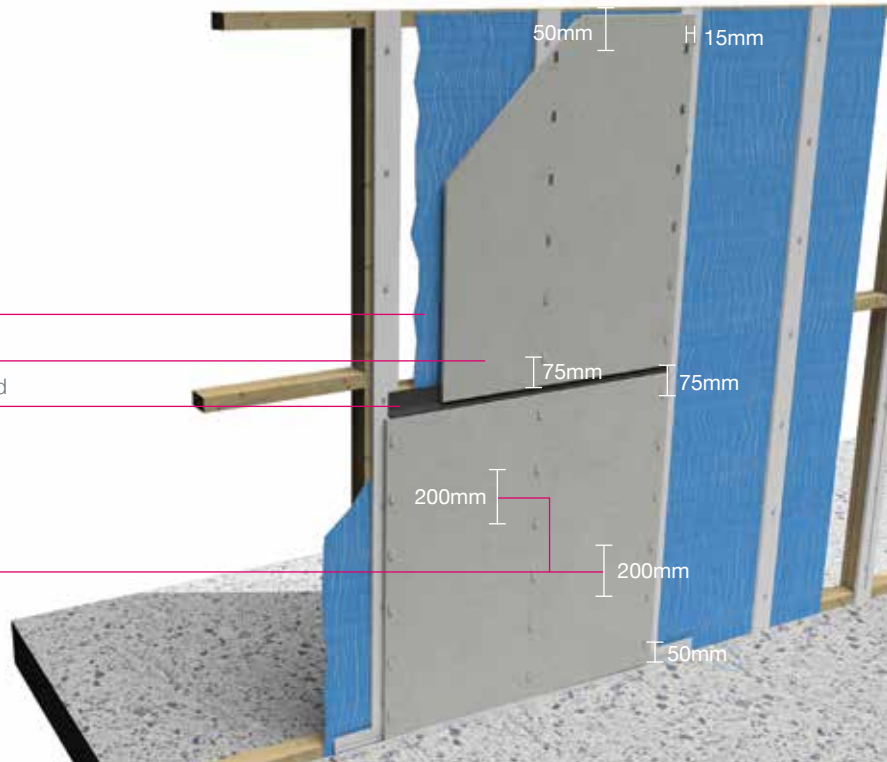

Duragrid™ panels are to be fixed with a continuous 6mm bead of Sikaflex 11FC or similar polyurethane sealant/adhesive to all contact surfaces with required fasteners at specific centres.

Cover the exposed face of battens with a layer of polyurethane sealant to ensure durability of the Durabatten.

Duragrid™ panels should be sealed and fixed one panel at a time. Only apply sealant to the contact surface of the next panel to be fixed.

Installation Details

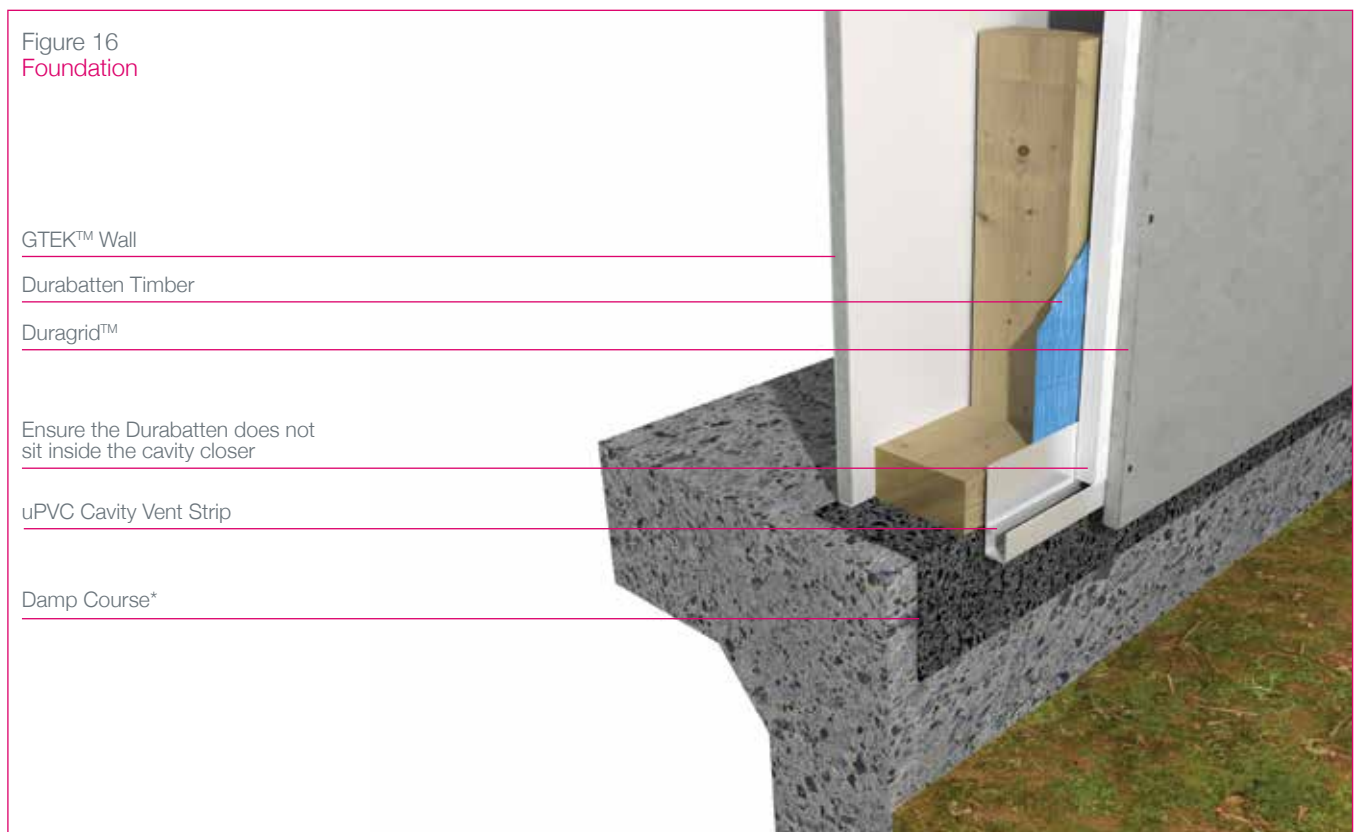
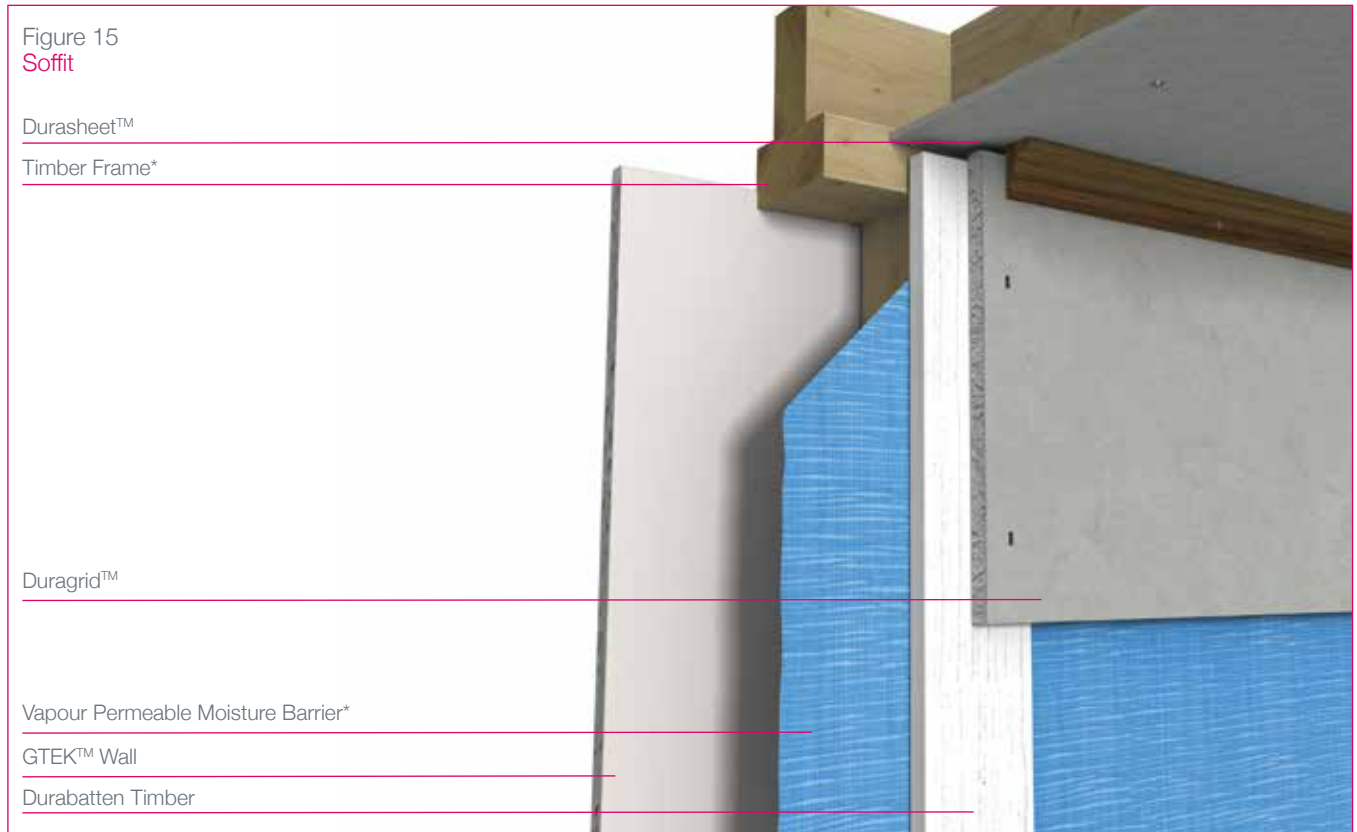

Installation Details

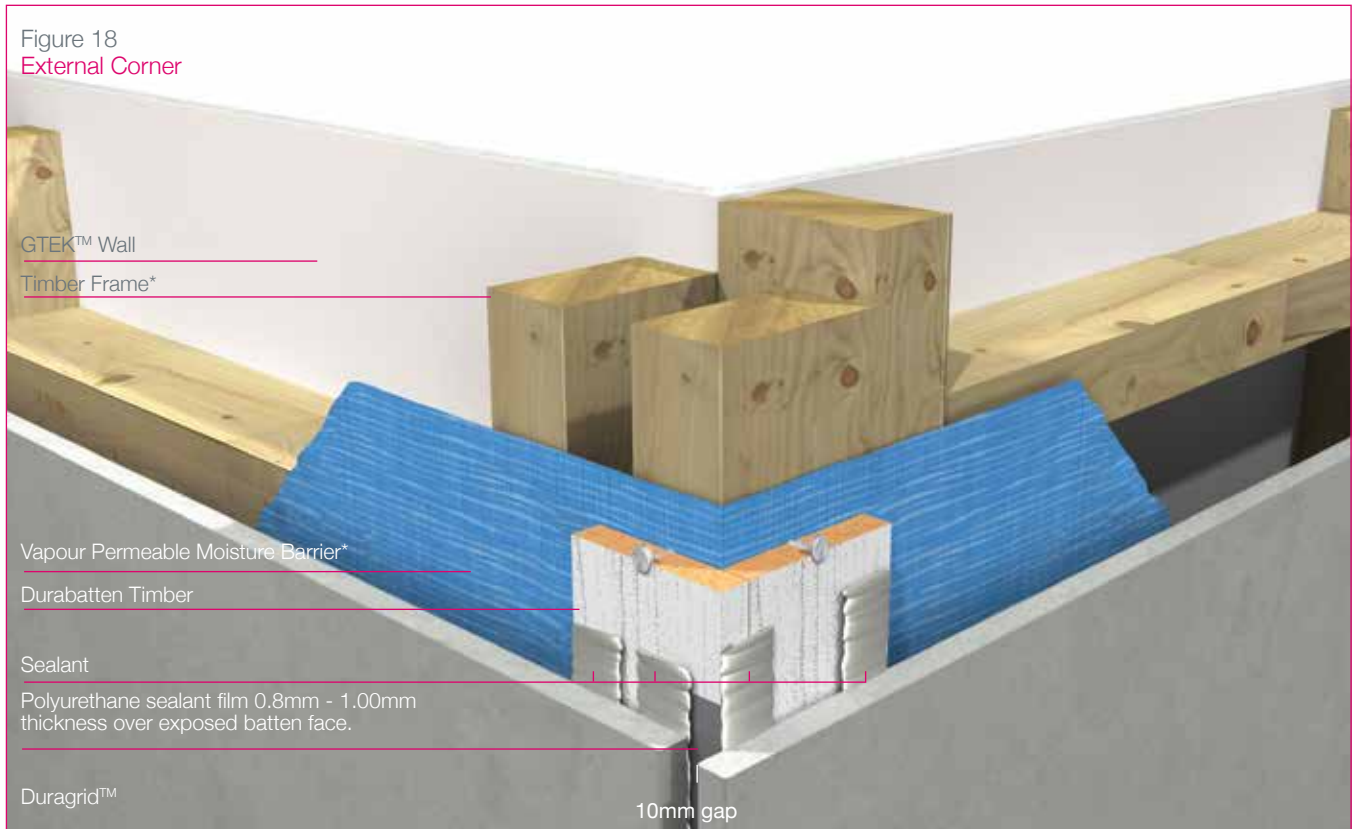
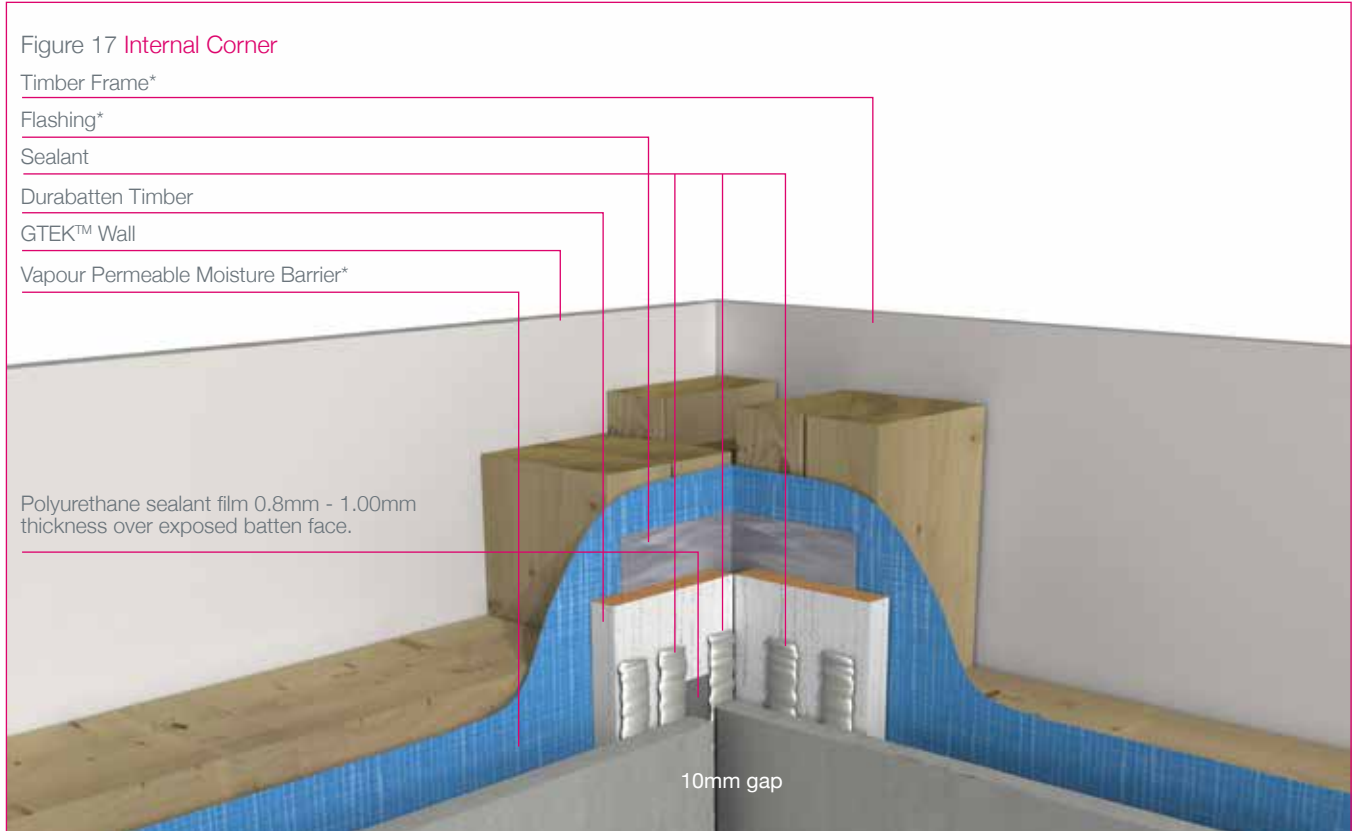

Installation Details

Figure 19
Fastener Position

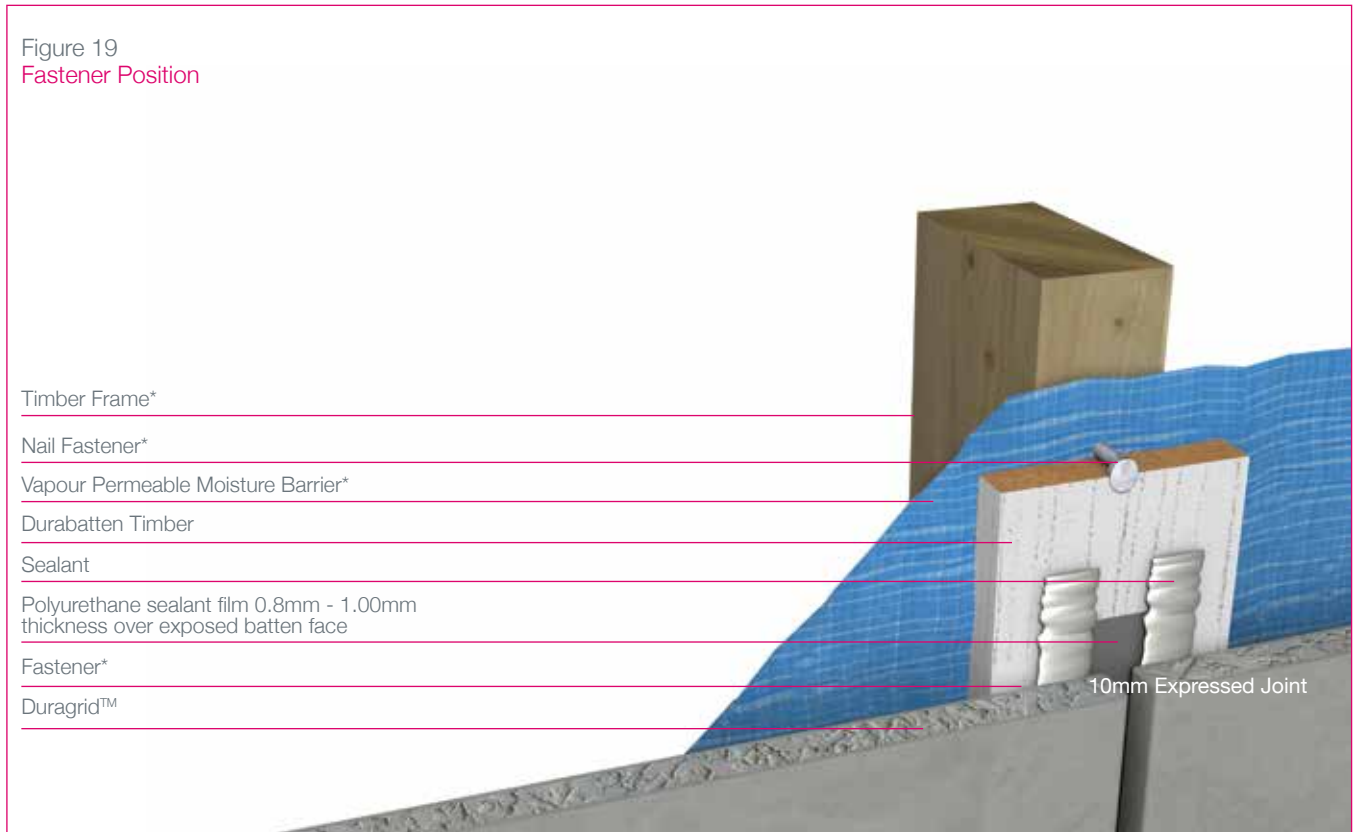

Figure 20
Enclosed Balustrade/Parapet Wall



Penetrations, Window and Door Openings

There are numerous varieties of penetrations, openings, and windows and door treatments available, and each weather proofing detail will be dependent on the material, style and manufacturer's specifications.

The following diagrams are a guide only and the designer should consult with the appropriate manufacturers for the detail design to ensure adequate weather proofing.

Adequate weather proofing of the opening application must be considered by the building designer, in conjunction with the penetration, window and door manufacturer.

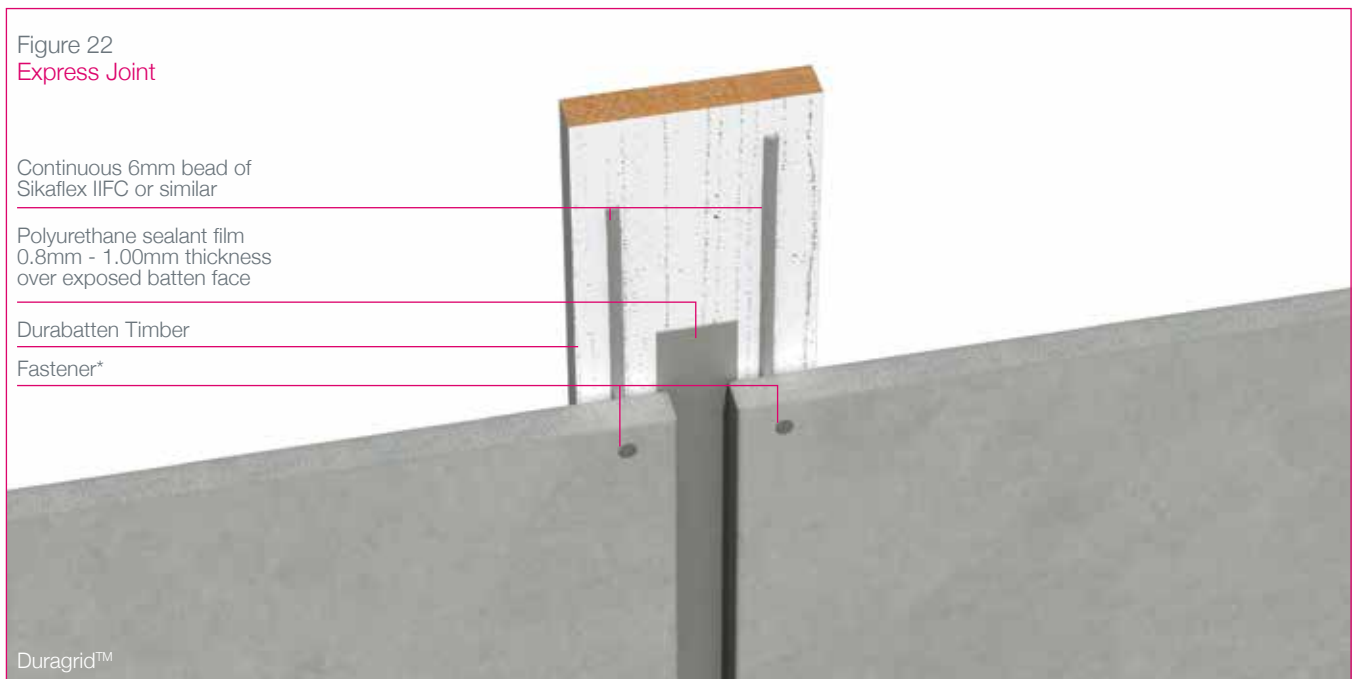
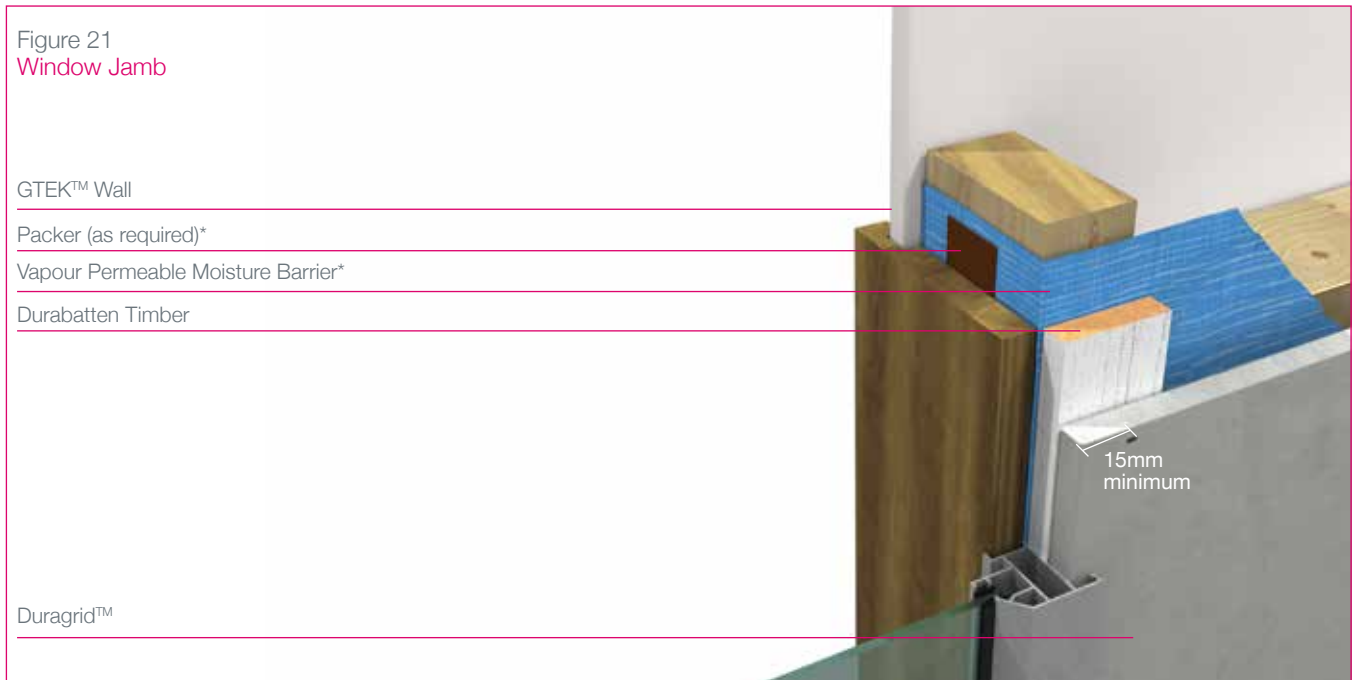

*Components not supplied by BGC

Installation Details

Figure 23
Window Head

- Duragrid™
- GTEK™ Wall
- Durabatten Timber
- Timber Frame*
- Vapour Permeable Moisture Barrier*
- Flashing*
- Packer (as required)*
- Aluminium window joinery*

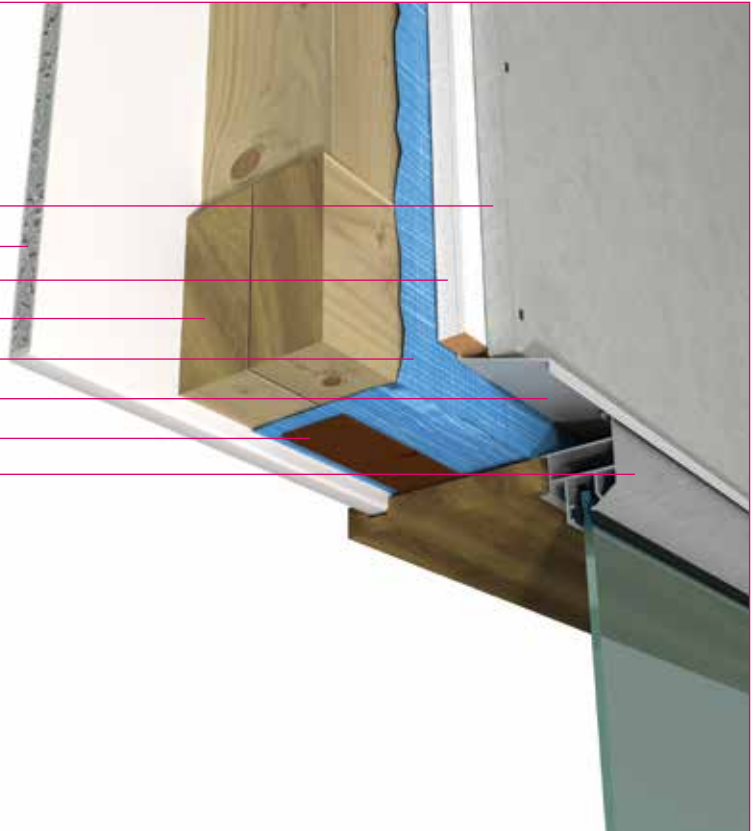
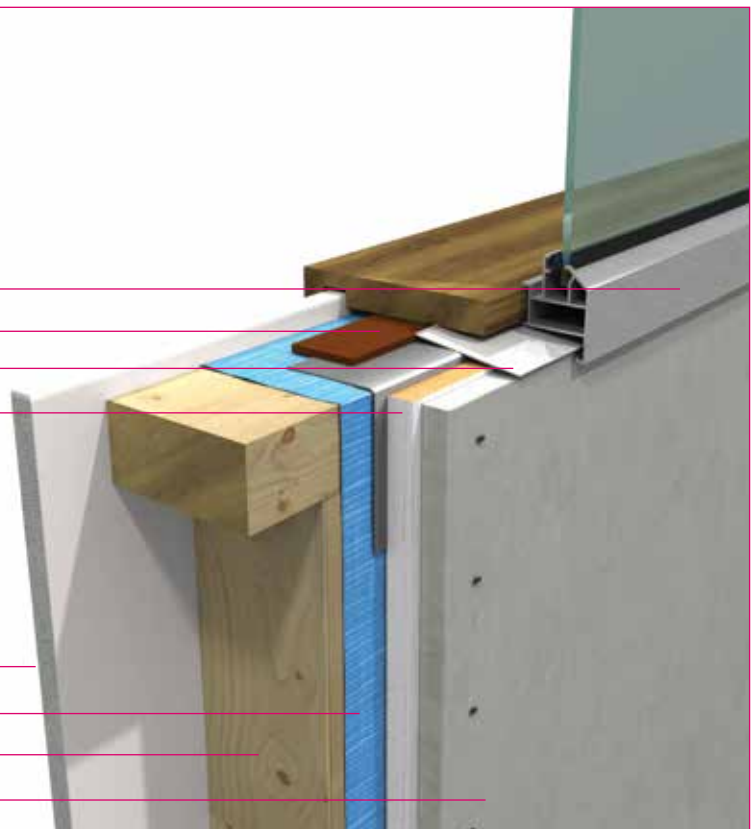

Figure 24
Window Sill

- Aluminium window joinery*
- Packer (as required)*
- Sill tray 5° min slope*
- Durabatten Timber

- GTEK™ Wall
- Vapour Permeable Moisture Barrier*
- Timber Frame
- Duragrid™



Bushfire and Boundary Wall Areas

AS3959:2009 sets out a series of Bushfire threat levels to buildings described as BAL (Bushfire Attack Levels) as follows: BAL-Low, BAL-12.5, BAL-19, BAL-29, BAL-40 or BAL-FZ (Flamezone).

Duragrid™ is eminently suited for both bushfire and boundary wall applications in residential and multi residential buildings.

Bushfire AS3959:2009 Applications

Duragrid™ may be used as a stand-alone product to achieve up to BAL 40 when fixed direct to frame as per the fixing instructions in this manual.

Duragrid™ when used in conjunction with GTEK™ Fire and Wet Area 16mm will comply with the requirements of AS3959:2009 and AS1530.4 to achieve BAL FZ>10.

Boundary/Exterior Walls

Duragrid™ in conjunction with GTEK™ Fire and Wet Area 16mm can achieve both 60/60/60 and 90/90/90 FRL fire ratings from the outside as required by the BCA.

Where an exterior wall is required to achieve 60/60/60 FRL (Fire Resistance Level) from the outside, 1 layer of GTEK™ Fire and Wet Area 16mm installed with Duragrid™ over the Wet Area Fireboard will meet minimum BCA requirements.

Similarly 2 layers of GTEK™ Fire and Wet Area 16mm used in conjunction with Duragrid™ will achieve 90/90/90 from the outside.

GTEK™ Fire and Wet Area 16mm is required to be trowelled with a 'setting' base coat in conjunction with paper tape. Top Coat is not required. Only the final layer of multi layered FRL systems is required to be trowelled.

For more information please contact your nearest BGC Fibre Cement office.

Figure 25
Boundary Wall System

- GTEK™ Wall
- GTEK™ Fire and Wet Area 16mm
- Durabatten Timber
- Vapour Permeable Moisture Barrier*
- Duragrid™

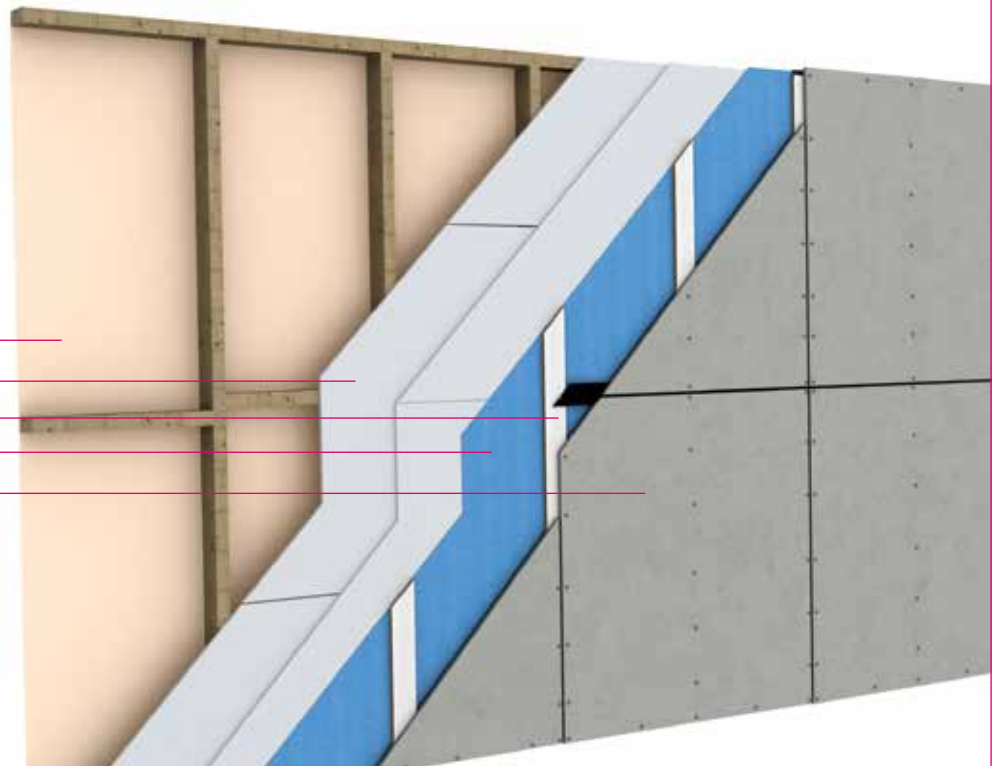

Deemed to Comply

For an up to date and complete list of BGC Products that are 'Deemed to Comply' please refer to www.ntlis.nt.gov.au/deemedto comply

Warranty

We warrant that our products are free from defects caused by faulty manufacture or materials for a period of 15 years from the date of purchase. If you acquire any defective products, we will repair or replace them, supply equivalent replacement products or refund the purchase price within 30 days of receiving a valid claim subject to product inspection and confirmation of the existence of a defect by BGC. We will bear the cost of any such repair, replacement or refund.

This warranty is given by:

BGC Fibre Cement Pty Ltd
121 Bannister Rd Canning Vale WA 6155
Phone 08 9334 4900 Fax 08 9334 4749

To claim under this warranty, you must provide proof of purchase as a consumer and make a written claim (including any costs of claiming) to us at the address specified above within 30 days after the defect was reasonably apparent, or if the defect was reasonably apparent prior to installation, the claim must be made prior to installation. You may not claim under this warranty for loss or damage caused by:

- faulty or incorrect installation by non-BGC installers (BGC's installation procedures are at www.bgcinnovadesign.com.au);
- failure to comply with the Building Code of Australia or any applicable legislation, regulations approvals and standards;
- products not made or supplied by BGC;
- abnormal use of the product; or
- normal wear and tear.

The benefits available under this warranty are in addition to other rights and remedies of the consumer under the law. Our goods come with guarantees that cannot be excluded under the Australian Consumer Law. You are entitled to a replacement or refund for a major failure and for compensation for any other reasonably foreseeable loss or damage.

You are also entitled to have the goods repaired or replaced if the goods fail to be of acceptable quality and the failure does not amount to a major failure.

Terms and Conditions

BGC Fibre Cement's Terms and Conditions of Sale ("Agreement"), as in place and published at the date of this brochure, which are available upon request or on our website at www.bgcinnovadesign.com.au. The purchaser's terms and conditions, howsoever provided, do not form part of the Agreement.

Notes

Lined area for notes, consisting of multiple horizontal dashed lines.

Adelaide
Telephone
08 8250 4962

Sydney
Telephone
02 9709 0600

Brisbane
Telephone
07 3271 1711

New Zealand
Telephone
0011 64 9273 1457

Melbourne
Telephone
03 9392 9444

Technical help line
1300 652 242

Perth
Telephone
08 9334 4900

Exterior products and applications
INNOVA™ RANGE OF PRODUCTS

- DURACOM™** / A compressed fibre cement facade system.
- DURAFLOOR™** / The ultimate flooring product that can be used in both interior and exterior applications.
- DURAGRID™ RESIDENTIAL & DURAGRID™ LIGHT COMMERCIAL /**
A lightweight facade giving a modern and durable finish.
- DURAGROOVE™** / A vertically grooved exterior facade panel.
- DURASCAPE™** / A lightweight exterior facade base sheet with a subtle vertical shadow line.
- NULINE™ PLUS** / A weatherboard style cladding system.
- STONESHEET™** / Purpose designed substrate for stone tile facade.
- STRATUM™** / A range of plank products, each of which can be used as stand-alone products or used together to create a striking exterior cladding solution.
- STRATUM™ ERA** / A traditional, yet contemporary weatherboard.

Exterior products and applications
BGC FIBRE CEMENT RANGE OF PRODUCTS

- DURASHEET™** / Ideal for the cladding of gables and lining of eaves. Can also be used on commercial soffits and cladding on non-impact areas.
- DURAPLANK™** / Available in Smooth, Woodgrain and Rusticated finishes, Duraplank™ is ideal for exterior cladding of upper storey conversions or ground level extensions.
- DURATEX™** / A base sheet used for textured coatings on exterior wall applications.
- DURALINER™ PLUS** / An exterior lining board that is the perfect substrate for tiles and is ideal for wet areas.
- DURALATTICE™** / Square or diamond patterned lattice, suitable for screens, pergolas and fences.
- COMPRESSED** / Used as a domestic, commercial sheet for wet areas, flooring, partitions, exterior decking, fascia and facade cladding.
- DURALUX™ PLUS** / Suitable for exterior applications where it will be sheltered from direct weather.

Interior products and applications
BGC FIBRE CEMENT RANGE OF PRODUCTS

- DURALUX™ PLUS** / An interior lining board suitable for ceilings and soffits.
- DURALINER™ PLUS** / An interior lining board, this is the perfect substrate for tiles and is ideal for wet areas.
- CERAMIC TILE UNDERLAY** / A substrate for ceramic and slate floor tiles.
- VINYL CORK FLOOR COVERINGS** / A substrate for vinyl floors.

bgcinnovadesign.com.au