

AUGUST 2016



STRATUM™
CLADDING SYSTEM



BGC | Fibre Cement

AUSTRALIAN OWNED & MANUFACTURED
WWW.BGCINNOVADESIGN.COM.AU

INTRODUCING INNOVA™

BGC'S STUNNING RANGE OF FACADE, LINING AND FLOORING PRODUCTS, INNOVA™ WILL MOVE YOU TO REASSESS YOUR CONCEPT OF EXCELLENCE IN FACADES AND FLOORING SYSTEMS. DURABLE AND DYNAMIC, FRESH AND CONTEMPORARY, INNOVA™ IS ALREADY TURNING INDUSTRY HEADS. NOW LET THE INNOVA™ RANGE OF CLADDING AND FLOORING PRODUCTS BREATHE NEW LIFE INTO YOUR CREATIVITY AND PROJECT SPECIFICATION.



A VIBRANT, INNOVATIVE ALTERNATIVE TO TRADITIONAL WEATHERBOARDS, BGC STRATUM™ IS AN ENDLESSLY ADAPTABLE RANGE OF PLANK PRODUCTS. CHOOSE ONE STRATUM™ PROFILE AS A STANDALONE, OR MIX'N'MATCH TWO OR THREE TO CREATE EYE CATCHING AND ORIGINAL INNOVA™ EXTERIOR CLADDING.

- / STRATUM™ 300MM IS A WIDE PLANK WITH A 16MM HORIZONTAL JOINT
- / STRATUM™ DUO 300MM IS A WIDE PLANK WITH A 16MM CENTRE GROOVE AND THE LOOK OF TWO SLIMMER PLANKS
- / STRATUM™ TRIO 300MM IS A WIDE PLANK WITH 2 HORIZONTAL 16MM GROOVES;
- / STRATUM™ CONTOUR 170MM IS A SLIMMER PLANK WITH A 2MM INDENTATION AT THE TOP OF EACH PLANK.

STRATUM™ CLADDING SYSTEM

- / EASY SHIPLAP JOINING
- / FACTORY SEALED, READY FOR PAINTING
- / QUICK, SIMPLE INSTALLATION:
MANUAL NAILING, GUN NAILING
OR SCREW FIXING



CONTENTS

PRODUCT DESCRIPTION	/ 5
ADVANTAGES	/ 5
ENERGY EFFICIENCY CONSIDERATIONS	/ 5
PRODUCT INFORMATION	/ 5
FIRE RESISTANCE	/ 5
PLANK TOLERANCES	/ 5
PLANK SIZES AND MASS	/ 5
DURABILITY	/ 6
THERMAL CONDUCTIVITY	/ 6
CUTTING AND DRILLING	/ 6
HANDLING AND STORAGE	/ 6
ACCESSORIES	/ 7
FASTENERS	/ 8
PLANK COVERAGE	/ 8
COASTAL AREAS	/ 8
FRAMING	/ 9
MAXIMUM STUD AND FASTENER SPACING	/ 9
INSTALLATION DETAILS	/ 10-20
THERMAL BREAKS	/ 21
BUSHFIRE & BOUNDARY WALL AREAS	/ 22
PAINTING	/ 23
MAINTENANCE	/ 23
DEEMED TO COMPLY	/ 23
WARRANTY	/ 23

PRODUCT DESCRIPTION

Stratum™ features a shiplap horizontal joining system making it quick and simple to achieve a classic yet contemporary look. With 4 different profiles available, there is sure to be a profile to suit any project.

Stratum™ can be used for exterior cladding on low to medium rise buildings or for a different twist, can be used to create a stunning interior feature wall.

Stratum™ is not subject to timber rot, decay, cracking, twisting or white ant damage and will not support combustion. The result is a safer, more durable cladding that requires minimum maintenance.

ADVANTAGES

- / Shiplap joining system makes Stratum™ planks quick and simple to install
- / Quick and easy to cut, handle and install
- / Acrylic sealed, ready for painting
- / Durable and low maintenance

ENERGY EFFICIENCY CONSIDERATIONS

Energy efficiency requirements have been introduced into the Building Code of Australia (BCA) for both commercial and residential buildings. Thermal heat transfer into and out of the building envelope will effect the running cost of the building and careful consideration of thermal heat transfer needs to be addressed by the architects, engineers and building designers. Thermal bridging through steel framing will diminish the total R-Value; thermal conductance, of the wall. Thermal breaks are required for steel framed buildings and should be installed between the stud sections and the Stratum™ planks. Thermal break tapes should have a minimum R-Value of 0.2.

PRODUCT INFORMATION

Stratum™ is manufactured from Portland cement, finely ground silica, cellulose fibres and water. Weatherboards are cured in a high-pressure steam autoclave to create a durable, dimensionally stable product.

Stratum™ is manufactured to the Australian / New Zealand Standard AS/NZS 2908.2-2000 Cellulose-Cement Products, Part 2: Flat sheets and Stratum™ is classified as Type A-Category 2.

FIRE RESISTANCE

BGC Fibre Cement products have been tested in accordance to Australian Standard AS1530.3.

These tests deemed the following Early Fire Hazard Indices:

- / Ignitability Index 0
- / Spread of Flame Index 0
- / Heat Evolved Index 0
- / Smoke Developed Index 0-1

PLANK TOLERANCES

/ Stratum™ complies with the requirements of AS 2908.2

PLANK SIZES AND WEIGHT-TABLE 1

THICKNESS mm	WEIGHT KG/m ²	WIDTH mm	FINISH	LENGTH mm
12	5.2	300	Stratum™	4200
	5.2		Stratum™ Duo	
	5.2		Stratum™ Trio	
10	2.5	170	Stratum™ Contour	

Weights are based on Equilibrium Moisture Content.

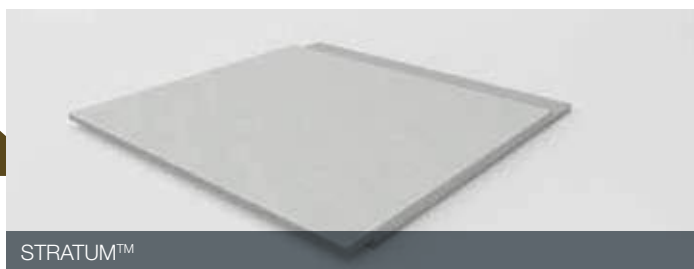

STRATUM™

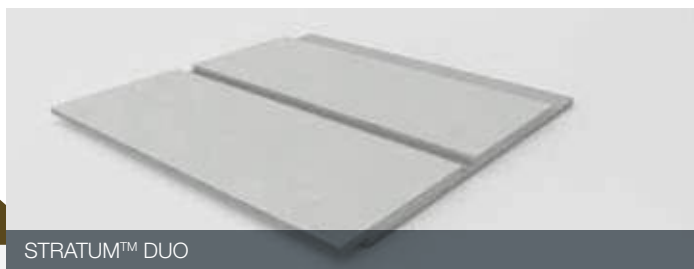

STRATUM™ DUO

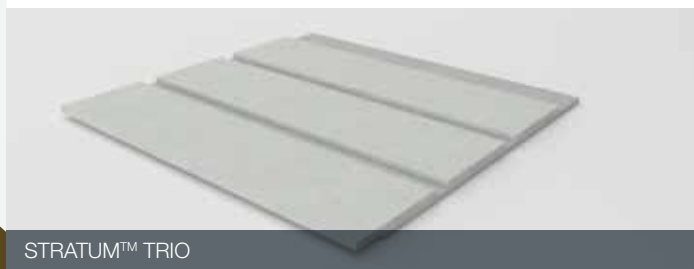

STRATUM™ TRIO



STRATUM™ CONTOUR

DURABILITY

Stratum™ physical properties make it a very durable product.

- / Stratum™ is immune to permanent water damage in both short and long-term exposure.
- / Stratum™ will not rot or burn and is unaffected by termites, air, steam, salt and sunlight.
- / Stratum™ is not adversely affected over a temperature range of 0°C to 95°C.

Vapour permeable sarking must be installed under the timber or steel batten in accordance with the AS/NZS 4200.2 – 'Pliable building membranes and underlays – Installation' and the sarking manufacturers' guidelines. The sarking should have the following properties

- / Vapour barrier – low or medium
- / Water barrier – high

Vapour permeable sarking is used to prevent moisture ingress by acting as a drainage plane whilst enabling water vapour build up from inside the frame to escape.

THERMAL CONDUCTIVITY

Stratum™ planks have relatively low thermal conductivity. At Equilibrium Moisture content the approximate thermal conductivity of Stratum™ is; - 0.25 W/m°C.

WEATHER RESISTANCE/FREEZE THAW

Stratum™ conforms to the Building Code of Australia (BCA) requirements for external wall applications.

Stratum™ that is subject to freeze/thaw conditions must be painted. Stratum™ should not be used in situations where it will be in direct contact with snow or ice for prolonged periods.

CUTTING AND DRILLING

Stratum™ may be cut to size on site. If using power tools for cutting, drilling or sanding they must be fitted with appropriate dust collection devices or alternatively an approved (P1 or P2) dust mask and safety glasses shall be worn. It is recommended that work always be carried out in a well ventilated location.

The most suitable cutting methods are:

- / **DURABLADE**
180mm Diameter.
This unique cutting blade is ideal for cutting Fibre Cement. Can be fitted to a 185mm circular saw, ie Makita or similar. Please ensure safe working practices when using.



- / **NOTCHING**
Notches can be made by cutting the two sides of the notch. Score along the back edge then snap upwards to remove the notch.

- / **DRILLING**
Use normal high-speed masonry drill bits. Do not use the drill's hammer function. For small round holes, the use of a hole-saw is recommended. For small rectangular or circular penetrations, drill a series of small holes around the perimeter of the cut out. Tap out the waste piece from the sheet face while supporting the underside of the opening to avoid damage. Clean rough edges with a rasp.

Large rectangular openings are formed by deeply scoring the perimeter of the opening. Next, form a hole in the centre of the opening (refer method above) then saw cut from the hole to the corners of the opening. Snap out the four triangular segments. Clean rough edges with a rasp. (see method above)

HANDLING AND STORAGE

Stratum™ must be stacked flat, up off the ground and supported on equally spaced (max 400mm) level gluts. Care should be taken to avoid damage to the ends, edges and surfaces.

Planks must be kept dry. When stored outdoors it must be protected from the weather. Planks must be dry prior to fixing, jointing or finishing.

ACCESSORIES AVAILABLE FROM BGC - TABLE 2

INTERNAL ALUMINIUM CORNER FOR STRATUM™, STRATUM™ DUO AND STRATUM™ TRIO. (May also be used for Stratum™ Contour)	3000mm x 17mm profile	BGC Product Code INTCNR17	
EXTERNAL ALUMINIUM CORNER FOR STRATUM™, STRATUM™ DUO AND STRATUM™ TRIO. (May also be used for Stratum™ Contour)	3000mm x 17mm profile	BGC Product Code EXTCNR17	
INTERNAL ALUMINIUM CORNER FOR STRATUM™ CONTOUR (recommended)	3000mm x 36mm profile	BGC Product Code INTCNR36	
EXTERNAL ALUMINIUM CORNER FOR STRATUM™ CONTOUR (recommended)	3000mm x 36mm profile	BGC Product Code EXTCNR36	
STARTER STRIP STRATUM™ CONTOUR	3000mm	BGC Product Code 680	
EPDM FOAM GASKET STRIP	25m	BGC Product Code 845	
SEALANT	Sikaflex FC11 OR SIMILAR	BGC Product Code 485	

FASTENERS

STRATUM™ TO TIMBER FRAME

FACE FIXING

2.8 x 50mm Fibre Cement Nail



50mm Cladpast 2.87mm Class 3



50mm Deckfast Type D 2.5mm head



Paslode ND 50mm 14 Gauge Stainless Steel



CONCEALED FIXING

40mm Fibre Cement Nail



STRATUM™ TO STEEL FRAME

FACE FIXING - STEEL FRAME BMT 0.75-1.6mm

32mm Quick drive Screw



Buildex 8 x 18 x 35 SEH Wingteks or similar



FACE FIXING - STEEL FRAME BMT 0.5-0.75mm

Fibre Zip M5 - 18 x 30mm



STRATUM™ PLANK COVERAGE - TABLE 3

NO. OF PLANKS	STRATUM™, STRATUM™ DUO & STRATUM™ TRIO	STRATUM™ CONTOUR
	PLANK SIZE 4200 x 300 x 12mm	PLANK SIZE 4200 x 170 x 10mm
	PLANK OVERLAP 24mm EFFECTIVE COVER PER PLANK 4200 x 276mm OR 1.159m ²	PLANK OVERLAP 29mm EFFECTIVE COVER PER PLANK 4200 x 141mm OR 0.592m ²
1	300	170
2	576	311
3	852	452
4	1128	593
5	1404	734
6	1680	875
7	1956	1016
8	2232	1157
9	2508	1298
10	2784	1439
11	3060	1580
12	3336	1721
13	3612	1862
14	3888	2003
15	4164	2144
16	4440	2285
17	4716	2426
18	4992	2567
19	5268	2708
20	5544	2849

Table 3 is provided to assist in calculating the number of planks required to cover a given wall height.

For triangular areas such as Gable ends, halve the quantities derived for a rectangular wall then add 10% to cover off cuts.

PRE COUNTERSINK

When using screws to fasten Stratum™, pre countersinking is suggested so that the fastener is 2mm under the plank surface for filling with epoxy filler and then finished with BGC Exterior and Wet Area Top Coat.

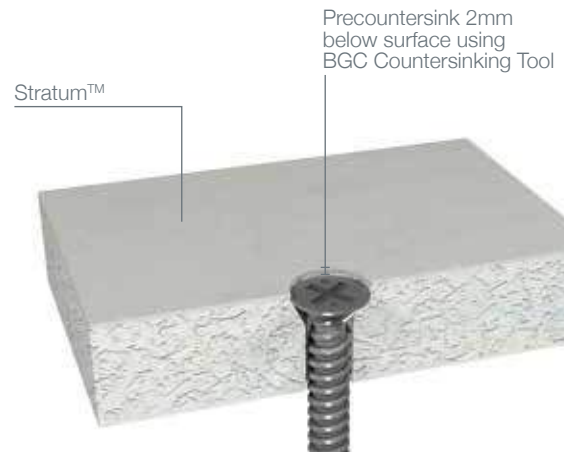

When nails are used they should be driven flush with the sheet face.

COASTAL AREAS

The durability of galvanised nails and screws used for exterior cladding in coastal or similar corrosive environments can be as low as 10 years.

For this reason BGC recommend the use of stainless steel fasteners within 1km of the coast or other large expanses of salt water.

MAXIMUM STUD SPACING TABLE 4

STRATUM™, STRATUM™ DUO & STRATUM™ TRIO FIXED TO TIMBER				STRATUM™, STRATUM™ DUO & STRATUM™ TRIO FIXED TO STEEL			
Wind Class as per AS4055-2012	Stud spacing within 1200mm of corners (mm)	Stud spacing greater than 1200mm from corner	FIXING NOTES	Wind Class as per AS4055-2012	Stud spacing within 1200mm of corners (mm)	Stud spacing greater than 1200mm from corner	FIXING NOTES
N1	600	600	2 brad fasteners @150mm centres or concealed nail fixing	N1	600	600	Concealed screw fixing
N2	600	600		N2	600	600	
N3	Brad Fixing	450	600	N3	600	600	1 face fixed and 1 concealed screw fixing
	Nail Fixing	600	600				
N4	450	600	1 face fixed nail and 1 concealed nail fixing	N4	450	600	
N5	450	450		N5	450	450	
N6	300	450		N6	300	450	
C1	600	600		C1	600	600	
C2	450	600		C2	450	600	
C3	450	450		C3	450	450	
C4	300	450		C4	300	450	

Notes // Panel join may be located 'off stud' when away from corners - for wind classes N1-N3 only
 All other panel joins to be located 'on stud'
 Where panel join is located 'off stud', studs adjacent to the join require a concealed and face fastener

STRATUM™ CONTOUR FIXED TO TIMBER		
Wind Class as per AS4055-2012	Stud spacing within 1200mm of corners (mm)	Stud spacing greater than 1200mm from corner
N1	600	600
N2	600	600
N3	450	450
N4	450	450
N5	300	450
N6	250	300
C1	450	450
C2	450	450
C3	300	450
C4	250	300

STRATUM™ CONTOUR FIXED TO STEEL		
Wind Class as per AS4055-2012	Stud spacing within 1200mm of corners (mm)	Stud spacing greater than 1200mm from corner
N1	600	600
N2	600	600
N3	450	450
N4	450	450
N5	300	450
N6	300	300
C1	450	450
C2	450	450
C3	300	450
C4	300	300

CONSTRUCTION DETAILS

FRAMING

Stratum™ is designed to be installed horizontally to both timber and lightweight steel frames.

Ensure that the frame is square and work from a central datum line. The frame must be straight and true to provide a flush face to receive the panels.

BGC suggest a maximum tolerance of 3mm-4mm in any 3000mm length of frame.

Stratum™ will not straighten warped or distorted frames and any warping may still be visible after Stratum™ planks are applied. Warped framing will require remedial action.

TIMBER FRAMING

Use of a timber frame must be in accordance with AS1684 – Residential timber-framed construction and the framing manufacturers' specifications.

Use only seasoned timber. Do not use unseasoned timber as it is prone to shrinkage and can cause planks and frames to move.

"Timber used for house construction must have the level of durability appropriate for the relevant climate and expected service life conditions including exposure to insect attacks or to moisture which could cause decay" – Reference AS 1684.2

LIGHT WEIGHT STEEL FRAMING

Use of steel frame must be in accordance with AS3623 – Domestic metal framing and the framing manufacturers' specifications.

Framing members must have a Base Metal Thickness (BMT) between 0.55 to 1.6mm. The steel framing must have the appropriate level of durability required to prevent corrosion.

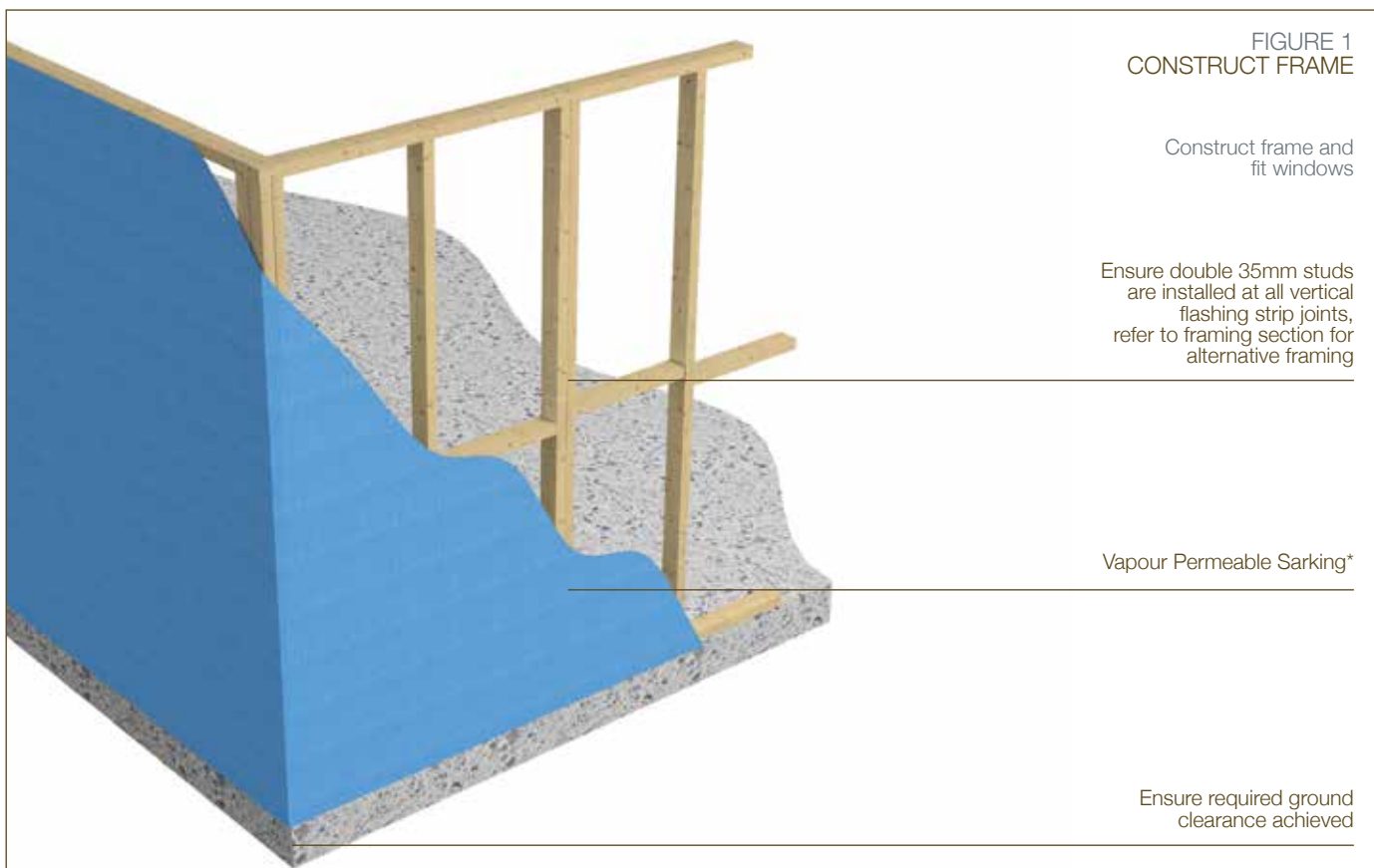

*Components not supplied by BGC

INSTALLATION DETAILS

FIGURE 2
SLAB DETAIL / STRATUM™ / STRATUM™ DUO
/ STRATUM™ TRIO

Vapour Permeable Sarking*

Frame*

Stratum™

Fastener*

Slab*

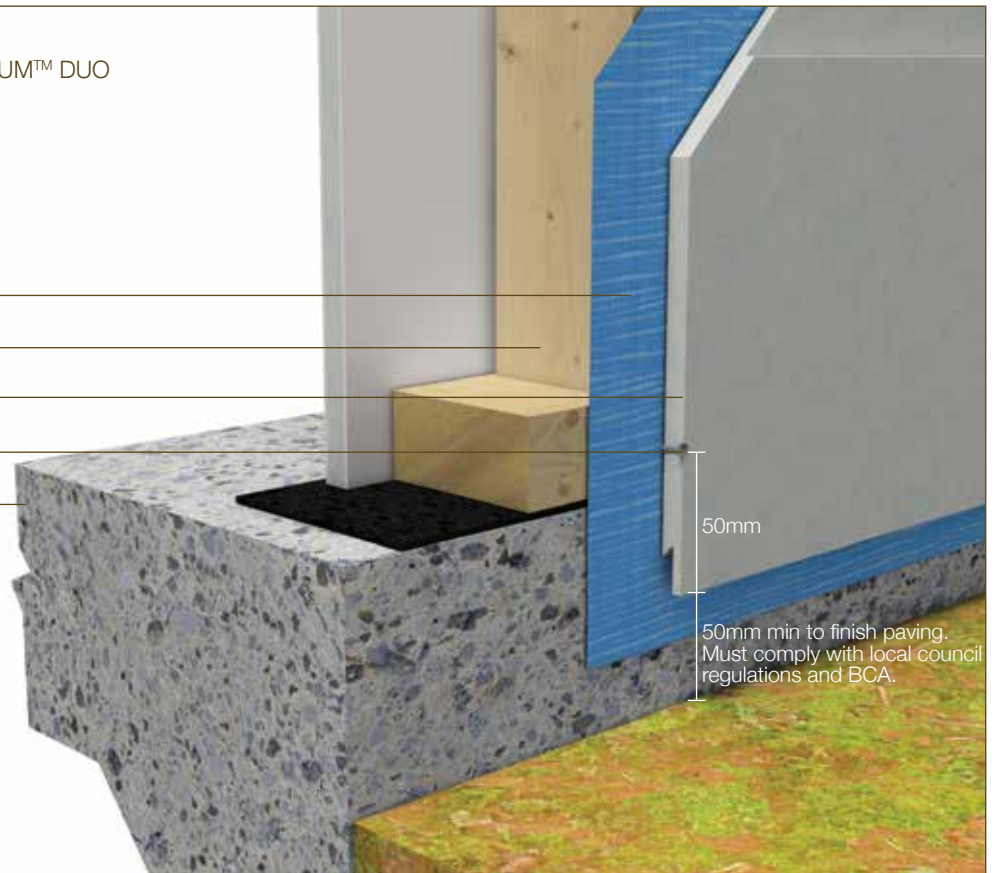

FIGURE 3
SLAB DETAIL / STRATUM™ CONTOUR

Fastener*

Vapour Permeable Sarking*

Frame*

Stratum™ Contour

Starter Strip

Slab*



*Components not supplied by BGC

INSTALLATION DETAILS

FIGURE 4 STRATUM™ / STRATUM™ DUO / STRATUM™ TRIO ON STUD JOINTING

Double
35mm
Framing

EPDM Foam
Gasket

Vapour Permeable
Sarking*

3-10mm gap

Stratum™

FIGURE 5 STRATUM™ / STRATUM™ DUO / STRATUM™ TRIO ON STUD JOINTING

Bond Break
Tape*

Vapour Permeable
Sarking*

20mm

20mm

Leave 3-10mm gap
Apply continuous bead
of paintable sealant

Stratum™

FIGURE 6 STRATUM™ / STRATUM™ DUO / STRATUM™ TRIO OFF STUD JOINTING

Vapour Permeable Sarking*

Apply a 6mm bead
of paintable sealant to edge as
shown. Ensure all surfaces are
free of dirt and grease before
sealing

Stratum™

Off stud joining is suitable up to
N3 Wind Zone.

Fixing of Stratum™ N4 and above
must be fixed on stud.

*Components not supplied by BGC

INSTALLATION DETAILS

FIGURE 7 STRATUM™ CONTOUR
OFF STUD FILLED JOINT

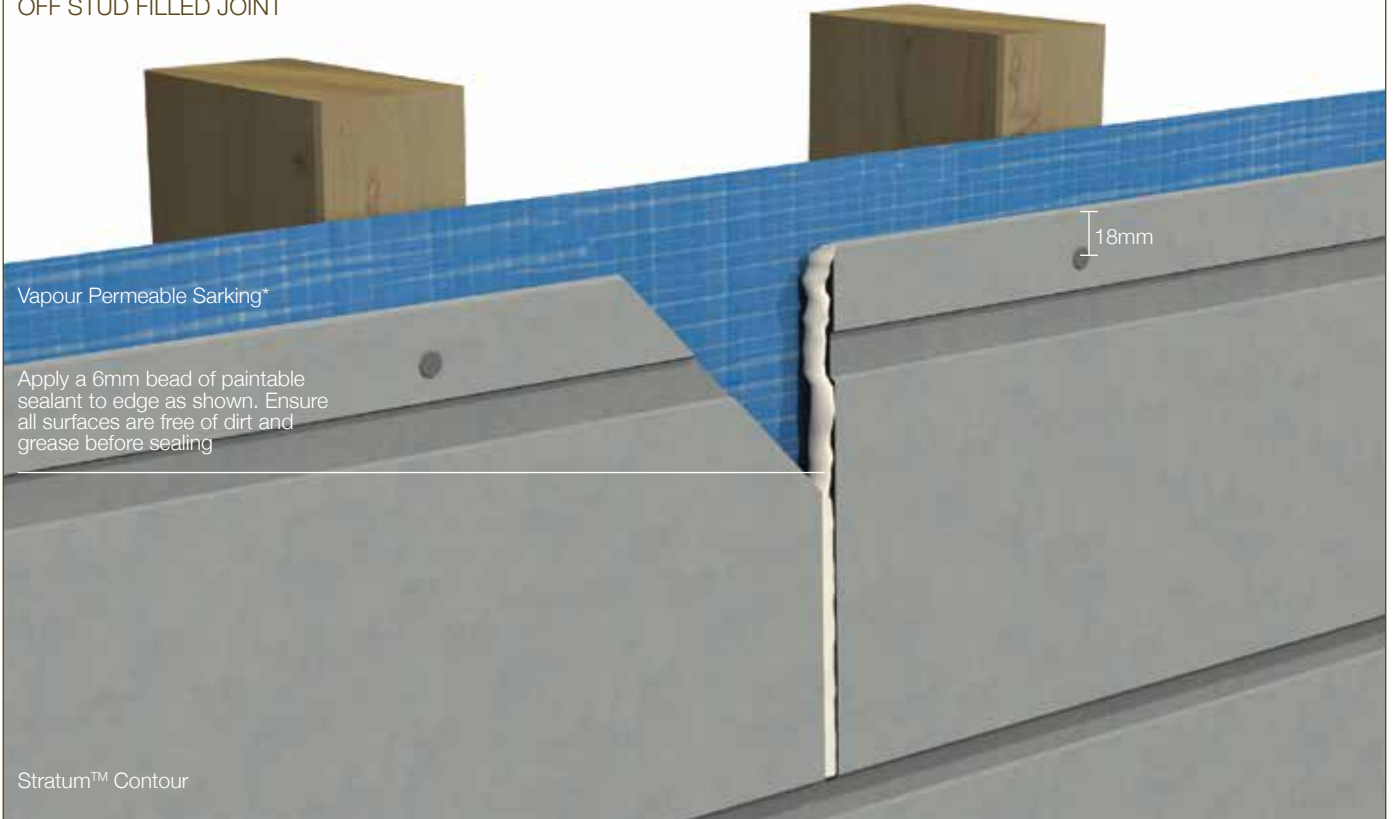

*Components not supplied by BGC

INSTALLATION DETAILS

FIGURE 8
STRATUM™ / STRATUM™ DUO / STRATUM™ TRIO
FACE FIXING

Stud*

Vapour Permeable Sarking*

TIMBER FRAME / HAND NAILING

Use 50mm minimum class 3 fibre cement nails.

TIMBER FRAME / GUN NAILING

Use a minimum class 3 50mm long coil nail or
50mm Deckfast type D head 2.5mm face head.

STEEL FRAME / SCREW FIXING

Use minimum class 3 32mm screws.
Buildex: Fibre Zip or Wingtek. (refer pg8).

N1-N2 Concealed fastener

All other wind zones a concealed fastener
and facefastener 50mm from the bottom
of the overlapping board.

Fastener

Stratum™

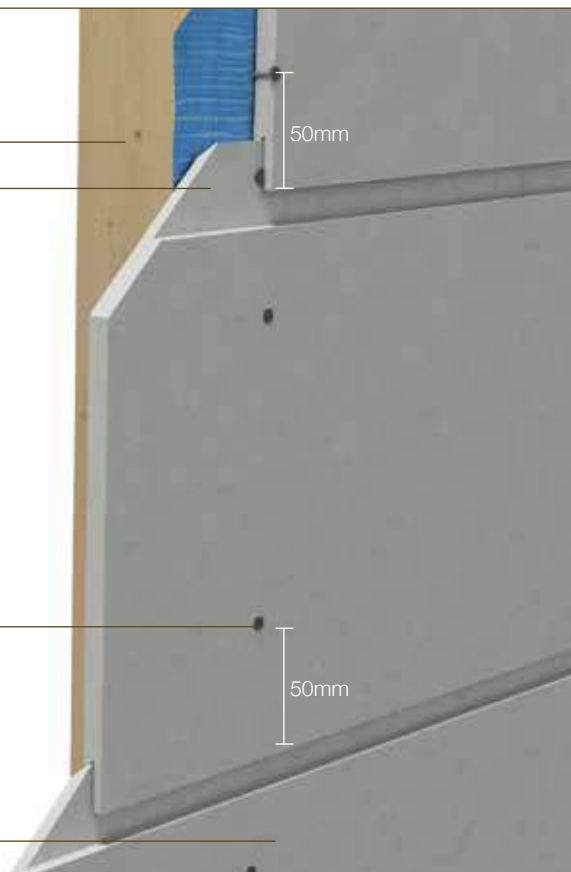

FIGURE 9
STRATUM™ / STRATUM™ DUO / STRATUM™ TRIO CONCEALED FIXING

Stud*

Vapour Permeable Sarking*

TIMBER FRAME / HAND NAILING

Use 40mm minimum class 3 fibre cement.

TIMBER FRAME / GUN NAILING

GUN NAILING IS SUITABLE ONLY FOR FACE FIXING
AND CANNOT BE USED FOR CONCEALED FIXING.

STEEL FRAME / SCREW FIXING

Use minimum class 3 32mm screws.
Buildex FibreZip or Wingtek.

Suitable for N1, N2 Wind Zones only.

Stratum™

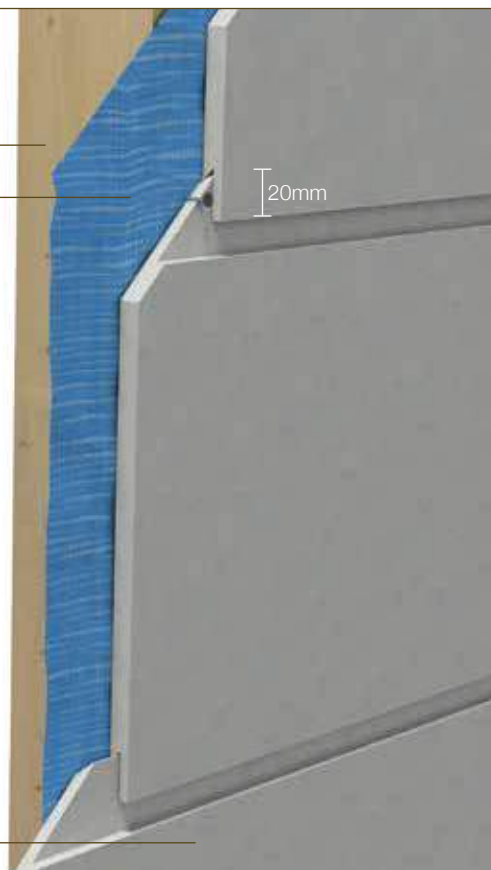

*Components not supplied by BGC

INSTALLATION DETAILS

FIGURE 10
STRATUM™ / STRATUM™ DUO / STRATUM™ TRIO BRAD FIXING TO TIMBER

Stud*

Vapour Permeable Sarking*

Suitable for N1, N2 and N3 Wind Zones.

Stratum™



FIGURE 11 STRATUM™ CONTOUR
CONCEALED FIXING

Stud*

Fastener*

Vapour Permeable Sarking*

Suitable for Wind Zones up to
N4/C2 on timber frame
N5/C3 on steel frame.

Stratum™ Contour

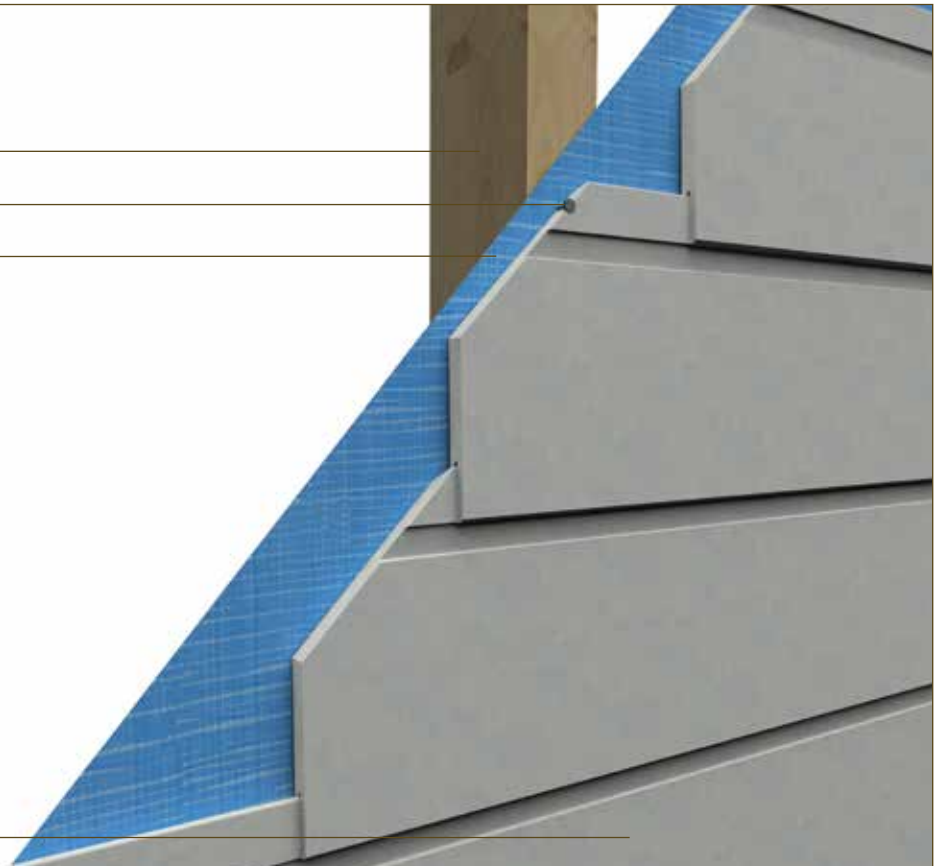

*Components not supplied by BGC

INSTALLATION DETAILS

FIGURE 12
EXTERNAL CORNER – MITRE

Vapour Permeable Sarking*
continuous around corner

Flashing*

Apply continuous bead of
sealant to corner flashing

Cut the ends of the boards to
a 45° angle. Prime ends and
join with sealant. Push tightly
together and wipe excess.

Install boards and nail to corner studs min
20mm back from end of board

20mm

FIGURE 13
EXTERNAL CORNER
ALUMINIUM TRIM

Vapour Permeable Sarking*
continuous around corner

Apply continuous bead of
sealant to external corner

Install boards leaving nominal 2mm gap to
aluminium corner and seal with sealant

BGC Aluminium External Corner

*Components not supplied by BGC

INSTALLATION DETAILS

FIGURE 14
EXTERNAL
CORNER
TIMBER STOP

Vapour Permeable Sarking*
continuous around corner

Flashing*

Apply continuous bead of
sealant to corner flashing

Cut boards to finish 2mm short of
timber stop. Seal gap with sealant

Install boards and nail to corner studs
minimum 20mm back from end of board

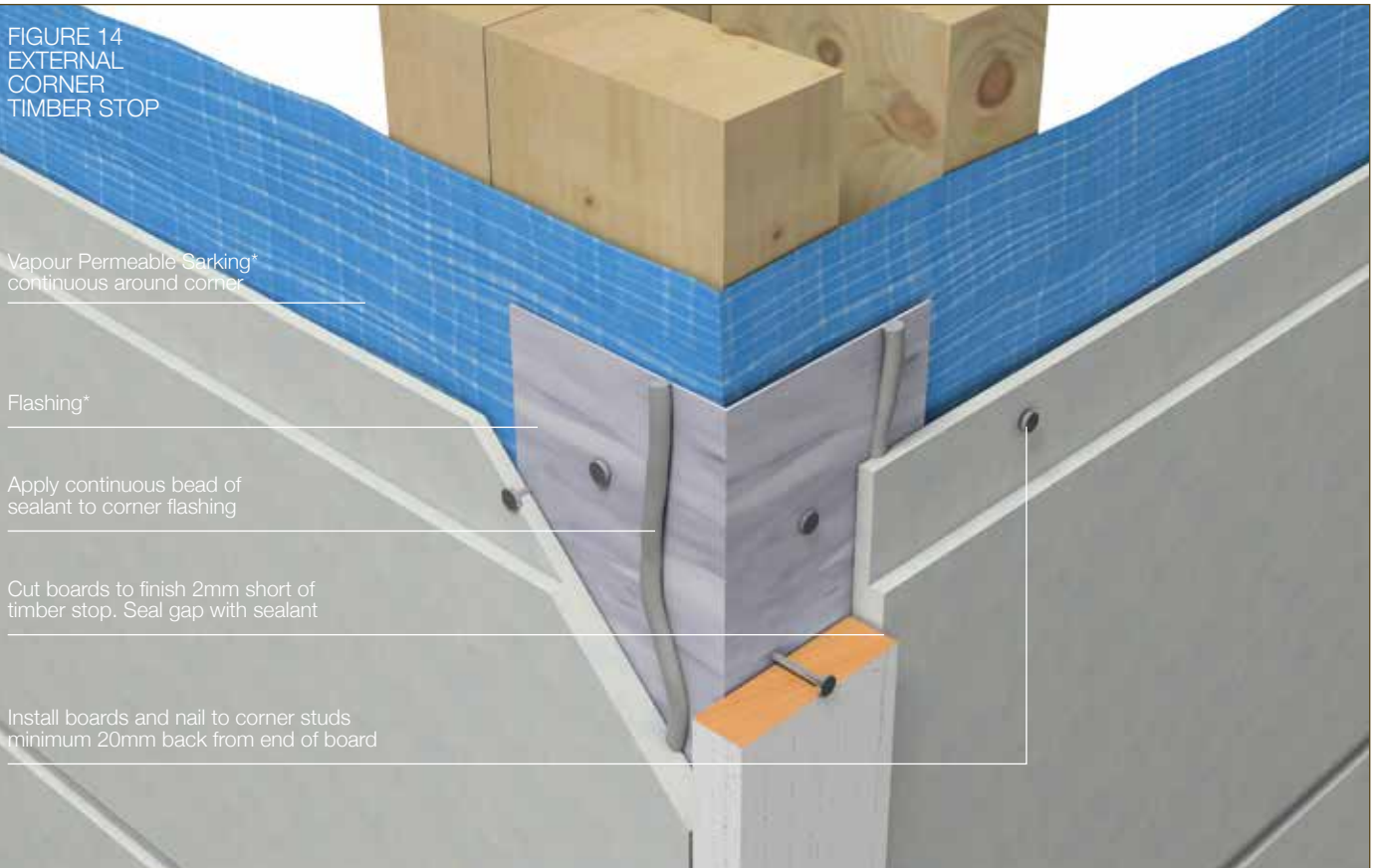

*Components not supplied by BGC

INSTALLATION DETAILS

FIGURE 15
INTERNAL CORNER – MITRE

Double Studs

Vapour Permeable Sarking*

Flashing*

Apply continuous bead of sealant to corner flashing

Stratum™

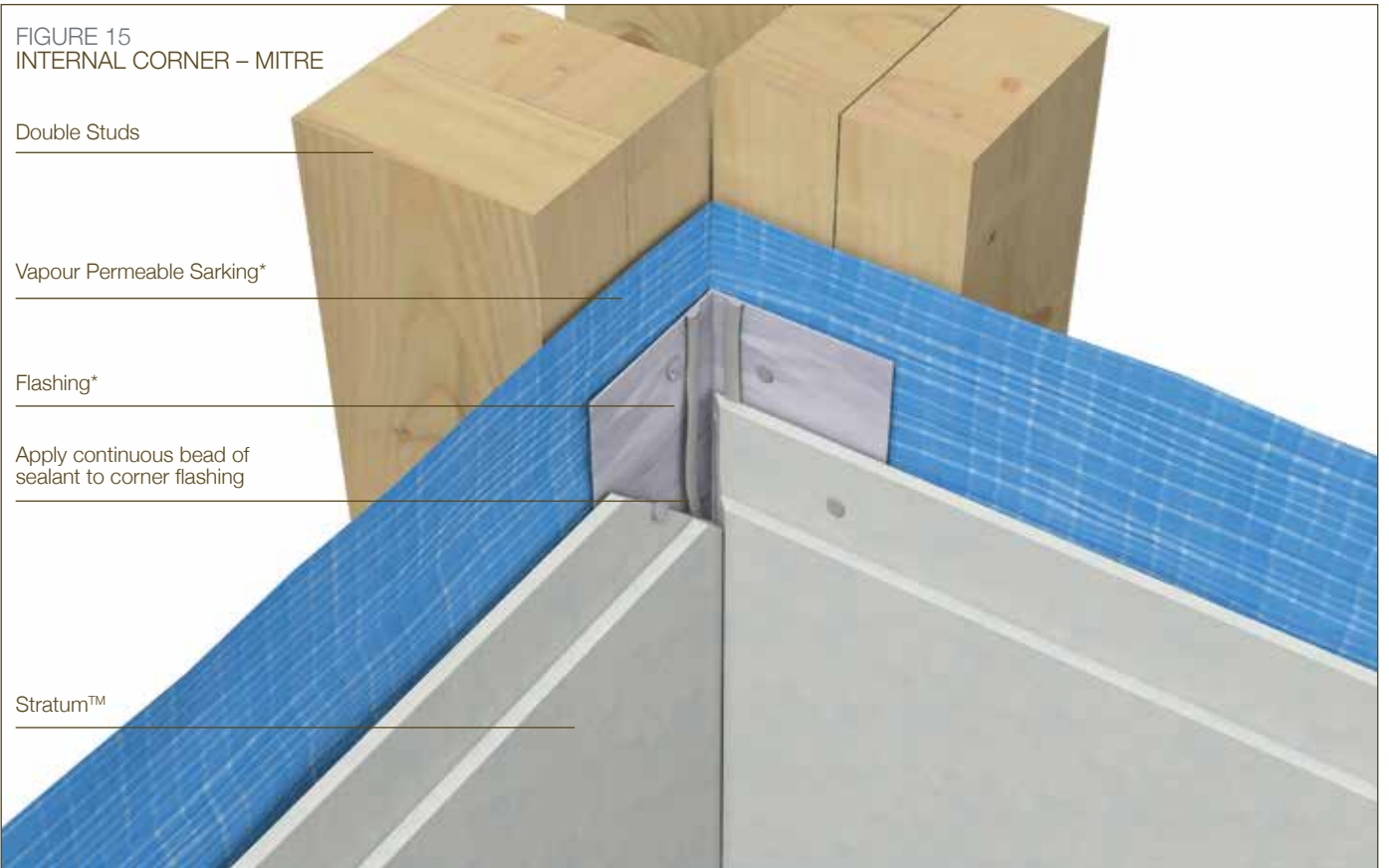

FIGURE 16
INTERNAL CORNER – ALUMINIUM TRIM

Double Studs*

Vapour Permeable Sarking*

BGC Aluminium External Corner

Apply continuous bead of sealant to aluminium corner

Install boards leaving nominal 2mm gap to aluminium corner

Stratum™

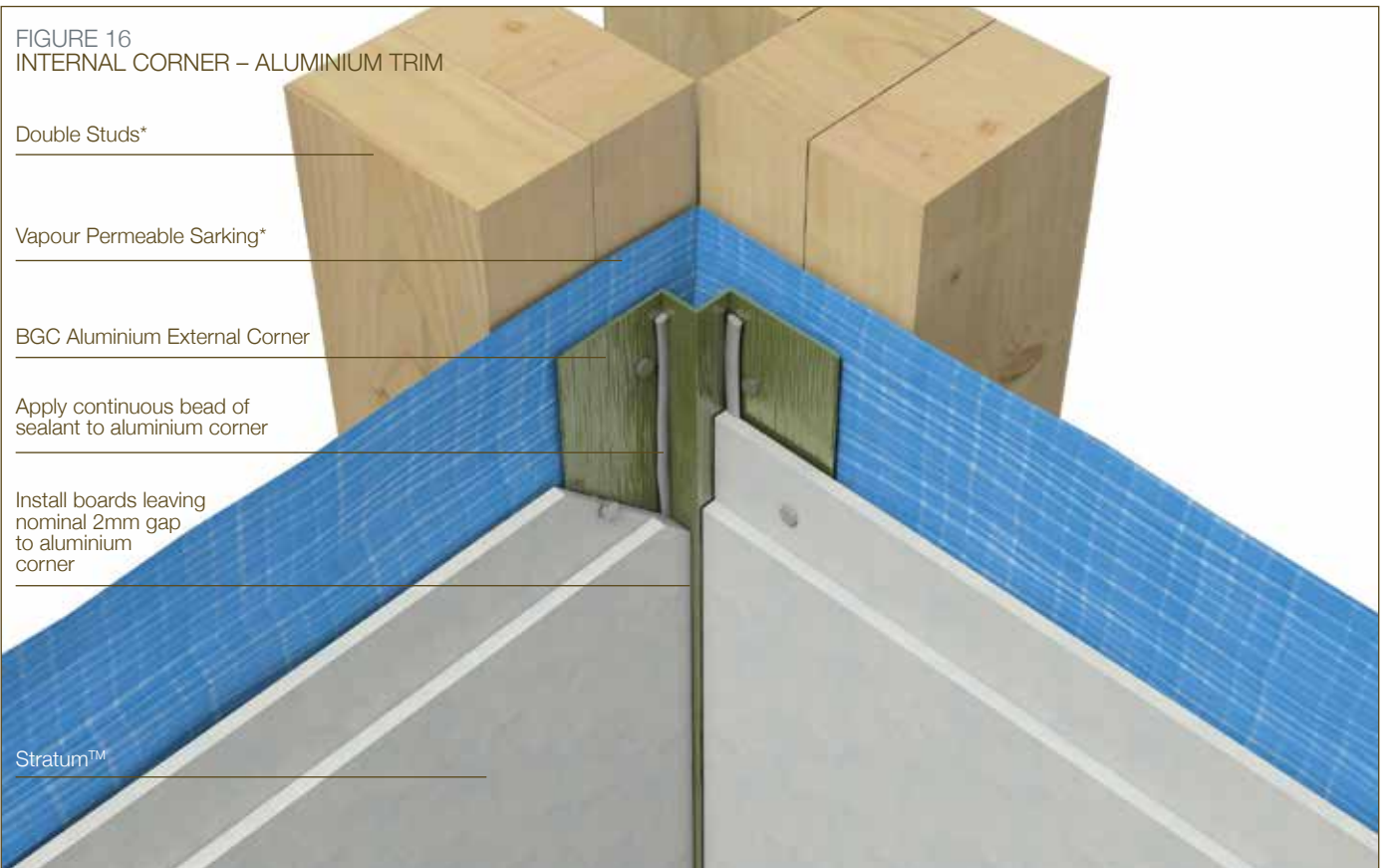

*Components not supplied by BGC

INSTALLATION DETAILS

FIGURE 17
WINDOW HEAD

Stratum™

Vapour Permeable Sarking*

Corrosion Resistant Flashing*

±6mm

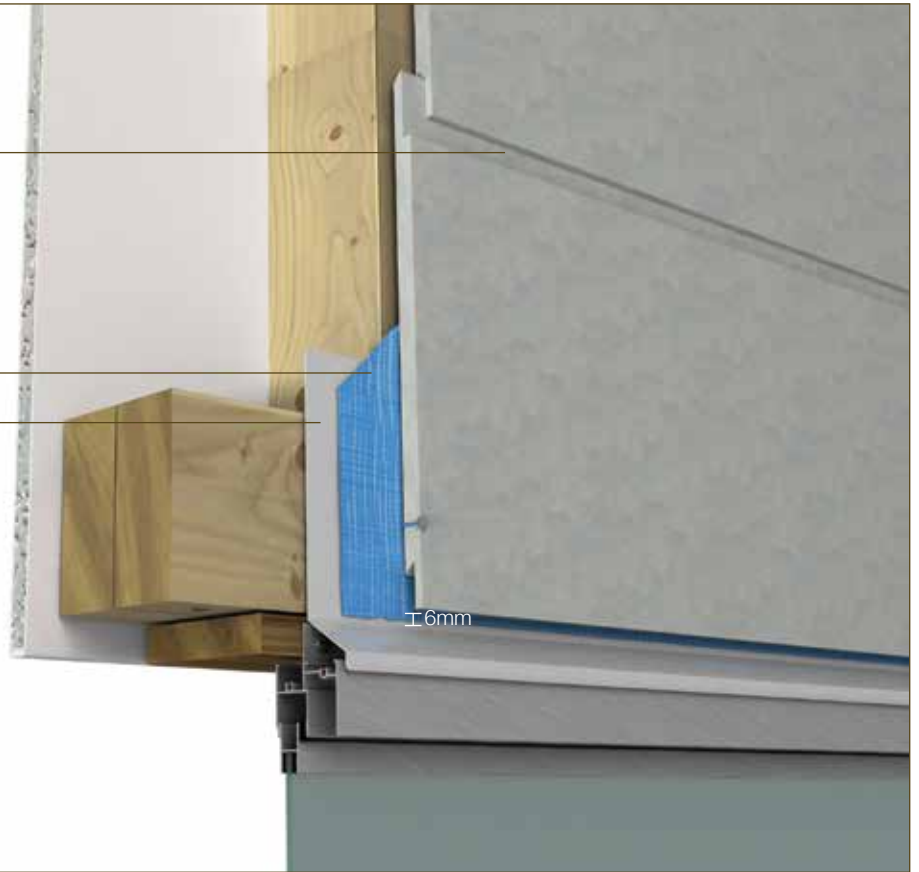

FIGURE 18
WINDOW SILL

Sealant

Window Flashing*

Flexible Sub-Sill Flashing*

Vapour Permeable Sarking*

Stratum™

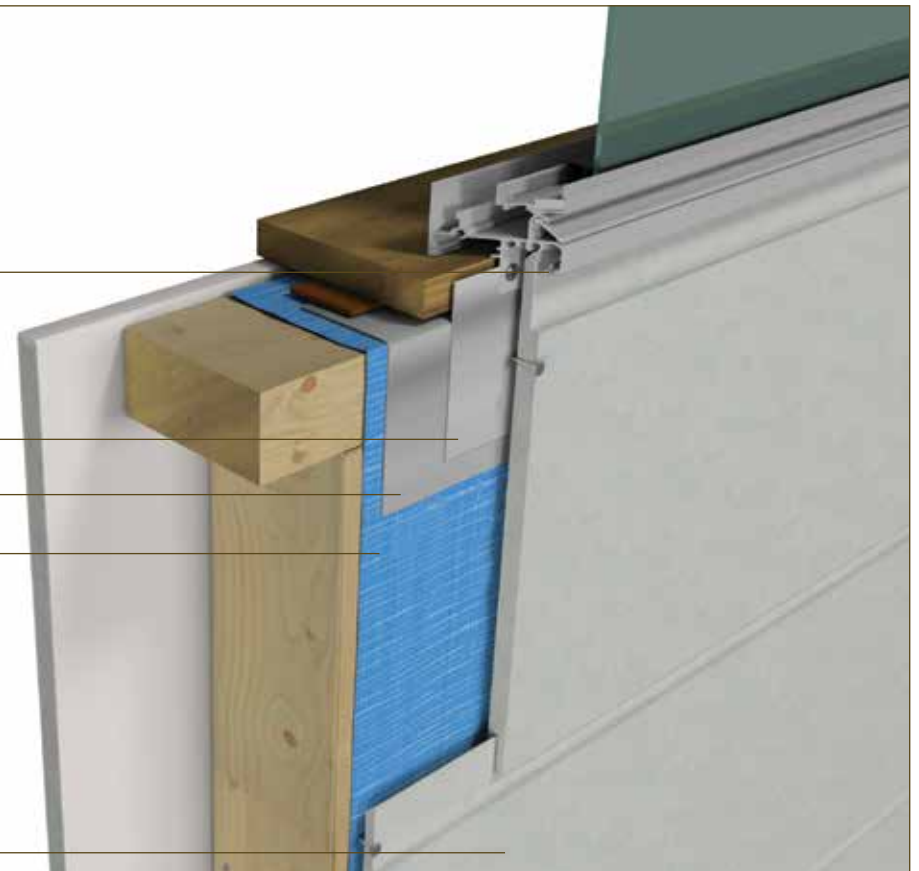

*Components not supplied by BGC

INSTALLATION DETAILS

FIGURE 19
WINDOW JAMB

Double Studs

Vapour Permeable Sarking*

Window Flashing*

Continuous bead of sealant

Stratum™



*Components not supplied by BGC

THERMAL BREAKS

Thermal breaks are required for steel framed buildings, in walls enclosing habitable and or usable spaces. Careful consideration of thermal heat transfer and the position of thermal breaks need to be addressed by the architects, engineers and building designers.

Balustrades, parapets, and other non-enclosing wall elements may not require thermal bridging, except where the possibility of high thermal heat transfer exists through the steel CFS sections to the main structural steel element of the building.

As part of the BGC Fibre Cement range EPDM Foam Gasket is able to act as a thermal break and is required to prevent moisture ingress at sheet joins. EPDM Foam Gasket can also be used as a Thermal Break Tape and provides an R value of R 0.2 in accordance with the Building Code of Australia.

The EPDM Foam Gasket should be placed on all frame contact faces and at noggins top and bottom plates.

NOTE // Thermal breaks (BGC EPDM Foam Gasket) is a self adhesive foam gasket/tape. It is installed over the building wrap (sarking).

Where the vertical gasket meets the horizontal gasket a gap of 3mm should be left to allow moisture to escape. Install BGC EPDM Foam Gasket continuously to all vertical framing first, then all horizontal framing (plates, noggins).

FIGURE 20
THERMAL BREAKS

Steel Frame*

EPDM Foam Gasket

Vapour Permeable Sarking*

Stratum™

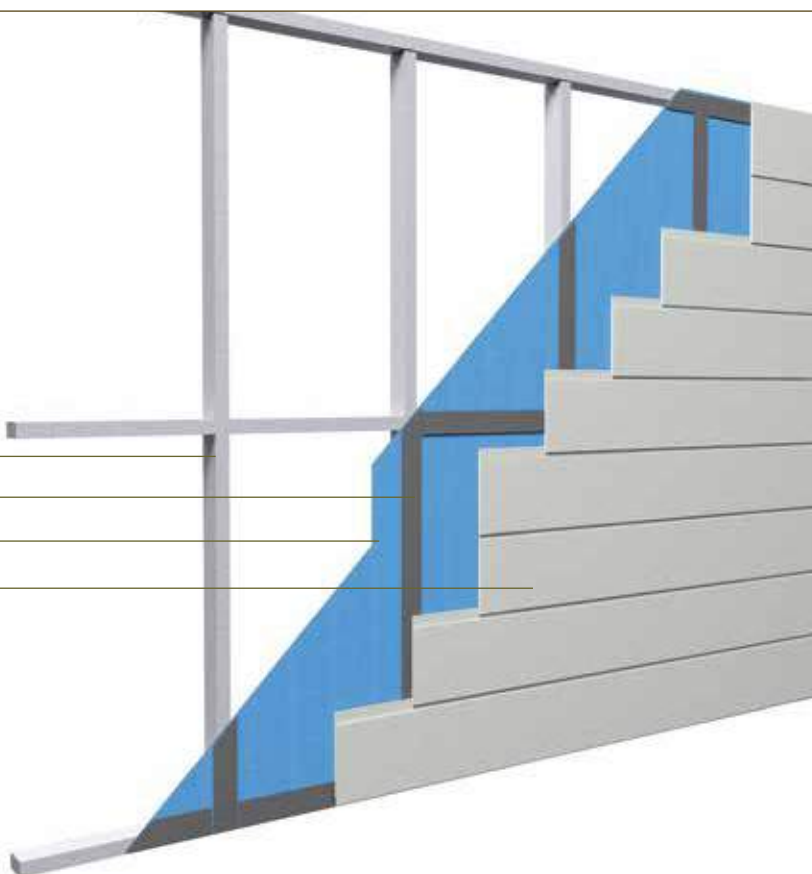

*Components not supplied by BGC

BUSHFIRE & BOUNDARY WALL AREAS

Stratum™ is eminently suited for both bushfire and boundary wall applications in residential and multi residential buildings.

Stratum™ may be used by itself to achieve up to and including BAL 40 when fixed direct to frame as per the fixing instructions in this manual.

Stratum™ when used in conjunction with GTEK™ Fire and Wet Area 16mm will comply with the requirements of AS3959:2009 and AS1530.4 to achieve BAL FZ>10 as well as 60 minute and 90 minute boundary wall systems.

BUSHFIRE AS3959:2009 APPLICATIONS

AS3959:2009 sets out a series of Bushfire threat levels to buildings described as BAL (Bushfire Attack Levels) as follows: BAL-Low, BAL-12.5, BAL-19, BAL-29, BAL-40 or BAL-FZ (Flamezone).

Stratum™ may be used to achieve a BAL-40 or BAL-FZ>10 when used in conjunction with GTEK™ Fire and Wet Area 16mm.

BOUNDARY/EXTERIOR WALLS

Stratum™ in conjunction with GTEK™ Fire and Wet Area 16mm can achieve both 60/60/60 and 90/90/90 FRL fire ratings from the outside as required by the BCA.

Where an exterior wall is required to achieve 60/60/60 FRL (Fire Resistance Level) from the outside, 1 layer of 16mm GTEK™ Fire and Wet Area 16mm installed with Stratum™ over the GTEK™ Fire and Wet Area 16mm will meet minimum BCA requirements.

Similarly 2 layers of GTEK™ Fire and Wet Area 16mm used in conjunction with Stratum™ will achieve 90/90/90 from the outside.

NOTE: All exterior walls must have sarking beneath the Stratum™. No adhesives are to be used when installing GTEK™ Fire and Wet Area 16mm and the Stratum™. Nails or screws must be used.

For more information please contact your nearest BGC Fibre Cement office.

FIGURE 21
BOUNDARY WALL SYSTEM

GTEK™ Wall 10mm
GTEK™ Fire and Wet Area 16mm
35x70 Pine Batten*
Vapour Permeable Sarking
Stratum™

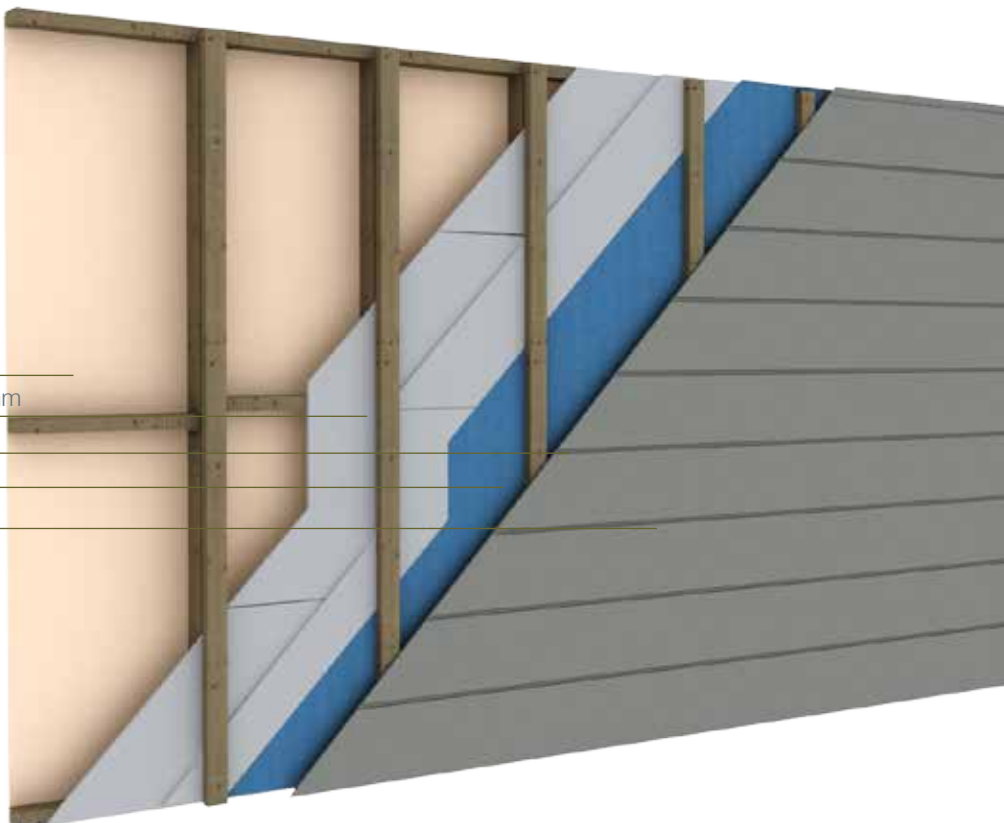

*Components not supplied by BGC

PAINTING

It is recommended that Stratum™ is painted according to the paint manufacturer's instructions within three months following delivery to site with a minimum of two coats of quality exterior paint. Apply chosen paint finish to the manufacturer's recommendations.

Should Stratum™ be exposed to the elements for a period beyond the initial three months to achieve an optimum finish an additional priming coat is recommended prior to the top finishing coats being applied.

Ensure that the Stratum™ planks are dry and clean prior to applying a quality exterior paint system.

MAINTENANCE

Stratum™ when used in accordance with this literature requires no direct maintenance.

To guard against water penetrating the structure and damaging the framework, annual inspections of the cladding system should be carried out. Check flashing, sealant joints and paint work. Flashing and sealants must continue to perform their design function.

Damaged planks should be replaced as originally installed. Paintwork should be maintained.

INSULATION

Stratum™ planks will require insulation to be installed in some regions that have thermal loss regulations.

Insulation should be installed in accordance with the manufacturer's instructions. Insulation batt's must fit snugly between framing members to minimise heat loss

FREEZE THAW

Stratum™ is subject to freeze / thaw conditions must be painted.

Stratum™ should not be used in situations where it will be in direct contact with snow or ice for prolonged periods

DEEMED TO COMPLY

For an up to date and complete list of BGC Products that are 'Deemed to Comply' please refer to www.ntlis.gov.au/deemedtocomply

WARRANTY

We warrant that our products are free from defects caused by faulty manufacture or materials for a period of 15 years from the date of purchase. If you acquire any defective products, we will repair or replace them, supply equivalent replacement products or refund the purchase price within 30 days of receiving a valid claim subject to product inspection and confirmation of the existence of a defect by BGC. We will bear the cost of any such repair, replacement or refund.

This warranty is given by:

BGC Fibre Cement Pty Ltd
121 Bannister Rd Canning Vale WA 6155
Phone 08 9334 4900 Fax 08 9334 4749

To claim under this warranty, you must provide proof of purchase as a consumer and make a written claim (including any costs of claiming) to us at the address specified above within 30 days after the defect was reasonably apparent, or if the defect was reasonably apparent prior to installation, the claim must be made prior to installation. You may not claim under this warranty for loss or damage caused by:

- faulty or incorrect installation by non-BGC installers (BGC's installation procedures are at www.bgcinnovadesign.com.au);
- failure to comply with the Building Code of Australia or any applicable legislation, regulations approvals and standards;
- products not made or supplied by BGC;
- abnormal use of the product; or
- normal wear and tear.

The benefits available under this warranty are in addition to other rights and remedies of the consumer under the law. Our goods come with guarantees that cannot be excluded under the Australian Consumer Law. You are entitled to a replacement or refund for a major failure and for compensation for any other reasonably foreseeable loss or damage.

You are also entitled to have the goods repaired or replaced if the goods fail to be of acceptable quality and the failure does not amount to a major failure.

CONTACT

TO CONTACT
YOUR NEAREST
BGC STOCKIST,
PLEASE CALL:

ADELAIDE
TELEPHONE
08 8250 4962

BRISBANE
TELEPHONE
07 3271 1711

MELBOURNE
TELEPHONE
03 9392 9444

PERTH
TELEPHONE
08 9334 4900

SYDNEY
TELEPHONE
02 9771 9660

NEW ZEALAND
TELEPHONE
0011 64 9273 1457

TECHNICAL HELP LINE
1300 652 242



Quality
ISO 9001
SAI GLOBAL

**BGC FIBRE CEMENT IS A
PROUD AUSTRALIAN OWNED
MANUFACTURER OF FIBRE
CEMENT PRODUCTS.**

**BGC FIBRE CEMENT PROVIDES
BUILDERS, DEVELOPERS AND
ARCHITECTS WITH A RANGE OF
DESIGN ALTERNATIVES AND
INNOVATIVE PRODUCTS,
SUCH AS:**

EXTERIOR PRODUCTS AND APPLICATIONS INNOVA RANGE OF PRODUCTS

DURACOM™ / A compressed fibre cement facade system.

DURAFLOOR™ / Is the ultimate flooring product that can be used in both interior and exterior applications.

DURAGRID™ RESIDENTIAL & DURAGRID™ LIGHT COMMERCIAL / A light weight facade giving a modern and durable finish.

DURAGROOVE™ / A vertically grooved exterior facade panel.

DURASCAPE™ / A lightweight exterior facade base sheet with a subtle vertical shadow line.

NULINE™ PLUS / A weatherboard style cladding system.

STONESHEET™ / Purpose designed substrate for stone tile facade.

STRATUM™ / Is a trio of plank products, each of which can be used as stand alone products or used together to create a striking exterior cladding solution.

STRATUM™ ERA / A traditional, yet contemporary as it is flat weatherboard.

EXTERIOR PRODUCTS AND APPLICATIONS BGC FIBRE CEMENT RANGE OF PRODUCTS

DURASHEET™ / Ideal for the cladding of gables and lining of eaves. Can also be used on commercial soffits and cladding on non impact areas.

DURAPLANK™ / Available in Smooth, Woodgrain and Rusticated finishes, Duraplank™ is ideal for exterior cladding of upper storey conversions or ground level extensions.

DURATEX™ / A base sheet used for textured coatings on exterior wall applications.

DURALINER™ PLUS / An exterior lining board, this is the perfect substrate for tiles and is ideal for wet areas.

DURALATTICE™ / Square or diamond patterned lattice, suitable for screens, pergolas and fences.

COMPRESSED / Used for domestic, commercial sheet for wet areas, flooring, partitions, exterior decking, fascia and facade cladding.

DURALUX™ PLUS / Suitable for exterior applications where it will be sheltered from direct weather.

INTERIOR PRODUCTS AND APPLICATIONS BGC FIBRE CEMENT RANGE OF PRODUCTS

DURALUX™ PLUS / An interior lining board suitable for ceilings and soffits.

DURALINER™ PLUS / An interior lining board, this is the perfect substrate for tiles and is ideal for wet areas.

CERAMIC TILE UNDERLAY / A substrate for ceramic and slate floor tiles.

VINYL CORK FLOOR COVERINGS / A substrate for vinyl floors.