

cowdroy

CATALOGUE

WEATHER SEALS | DOOR TRACK SYSTEMS | DOOR FURNITURE & ACCESSORIES | SHELVING | GLASS SYSTEMS | BARRIER DOORS



Cowdroy is a leading supplier of track and seal products across residential and commercial properties. With a large catalogue which includes door track systems, stops, guides and spare parts, door furniture, glazing tracks, shelving systems, Cowdroy provides products for a wide range of applications.

Independent design, research and development has always been a major focus for Cowdroy; the company has undergone numerous system and product upgrades to meet the increasingly varied needs of market changes and consumer demands.

With an emphasis on innovative design, research and development, Cowdroy has achieved the highest standard with its products and will continue to maintain that excellence.

HISTORY BUILDING BLOCKS

Established in 1890 initially as an advertising agency, Cowdroy has consistently been a pioneer in a number of industries, including producing the first illustrated advertisement in the Sydney Morning Herald and the world's first sliding glass door aluminium track system. The latter creation helped steer Cowdroy in a new direction towards the Australian hardware industry.

Since then, Cowdroy has been responsible for other major inventions such as the highly successful ball bearing sliding glass track, a sashless sliding window and a sliding door track system featuring ball bearings on a top race section, Concealed fixing wardrobe/cupboard track which was patented and sold under manufacturing license around the world.

Today, Cowdroy is owned by the Alchin Long Group, a family owned Australian company that specialises in the construction hardware industry and operates a number of brands, including Doric Products, Colonial Castings, Lock & Roll and Azuma Design. Cowdroy products can be found in Australia, New Zealand, Malaysia, across the rest of Asia Pacific and North America.



**INDEPENDENT
DESIGN, RESEARCH
& DEVELOPMENT
HAS ALWAYS BEEN A
MAJOR FOCUS**



RESIDENTIAL & COMMERCIAL APPLICATIONS



**MEET THE INCREASINGLY VARIED
NEEDS OF MARKET CHANGES &
CONSUMER DEMANDS**



NATIONAL CALL

Phone: 1 800 COWDROY (1800 269 376)
Email: sales@cowdroy.com.au

NEW SOUTH WALES

38 Redfern Street, Wetherill Park 2164
Phone: (02) 9604 3000
Fax: (02) 9604 8129
Sales Fax: (02) 9609 3694

QUEENSLAND

Unit 1, 90 Pritchard Road, Virginia 4014
Phone: (07) 3265 3311
Fax: (07) 3265 3733

TOWNSVILLE

Unit 1/42 Carmel Street, Garbutt, 4814
Phone: (07) 4779 5122
Fax: (07) 4725 5495

VICTORIA

Unit 1, 34-36 Deans Court, Dandenong Sth. 3175
Phone: (03) 9791 4062
Fax: (03) 9791 6759

SOUTH AUSTRALIA

Unit 2, 52 Wodonga Street, Beverley 5009
Phone: (02) 9604 3000
Fax: (02) 9604 8129

WESTERN AUSTRALIA

Unit 2, 2 Meares Way, Canning Vale 6155
Phone: (08) 9455 5354
Fax: (08) 9455 5461

CHRISTCHURCH, NEW ZEALAND

56 Treffers Road, Sockburn
Christchurch 8042
Email: sales@doricnz.co.nz
Phone: +64 (03) 943 2060
Fax: +64 (03) 943 2061

AUCKLAND, NEW ZEALAND

18 Kerwyn Ave, East Tamaki
Auckland 2013
Email: sales@doricnz.co.nz
Phone: +64 (09) 274 7279
Fax: +64 (09) 274 4453

STOCKING AGENTS**LAUNCESTON**

ACCESS HARDWARE Pty Ltd.
12 Goodman Court, Invermay 7248
Phone: (03) 6324 4900
Fax: (03) 6324 4901

MALAYSIA

Doric Products Pty Ltd.
No 7 Jalan Bulan U5 / 170
Bandar Pinggiran Subang, 40150 Shah Alam
Selangor, Malaysia
Email: sales@doric.com.my
Phone : +60 3 7845 5017
Fax: +60 3 7845 5014



NSW Head Office & Showroom

SECTION GUIDE

SECTION 1

- 6 WEATHER SEALS
- 11 Weather Seals selection guide
- 12 Re-order codes

SECTION 2

- 16 Door Track Selection guide
- 20 DOOR TRACK SYSTEMS
- 80 Product code index - Door Track Systems

SECTION 3

- 86 GLASS DOOR TRACK SYSTEMS
- 100 Product code index - Glass Door Track Systems

SECTION 4

- 102 REPLACEMENT COMPONENTS & ACCESSORIES
- 120 Product code index - Accessories

SECTION 5

- 124 SHELVING SYSTEMS
- 130 Product code index - Shelving Systems

SECTION 6

- 132 BARRIER DOORS
- 138 Product code index - Barrier Doors





CM5

EASY TO INSTALL
Single hinged
Inward opening
or sliding
Screen door

- Suits single hinged doors - Inward opening
- Automatically adjusts as you open & close your door

STAY WARMER IN WINTER
COOLER IN SUMMER

REDUCING ENERGY COSTS THROUGH IMPROVING EFFICIENCY

CM3

EASY TO INSTALL

- Suits single hinged doors - Inward opening
- Automatically adjusts as you open & close your door

STAY WARMER IN WINTER
COOLER IN SUMMER

REDUCING ENERGY COSTS THROUGH IMPROVING EFFICIENCY

CM2

EASY TO INSTALL

- Suits single & double hinged doors - Inward & outward opening
- Suitable for sliding doors & security screens
- Self adhesive backing

STAY WARMER IN WINTER
COOLER IN SUMMER

REDUCING ENERGY COSTS THROUGH IMPROVING EFFICIENCY

CM17

EASY TO INSTALL

- Suits single hinged doors - Inward opening
- Suitable for sliding doors security & screen doors

STAY WARMER IN WINTER
COOLER IN SUMMER

REDUCING ENERGY COSTS THROUGH IMPROVING EFFICIENCY

CM60

EASY TO INSTALL

- Suits single hinged doors - Inward opening
- Automatically adjusts as you open & close your door

STAY WARMER IN WINTER
COOLER IN SUMMER

AVAILABLE IN:
• Brown Australia
• Clear Australia
• Green Australia

cowdroy



1. WEATHER SEALS

DOOR

WINDOW & DOOR

GENERAL PURPOSE

GAP FILLERS

WEATHER SEALS SELECTION GUIDE

RE-ORDER CODES

ROLLING DOOR SEAL

CM1 - RETAIL PACK OF 1

- Suits single & double hinged doors - inward opening
- Seals gaps up to 19mm
- Seals against heat, cold, dust and draughts
- Especially suited to uneven and rough surfaces
- 915mm wide in grey



A furry door seal which hangs off hooks at the base of the door and rolls as the door is opened and closed.

BRUSH STRIP DOOR SEAL

CM2A - RETAIL PACK OF 1
CMT2A - TRADE PACK OF 12

- Suits single & double hinged doors - inward & outward opening
- Seals gaps up to 19mm
- Seals against heat, cold, dust, draughts and insects
- Self adhesive backing on Aluminium
- 915mm wide in bronze, clear & gold anodised, 1220mm wide in bronze & clear anodised - Trade Pack



An extruded aluminium door seal with a brush strip insert and a self adhesive backing tape. May also be screw fixed.

PVC BRUSH STRIP DOOR SEAL

CM2P - RETAIL PACK OF 1

- Suits single & double hinged doors - inward & outward opening
- Seals gaps up to 19mm
- Seals against heat, cold, dust, draughts and insects
- Self adhesive backing on PVC
- 915mm wide in black & white



A P.V.C. door seal with a brush strip insert and a self adhesive backing tape. May also be screw fixed.

AUTOMATIC CAM DOOR SEAL

CM3 - RETAIL PACK OF 1
CMT3 - TRADE PACK OF 12

- Suits single hinged doors - inward opening
- Seals gaps up to 16mm
- Seals against heat, cold, dust, draughts and insects
- Automatically lifts
- 915mm and 1220mm wide retail pack in bronze, clear & gold anodised



An extruded aluminium door seal with a rubber insert. Cam operation automatically lifts and drops the seal as required.

WEATHER PROOF DOOR SEAL

CM4 - RETAIL PACK OF 1
CMT4 - TRADE PACK OF 12

- Suits single & double hinged doors - inward & outward opening
- 25mm gap required between bottom of door and sill
- Seals against rain, heat, cold, dust, draughts, noise and insects
- 915mm & 1220mm wide in bronze, clear & gold anodised



An extruded 2-part aluminium door seal with rubber inserts. Seal fixes to the door while the tread plate fixes to the floor.

RUBBER STRIP DOOR SEAL

CM5 - RETAIL PACK OF 1
CMT5 - TRADE PACK OF 12

- Suits single & double hinged doors - inward & outward opening
- Also suitable for sliding security doors & sliding screen doors
- Seals gaps up to 19mm
- Seals against heat, cold, dust, draughts and insects
- 915mm wide in bronze, clear & gold anodised
- 1220mm wide in bronze & clear anodised - Trade Pack



An extruded aluminium door seal with a rubber insert. Screw fixes to the bottom of the door.

EXTRUDED PVC DOOR SEAL

CM17 - RETAIL PACK OF 1

- Suits single & double hinged doors - inward & outward opening
- Also suitable for sliding security doors & sliding screen doors
- Seals gaps up to 15mm
- Seals against heat, cold, dust, draughts and insects
- Self adhesive backing
- 915mm wide in brown, grey & white



An extruded P.V.C. door seal with a self adhesive backing tape. May also be screw fixed.

PERIMETER WEATHERSEAL & ACOUSTIC SEAL

CM7 - RETAIL PACK OF 1

- Self adhesive backing
- Pin hole fixing
- Can be cut to size
- 2 x 2100mm & 1 x 1220mm in white and brown



A co-extruded P.V.C. seal with self adhesive backing. Fixes to the door perimeter.

WEATHER PROOF DOOR SEAL

CM54 - RETAIL PACK OF 1

- Suits single & double hinged doors - inward opening
- 22mm to 25mm gap is required between bottom of door and sill
- Seals against rain, heat, cold, dust, draughts, insects and rodents
- 915mm wide in clear anodised



An extruded aluminium tread plate which fixes to the floor and extruded rubber seals which fix beneath the door.

AUTOMATIC DOOR SEAL

CM60 - RETAIL PACK OF 1

- Suits single & double hinged doors - inward opening
- Suits gaps up to 15mm
- Seals against heat, cold, dust, draughts, noise, insects and rodents
- Automatically lifts / drops when door is opened / closed
- 915mm wide in Bronze Anodised, Clear Anodised and Gold Anodised



An extruded aluminium door seal with rubber inserts. Pin trigger automatically lifts and drops the seal as required

WINDOW AND DOOR SEALS

FOAM WINDOW/DOOR SEAL

CM14 - RETAIL PACK OF 1

- Suits most windows & doors
- CM14 (9mm x 6mm)
- CM14A (19mm x 6mm) foam & CM14C (25mm x 6mm) seal gaps 3mm to 5mm
- CM14B (12mm x 12mm) foam seals gaps 8mm to 11mm
- Seals against heat, cold, dust, draughts, noise and insects
- 5m long in grey & white
- CM14B 2.5m long in grey & white



A continuous foam seal with a self adhesive backing tape. May be fitted to jambs, faces or edges of windows/doors.

RUBBER WINDOW/DOOR SEAL

CM48 - RETAIL PACK OF 1

- Suits most windows & doors
- Will seal gaps 3mm to 5mm
- Seals against rain, heat, cold, dust, draughts, noise, insects and rodents
- Self adhesive backing
- 5m long (2 x 2.5m) in brown, white & grey



A continuous rubber seal with a self adhesive backing tape. May be fitted to jambs, faces or edges of windows/doors.

RUBBER WINDOW/DOOR SEAL

CM59 - RETAIL PACK OF 1

- Suits most windows & doors
- Will seal gaps 2mm to 3mm
- Seals against rain, heat, cold, dust, draughts, noise, insects and rodents
- Self adhesive backing
- 5m long (2 x 2.5m) in brown, white & grey



A continuous rubber seal with a self adhesive backing tape. May be fitted to jambs, faces or edges of windows/doors.

BRUSH WINDOW/DOOR SEAL

CM61 - RETAIL PACK OF 1

- Suits most windows & doors
- Will seal gaps 3mm to 5mm
- Seals against rain, heat, cold, dust, draughts, noise, insects and rodents
- Self adhesive backing
- 5m long (6mm x 7mm) in grey

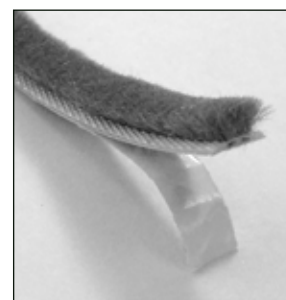

A continuous brush seal with a self adhesive backing tape. May be fitted to jambs, faces or edges of windows/doors.

General purpose seals are suitable for a wide range of user determined purposes.
A soft closed foam ideal for warehouse doors, sliding door, large windows, anti-rattle and vibration.

CLOSED P.V.C. FOAM

CM15 - RETAIL PACK OF 1

- Suits various applications
- Available 3m rolls in black
- CM15A (6 x 25mm) seals gaps up to 6mm
- CM15B (12 x 25mm) seals gaps up to 12mm
- CM15C (19 x 25mm) seals gaps up to 19mm
- Seals against rain, heat, cold, dust, draughts, noise, insects and rodents
- Self-adhesive backing



CLOSED MEDIUM P.V.C. FOAM SEAL

CM16 - RETAIL PACK OF 1

- Suits various applications
- Seals gaps up to 4.8mm
- Seals against rain, heat, cold, dust, draughts, noise, insects and rodents
- Self adhesive backing
- 10m roll (4.8x 25mm) in black



GENERAL PURPOSE SEALS

RUBBER SEAL

CM18 - RETAIL PACK OF 1

- Suits various applications
- Seals gaps up to 8mm
- Seals against dust, draughts, noise, insects and rodents
- Self adhesive backing
- 2m roll (8x 15mm) in black, white and grey



PURLIN TAPE

CM19 - RETAIL PACK OF 1

- Suits various applications
- Seals gaps up to 4mm
- Seals against noise
- Self adhesive backing
- 10m roll (4 x 25mm) in white



TYPICAL APPLICATIONS



GAP FILLERS

Gap filler will save you time and money on expensive sealants and caulks. A gap filler is polyethylene foam which is moisture resistant and easily manoeuvred around corners. It is safe to be used with silicone, oil base, polyurethanes, latex and acrylic chaulks and sealants.

GAP FILLER ROD

CM11A - RETAIL PACK OF 1

- Suitable for domestic & commercial applications
- Suits 3-4mm gaps
- Available in 5m rolls
- 6mm diameter



GAP FILLER ROD

CM11D - RETAIL PACK OF 1

- Suitable for domestic & commercial applications
- Suits 3-4mm gaps
- Available in 5m x 2 rolls
- 6mm diameter



GAP FILLER ROD

CM11B - RETAIL PACK OF 1

- Suitable for domestic & commercial applications
- Suits 6-7mm gaps
- Available in 5m rolls
- 10mm diameter



GAP FILLER ROD

CM11C - RETAIL PACK OF 1

- Suitable for domestic & commercial applications
- Suits 10-12mm gaps
- Available in 5m rolls
- 15mm diameter



WEATHER SEALS QUICK SELECTION GUIDE

| | SUITABLE FOR | | | | | PROTECTS AGAINST | | | | | | | |
|----------|--------------|--------------|--------------|----------------|-------------|------------------|------|----------|---------|-------|------|---------|------------------------|
| | Hinged Door | Bi-Fold Door | Sliding Door | Security Doors | All Windows | Heat / cold | Dust | Draughts | Insects | Noise | Rain | Rodents | |
| CM14/A/C | • | • | • | | • | • | • | • | | | | | Seals gaps 3mm - 5mm |
| CM14B | • | • | • | | • | • | • | • | | | | | Seals gaps 8mm - 11mm |
| CM15A | • | • | • | • | • | • | • | • | • | • | • | | Seals gaps up to 6mm |
| CM15B | • | • | • | • | • | • | • | • | • | • | • | | Seals gaps up to 12mm |
| CM15C | • | • | • | • | • | • | • | • | • | • | • | | Seals gaps up to 19mm |
| CM16 | • | • | • | • | • | • | • | • | • | • | • | | Seals gaps up to 4.8mm |
| CM18 | • | • | • | • | • | | • | • | • | | • | | Seals gaps up to 8mm |
| CM19 | • | • | • | • | • | | | | • | | | | Seals gaps up to 4mm |
| CM48 | • | • | • | | • | • | • | • | • | • | • | | Seals gaps 3mm - 5mm |
| CM59 | • | • | • | | • | • | • | • | • | • | • | | Seals gaps 2mm - 3mm |
| CM61 | • | • | • | • | • | • | • | | | | | | Seals gaps 3mm - 5mm |

| RETAIL REORDER CODES | | Size | Colour |
|----------------------|--|--------------|----------------|
| CM712BR | CM7 Weather & Acoustic Frame Seal | up to 2100mm | Brown |
| CM712WH | CM7 Weather & Acoustic Frame Seal | up to 2100mm | White |
| CM109GR | CM1 Rolling Door Seal Pack | 915mm | Grey |
| CM11AWH | CM11 Foam Gap Filler 6mm dia. | 5m | White |
| CM11BWH | CM11 Foam Gap Filler 10mm dia. | 5m | White |
| CM11CWH | CM11 Foam Gap Filler 15mm dia. | 5m | White |
| CM11DWH | CM11 Foam Gap Filler 6mm dia. | 10m | White |
| CM145GR | CM14 Foam Window/Door Seal Pack (9x6mm) | 5m | Grey |
| CM145WH | CM14 Foam Window/Door Seal Pack (9x6mm) | 5m | White |
| CM14AWH | CM14A Foam Window/Door Seal Pack (19x6mm) | 5m | White |
| CM14BWH | CM14B Foam Window/Door Seal Pack (12x12mm) | 2.5m | White |
| CM14CWH | CM14C Foam Window/Door Seal Pack (2x25mm) | 5m | White |
| CM14CGR | CM14C Foam Window/Door Seal Pack (2x25mm) | 5m | Grey |
| CM15A3BK | CM15A General Purpose Foam (6x25mm) | 3m | Black |
| CM15B3BK | CM15B General Purpose Foam (12x25mm) | 3m | Black |
| CM15C3BK | CM15C General Purpose Foam (19x25mm) | 3m | Black |
| CM1610BK | CM16 General Purpose Foam (4.8x25mm) | 10m | Black |
| CM179BR | CM17 Extruded PVC Door Seal Pack | 915mm | Brown |
| CM182BK | CM18 General Purpose Rubber 8mm | 2m | Black |
| CM182GR | CM18 General Purpose Rubber 8mm | 2m | Grey |
| CM182WH | CM18 General Purpose Rubber 8mm | 2m | White |
| CM2A9BZ | CM2A Brush Strip Door Seal Pack | 915mm | Bronze |
| CM2A9CL | CM2A Brush Strip Door Seal Pack | 915mm | Clear Anodised |
| CM2A9GO | CM2A Brush Strip Door Seal Pack | 915mm | Gold |
| CM2P09BK | CM2P PVC Brush Strip Door Seal Pack | 915mm | Black |
| CM2P09WH | CM2P PVC Brush Strip Door Seal Pack | 915mm | White |
| CM30309 | Replacement Rubber Seal | 915mm | - |
| CM39500 | Replacement Auto Cam Disc | - | - |
| CM309BZ | CM3 Automatic (Cam) Door Seal Pack | 915mm | Bronze |
| CM309CL | CM3 Automatic (Cam) Door Seal Pack | 915mm | Clear Anodised |
| CM309GO | CM3 Automatic (Cam) Door Seal Pack | 915mm | Gold |
| CM312BZ | CM3 Automatic (Cam) Door Seal Pack | 1220mm | Bronze |
| CM312CL | CM3 Automatic (Cam) Door Seal Pack | 1220mm | Clear Anodised |
| CM312GO | CM3 Automatic (Cam) Door Seal Pack | 1220mm | Gold |
| CM409BZ | CM4 Weather Proof Door Seal Pack | 915mm | Bronze |
| CM409CL | CM4 Weather Proof Door Seal Pack | 915mm | Clear Anodised |
| CM409GO | CM4 Weather Proof Door Seal Pack | 915mm | Gold |
| CM485BR | CM48 Rubber Window/Door Pack | 5m | Brown |
| CM485WH | CM48 Rubber Window/Door Pack | 5m | White |
| CM48GR | CM48 Rubber Window/Door Pack | 5m | Grey |
| CM509BZ | CM5 Rubber Strip Door Seal Pack | 915mm | Bronze |
| CM509CL | CM5 Rubber Strip Door Seal Pack | 915mm | Clear Anodised |
| CM509GO | CM5 Rubber Strip Door Seal Pack | 915mm | Gold |
| CM549CL | CM54 Weather Proof Door Seal Pack | 915mm | Clear Anodised |
| CM595BR | CM59 Rubber Window/Door Pack | 5m | Brown |
| CM595WH | CM59 Rubber Window/Door Pack | 5m | White |
| CM595GR | CM59 Rubber Window/Door Pack | 5m | Grey |
| CM609BZ | CM60 Automatic Door Seal Pack | 915mm | Bronze |
| CM609CL | CM60 Automatic Door Seal Pack | 915mm | Clear Anodised |
| CM609GO | CM60 Automatic Door Seal Pack | 915mm | Gold |
| CM615GR | CM61 Brush Window/Door Pack | 5m | Grey |

WEATHER SEALS - TRADE REORDER CODES

| TRADE REORDER CODES - PACK OF 12 (NOT FOR INDIVIDUAL SALE) | | Size | Colour |
|--|------------------------------------|--------|----------------|
| CMT2A9BZ | CM2A Brush Strip Door Seal Pack | 915mm | Bronze |
| CMT2A9CL | CM2A Brush Strip Door Seal Pack | 915mm | Clear Anodised |
| CMT2A9GO | CM2A Brush Strip Door Seal Pack | 915mm | Gold |
| CMT30309 | Replacement Rubber Seal | 915mm | Black |
| CMT39500 | Replacement Auto Cam Disc | - | Black |
| CMT309BZ | CM3 Automatic (Cam) Door Seal Pack | 915mm | Bronze |
| CMT309CL | CM3 Automatic (Cam) Door Seal Pack | 915mm | Clear Anodised |
| CMT309GO | CM3 Automatic (Cam) Door Seal Pack | 915mm | Gold |
| CMT312BZ | CM3 Automatic (Cam) Door Seal Pack | 1220mm | Bronze |
| CMT312CL | CM3 Automatic (Cam) Door Seal Pack | 1220mm | Clear Anodised |
| CMT312GO | CM3 Automatic (Cam) Door Seal Pack | 1220mm | Gold |
| CMT409BZ | CM4 Weather Proof Door Seal Pack | 915mm | Bronze |
| CMT409CL | CM4 Weather Proof Door Seal Pack | 915mm | Clear Anodised |
| CMT409GO | CM4 Weather Proof Door Seal Pack | 915mm | Gold |
| CMT485BR | CM48 Rubber Window/Door Pack | 5m | Brown |
| CMT485WH | CM48 Rubber Window/Door Pack | 5m | White |
| CMT48GR | CM48 Rubber Window/Door Pack | 5m | Grey |
| CMT509BZ | CM5 Rubber Strip Door Seal Pack | 915mm | Bronze |
| CMT509CL | CM5 Rubber Strip Door Seal Pack | 915mm | Clear Anodised |
| CMT509GO | CM5 Rubber Strip Door Seal Pack | 915mm | Gold |
| CMT549CL | CM54 Weather Proof Door Seal Pack | 915mm | Clear Anodised |





2. DOOR TRACK SYSTEMS

SLIDING DOORS - TOP HUNG

BI-FOLDING & FOLDING DOORS

DOUBLE & TRIPLE SLIDING WARDROBE & CUPBOARD DOORS

SLIDING CUPBOARD DOORS

SLIDING DOORS - BOTTOM ROLLING

SOFT-CLOSE ADAPTORS

The following points should help you select the appropriate door track system for your needs.

DOOR WEIGHT: _____ DOOR WIDTH / HEIGHT: _____

WALL OR TOP MOUNTED: _____ DOOR THICKNESS: _____

NUMBER OF DOORS: _____

DOOR TYPES: Sliding / Folding / Wardrobe / Cupboard / Cabinet

RETAIL SETS

| External door | Internal door | Glass door | Wardrobe doors | Cupboard doors | Glass Cabinet doors | Wall mounted track | Top mounted track | Floor fixed track | Top hung wheel | Bottom rolling wheel | Door side fix | End pivoting | Centre pivoting | Bottom guide | Top guide | End stop | Soft-close | Pelmet | System |
|---------------|---------------|------------|----------------|----------------|---------------------|--------------------|-------------------|-------------------|----------------|----------------------|---------------|--------------|-----------------|--------------|-----------|----------|------------|--------|------------------------------|
| ● | ● | | | | | ● | | | ● | | | | | ● | | ● | | ○ | ARROW |
| ● | ● | | | | | ● | | | ● | | | | | ● | | ● | | ○ | CENTURION (Heavy Duty Arrow) |
| ● | ● | | | | | ● | | | ● | | | | | ● | | ● | | ○ | QUAD BALL |
| ● | ● | | ● | ● | | ● | ● | | ● | | ○ | | | ● | | ● | | | FORERUNNER |
| ● | ● | | | | | ● | | | ● | | ○ | | | ● | | ● | | ● | FORERUNNER PELMET |
| ● | ● | | ● | ● | | ● | ● | | ● | | ○ | | | ● | | ● | ○ | ○ | TRIUMPH SLIDING |
| ● | ● | | ● | ● | | ○ | ● | | ● | | ● | | | ● | | ● | | | TROJAN |
| ● | ● | | ● | ● | | | ● | | | | | ● | | ○ | ● | | | | BARRACUDA BIFOLD |
| | | | ● | ● | | | ● | | ● | | | | | ● | | | | | QUICK-FIX |
| ● | ● | | ● | ● | | | ● | | ● | | ○ | ● | ● | ○ | | | | | TRIUMPH FOLDING |
| | | | ● | ● | | | | ● | | ● | | | | | ● | | ○ | | ROBEMAKER |
| | | | | ● | | | | ● | | ● | ● | | | | ● | | | | CABINETMAKER |
| | | | ● | ● | | | | ● | | | | | | | ● | | | | PLASTIC TRACK |
| ● | ● | ● | | | | ● | | | ● | | ● | | | ● | | ● | | | EXPOSED 90 |
| | | ● | | | | ○ | ● | | ● | | ● | | | ● | | ● | | | TROJAN (GLASS) |
| ● | ● | ○ | ● | ● | | ○ | ● | | ● | | ○ | | | ● | | ● | | | ALLWEATHER SLIDING |
| ● | | | | | | ● | | | ● | | ● | | | ● | | ● | | | GLIDEMASTER |

● Included Feature

○ Optional Extra

WILL YOUR TRACK BE WALL MOUNTED OR TOP MOUNTED?

Be aware of available fixing points/studs and any obstructions before committing to a fixing type.

IS YOUR DOORWAY A HIGH TRAFFIC AREA?

Upgrading to an enclosed track or a heavier system can greatly increase the operating life of your door track.

WANT TO KEEP THE NOISE TO A MINIMUM?

Enclosed aluminium tracks are far less noisy than open steel tracks and often run much more smoothly.

IS HUMIDITY OR DUST A CONCERN IN YOUR DOOR LOCATION?

Enclosed tracks offer a greater resistance to the build up of dirt and dust, thus increasing the operating life of your door track.

DO YOU SIMPLY WANT A TRACK THAT LOOKS GOOD?

Enclosed tracks are much more appealing and may be painted to suit decor, or you may prefer a pelmeted wall fix track.

| System Type | Max. Weight Door/Panel | Door/Panel width (mm) | Door Thickness (mm) min. | Track Length (mm) | Suits No. of doors | Track Type |
|---------------|------------------------|-----------------------|--------------------------|-------------------|--------------------|------------------------------------|
| Sliding | 35kg | Up to 915 | 25 | 1700 | 1 | Galvanised steel - open "J" |
| Sliding | 60kg | Up to 1220 | 30 | 1700-2310 | 1 | Galvanised steel - open "J" |
| Sliding | 50kg | Up to 920 | 25 | 1750 | 1 | Aluminium - open "J" mill finish |
| Sliding | 50kg | Up to 915 | 22 | 1830 | 1 | Aluminium - enclosed mill finish |
| Sliding | 50kg | Up to 1220 | 22-35 | 1850-2450 | 1 | Aluminium - enclosed white/mill |
| Sliding | 80kg | Up to 915 | 18 | 1830 | 1 | Aluminium - enclosed anodised |
| Sliding | 120kg | Up to 1500 | 28 | 3000 | 1 | Aluminium - enclosed mill finish |
| Bi-Folding | 13kg | Up to 450 | 19-35 | 915 | 2 panels | Aluminium - enclosed mill finish |
| Multi-Sliding | 25kg | Up to 950 | 19 | 2400 | 2 to 3 | Aluminium - double "J" mill finish |
| Multi-Folding | 25kg | Up to 450 | 25 | 1220-1830 | 2/4 panels | Aluminium - enclosed anodised |
| Multi-Sliding | 50kg | Up to 820 | 30-40 | 1620-3240 | 2 to 4 | Aluminium - white/anodised |
| Multi-Sliding | 20kg | Up to 650 | 15-18 | 1800 | 3 | Aluminium - white/anodised |
| Multi-Sliding | 6kg | Up to 950 | 5 | 1800 | 2 | Plastic - brown/white |
| Sliding | 90kg | Up to 1220 | 35 - 44 6-12 (glass) | 2450 | 1 | Steel - stainless/black |
| Sliding | 80kg | - | 8-12 | 4500-6000 | - | Aluminium - enclosed mill finish |
| Sliding | 240kg 100kg (glass) | 600-2500 | 30 - 100 6-10 (glass) | 6000 | - | Aluminium - enclosed anodised |
| Sliding | 272kg | 1500 | 38 | 5000-6500 | - | Aluminium - open "J" mill finish |

| External door | Internal door | Glass door | Wardrobe doors | Cupboard doors | Glass Cabinet doors | Wall mounted track | Top mounted track | Floor fixed track | Top hung wheel | Bottom rolling wheel | Door side fix | End pivoting | Centre pivoting | Bottom guide | Top guide | End stop | Soft-close | Pelmet | System |
|---------------|---------------|------------|----------------|----------------|---------------------|--------------------|-------------------|-------------------|----------------|----------------------|---------------|--------------|-----------------|--------------|-----------|----------|------------|--------|-----------------------------|
| ● | ● | | | | | ○ | ● | | ● | | | | | ● | | ● | | | INDUSTRO |
| | | | | ● | | | ● | | ● | | ● | ● | | | | | | | TRIUMPH STEALTH |
| | | | | ● | | | ● | | ● | | ● | ● | | ○ | | | | | OVERLAY CONCEALED BI-FOLD |
| ● | ● | | ● | ● | | | ● | | ● | | ○ | ● | ● | ○ | | | | | ALLWEATHER INTERNAL FOLDING |
| ● | ● | | ● | ● | | | ● | | ● | | | ● | | ○ | | | | | ALLWEATHER EXTERNAL FOLDING |
| | | | ● | ● | | | | ● | | ● | | | | | | ● | | ○ | ROBEMAKER TRIPLE |
| | | | ● | ● | | | ● | | ● | | ● | | | ● | | | | | MANHATTAN |
| | | | ● | ● | | | | ● | | ● | | | | | | | | | MIRROR ROBE |
| | ● | | | ● | | | ● | | ● | | | | | ● | | | | | TUDOR |
| | | | | ● | | | | ● | | ● | | | | | ● | | | | CUPBOARDLINE |
| | | | | ● | | | | ● | | ● | | | | | ● | | | | EASY ROLLER |
| | | | | ● | | | | ● | | ● | | | | | ● | | | | JIFFY ADJUSTER |
| ● | ● | | ● | ● | | | | ● | | ● | | | | | ● | | | | COASTLINE |
| | ● | | ● | ● | | | | ● | | ● | | | | | ● | | | | HORIZON |
| ● | ● | | ● | ● | | | | ● | | ● | | | | | ● | | | | TWIN-ROLL |
| ● | ● | | ● | ● | | | | ● | | ● | | | | | ● | | | | TIMBERLINE |
| ● | ● | | ● | ● | | | | ● | | ● | | | | | ● | | | | MAXI ROLLER |
| | | | | | ● | | | ● | | ● | | | | | ● | | | | BALL BEARING |
| | | | | | ● | | | ● | | ● | | | | | ● | | | | ROLLER BEARING 6 |
| | | | | | ● | | | ● | | ● | | | | | ● | | | | ROLLER BEARING 10 |
| | | | | | ● | | | ● | | ● | | | | | ● | | | | MKII SASHLESS WINDOW |

| System Type | Max. Weight Door/Panel | Door/Panel width (mm) | Door Thickness (mm) min. | Track Length (mm) | Suits No. of doors | Track Type |
|---------------|------------------------|-----------------------|----------------------------|-------------------|--------------------|------------------------------------|
| Sliding | 450kg | 2900 | 32 | 5800 | - | Galvanised steel - enclosed |
| Bi-Folding | 22kg | Up to 600 | 16-25 | 2000-5560 | 2 panels | Aluminium - enclosed white/mill |
| Bi-Folding | 25kg | Up to 500 | 16-25 | 3000 | 2 panels | Aluminium - open "J" white/mill |
| Multi-Folding | 90kg | 600-900 | 32 | 6000 | 8 panels | Aluminium - enclosed anodised |
| Multi-Folding | 90kg | Up to 900 | 35 | 6000 | 8 panels | Aluminium - enclosed anodised |
| Multi-Sliding | 50kg | Up to 820 | 30-40 | 2420 | 3 | Aluminium - white |
| Multi-Sliding | 45kg | - | 19-40 | 4880 | - | Aluminium - double "J" mill finish |
| Multi-Sliding | 50kg | - | 19 (timber) 4-6 (glass) | 5000 | - | Aluminium - white |
| Sliding | 20kg | - | 16 | 4500 | - | Aluminium - enclosed mill finish |
| Sliding | 20kg | - | 15 | 2500-5000 | - | Aluminium - anodised/mill finish |
| Sliding | 25kg | - | 12 | 2500-5000 | - | Aluminium - anodised/mill finish |
| Sliding | 28kg | - | 12 | 2500-5000 | - | Aluminium - anodised/mill finish |
| Sliding | 100kg | - | 29 | 2500-6000 | - | Brass/bronze - mill finish |
| Sliding | 120kg | - | 29 | 2500-6000 | - | Aluminium/brass/bronze - mill |
| Sliding | 200kg | - | 29 | 2500-6000 | - | Brass/bronze - mill finish |
| Sliding | 200kg | - | 35 | 2500-6000 | - | Brass/bronze - mill finish |
| Sliding | 227kg | - | 29 | 2500-6000 | - | Brass/bronze - mill finish |
| Multi-Sliding | 22kg | - | 6-6.38 | 4500 | - | Aluminium - anodised/mill |
| Multi-Sliding | 60kg | - | 6-6.38 | 4500 | - | Aluminium - anodised/mill |
| Multi-Sliding | 200kg | - | 10-10.38 | 4500 | - | Aluminium - anodised |
| Multi-Sliding | 52kg | - | 6-6.38 | 4500 | - | Aluminium - anodised |

SLIDING DOOR TRACK SYSTEM

APPLICATION



An entry level top-hung or wall mount track system designed for single internal doors. The open "J" track design allows for quick and easy installation.

FEATURES

- Rust resistant galvanised steel track
- Nylon tyred wheel with sealed ZZ ball bearings for smooth operation
- Anti-lift bracket and height adjustment slot
- Nylon door guide - slimline & unobtrusive
- Anti-bounce door stop
- Optional aluminium pelmet with ribbed face white

DETAILS

TECHNICAL SPECIFICATIONS

| | |
|-------------------------|--------------|
| Suits: | Single doors |
| Max. Door Width: | 915mm wide |
| Door Thickness: | 25mm min |

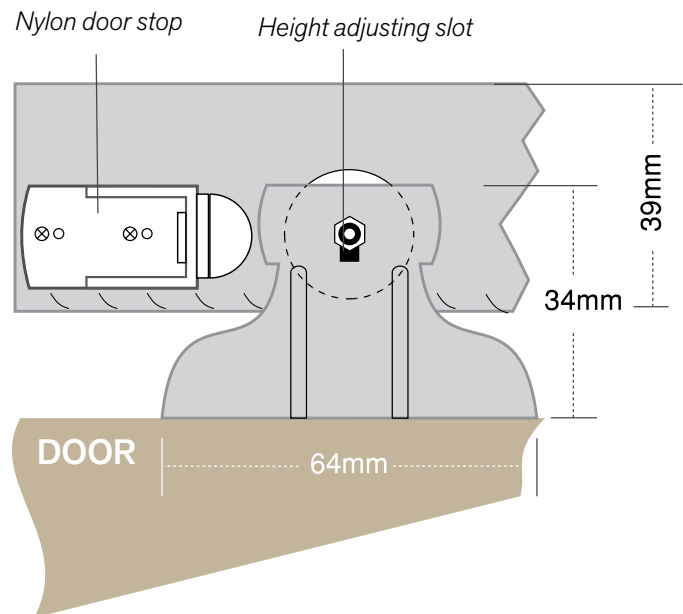
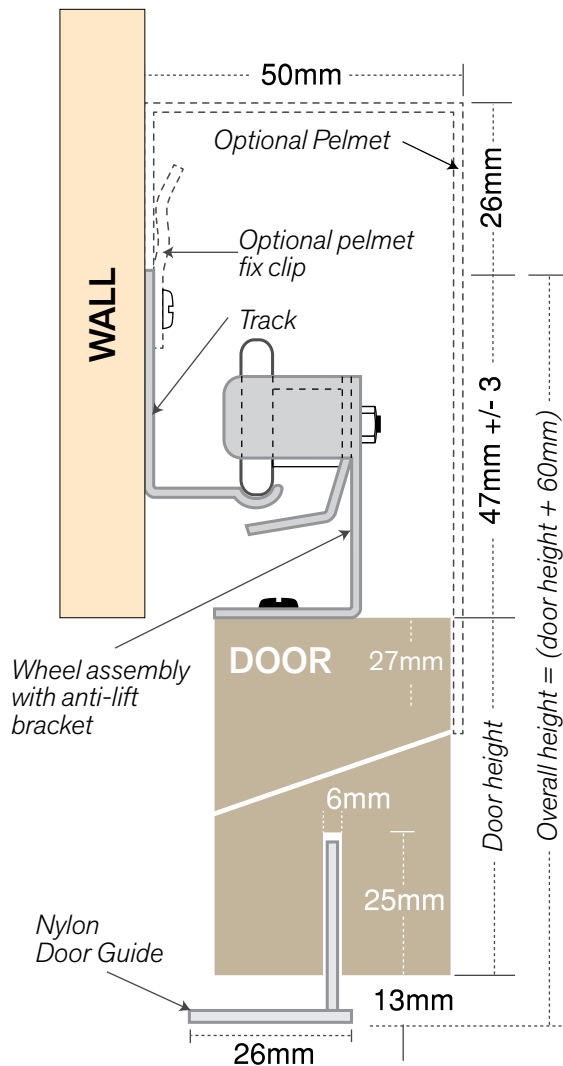

* Full product codes & options refer to **page 80**

COMPONENTS

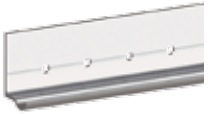

Galvanised steel track



Wheel assembly



Anti-bounce
door stop



Nylon door guide



Optional
aluminium pelmet

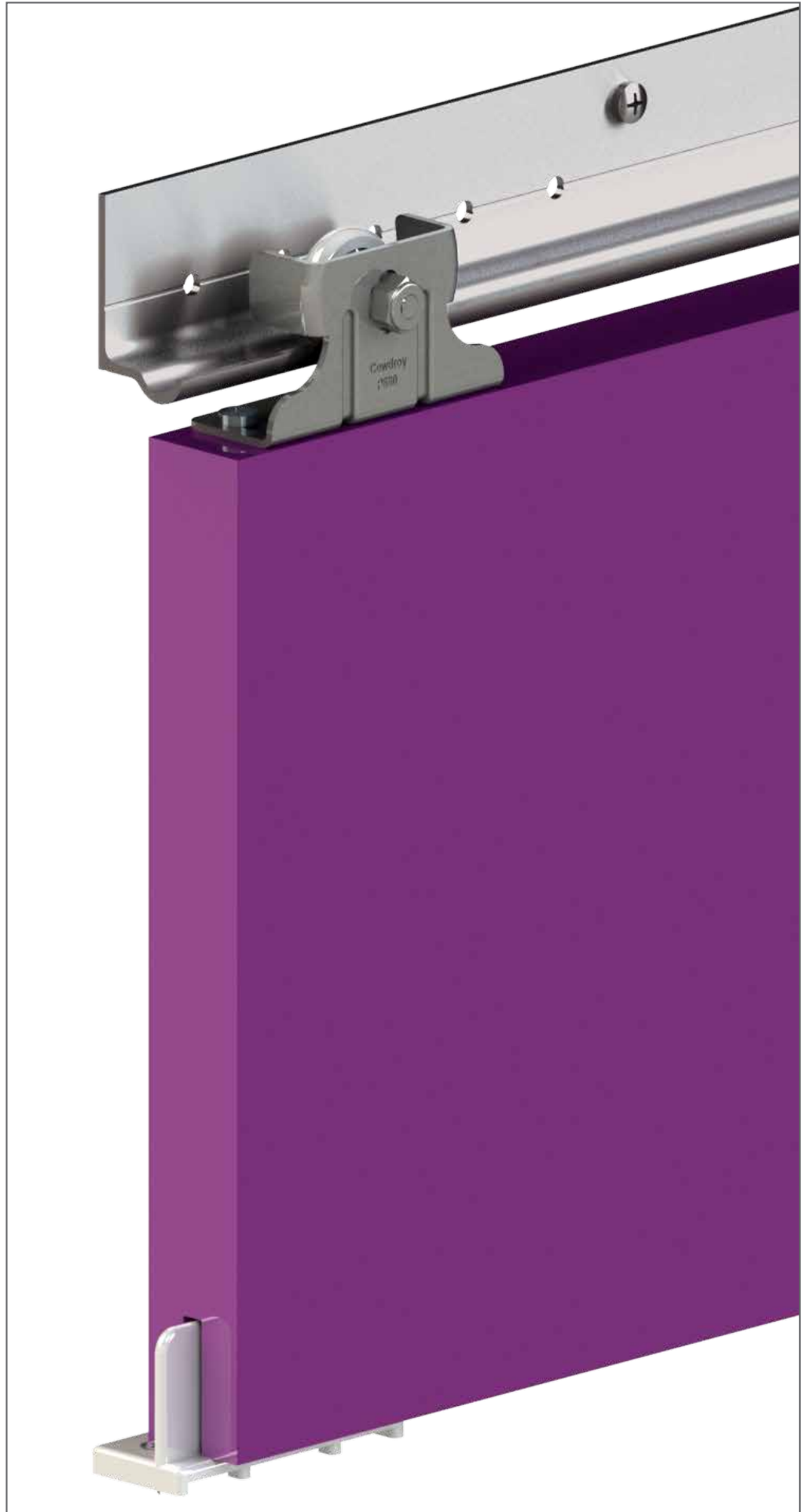

SLIDING DOOR TRACK SYSTEM

APPLICATION



An entry level top-hung system designed for single internal doors on or in a wall mount application. The open "J" track design and ratchet adjustment mechanism allows for easy installation.

FEATURES

- Galvanised steel track
- Nylon tyred wheel with sealed ZZ bearings for smooth operation.
- Anti-lift bracket with ratchet height adjustment mechanism
- Nylon door guide - slimline & unobtrusive
- Anti-bounce nylon door stop
- Optional aluminium pelmet with ribbed face

DETAILS

TECHNICAL SPECIFICATIONS

| | |
|-------------------------|--------------|
| Suits: | Single doors |
| Max. Door Width: | 1220mm wide |
| Door Thickness: | 30mm min |

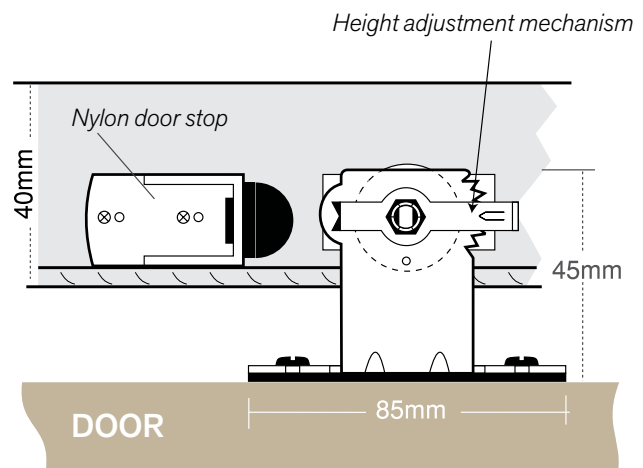
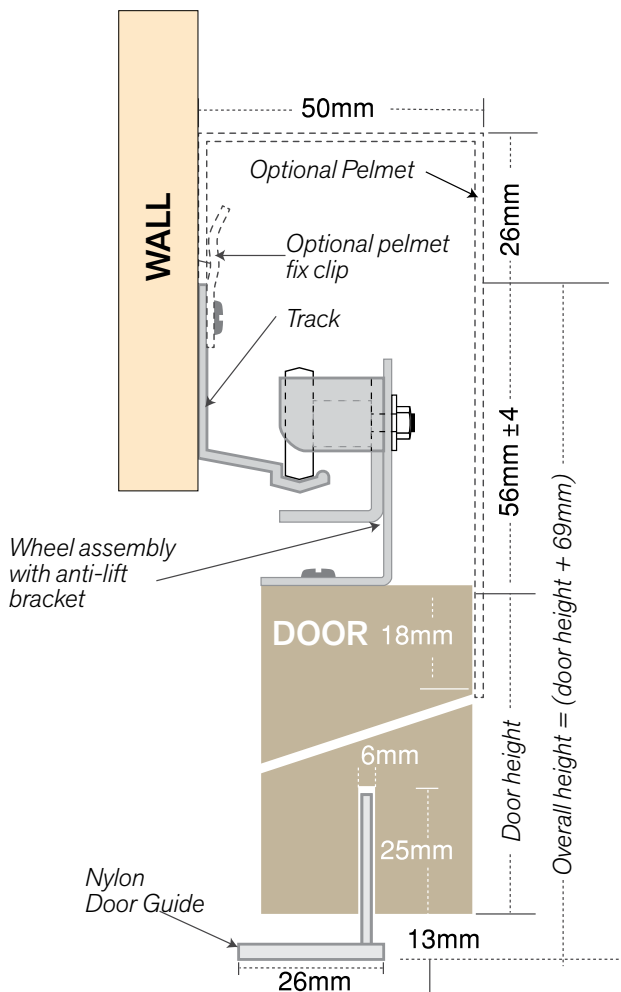

* Full product codes & options refer to **page 80**

COMPONENTS



Galvanised steel track



Wheel assembly



Anti-bounce
door stop



Nylon door guide



Optional
aluminium pelmet



SLIDING DOOR TRACK SYSTEM

APPLICATION



A smooth and quiet top-hung system designed for single internal doors in wall-mount applications. Ideal for bedrooms and ensuites.

FEATURES

- Aluminium track and door carrier
- Four balls clipped into two ball carriages
- Smooth & quiet - ideal for bedrooms
- Extensive height adjustment
- Nylon door guide - slimline & unobtrusive
- Anti-bounce door stop
- Optional aluminium pelmet with ribbed face

DETAILS

TECHNICAL SPECIFICATIONS

| | |
|-------------------------|--------------|
| Suits: | Single doors |
| Max. Door Width: | 920mm wide |
| Door Thickness: | 25mm min |

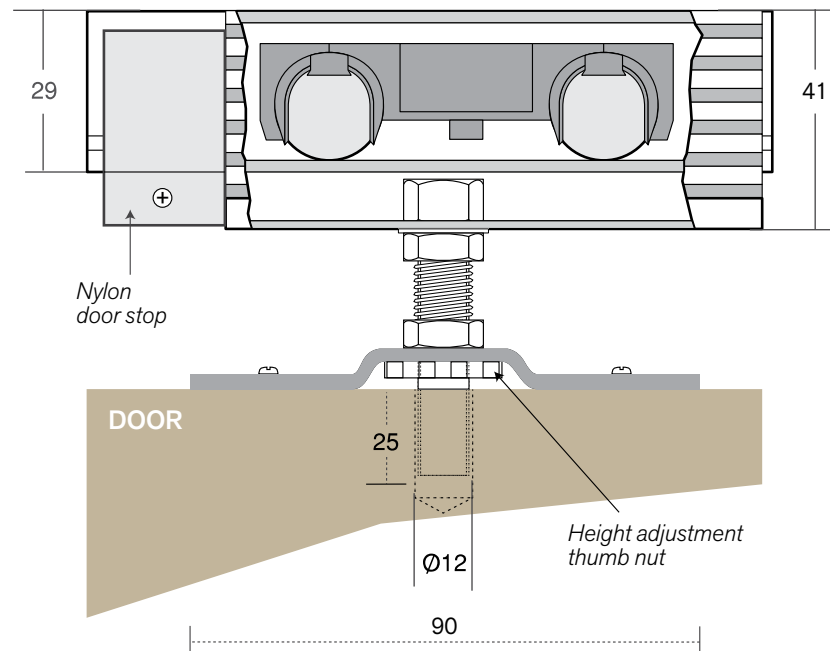
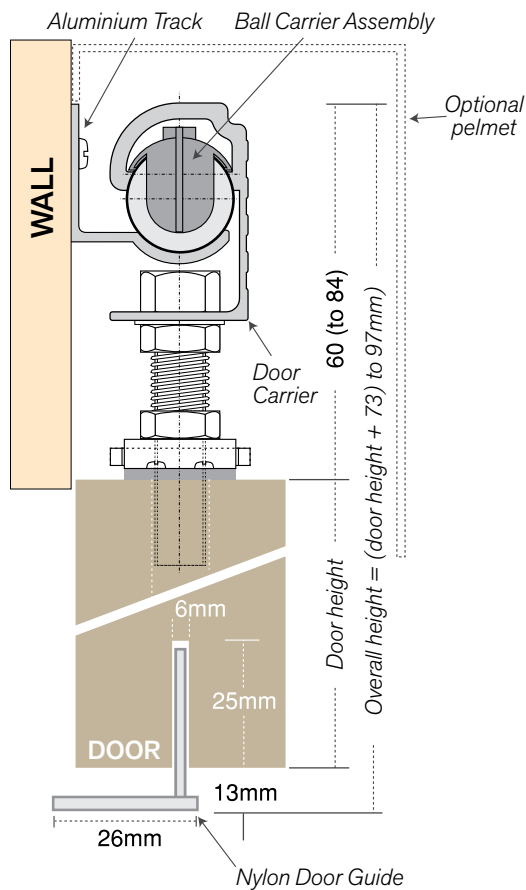

* Full product codes & options refer to **page 80**

COMPONENTS

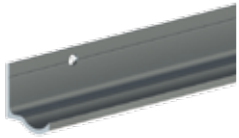

Aluminium track

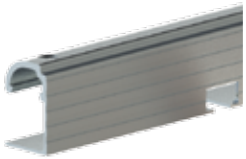

Aluminium door carrier



Carrier bracket



Ball carrier assembly



Nylon door stop



Nylon door guide



Optional
aluminium pelmet

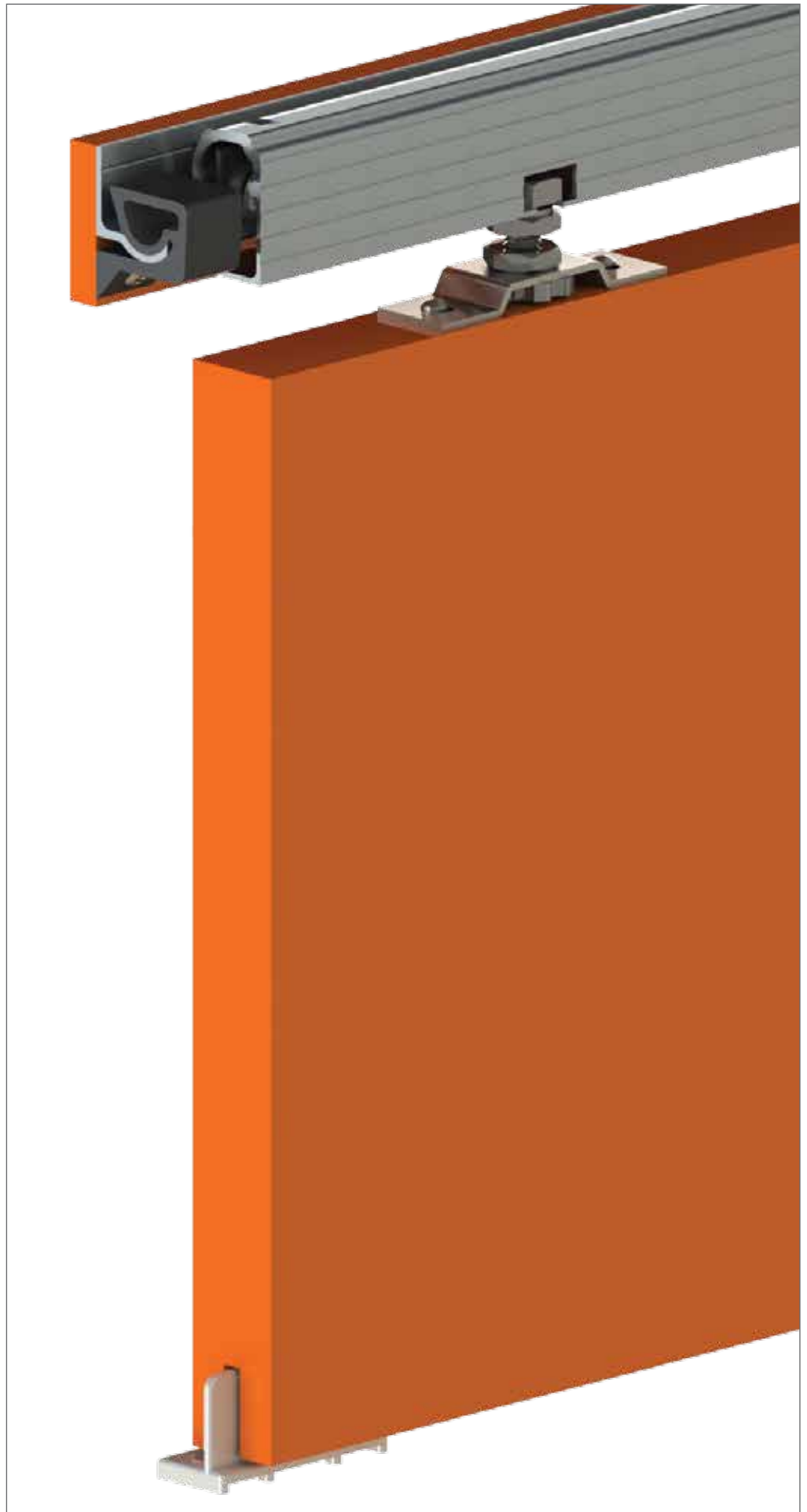

SLIDING DOOR TRACK SYSTEM

APPLICATION



The Forerunner Door Track system is an internal sliding door system suitable for doors up to a maximum of 50kg. Available to suit doors up to 915mm with options for top mount & wall mount track.

FEATURES

- 6mm height adjustment slot in wall mount track
- Nylon tyred wheels with ZZ bearings
- 2mm door thickness adjustment slot in wheel brackets
- Easily adjustable anti-bounce door stop
- Anti-bounce door stop
- Nylon door guide - slimline & unobtrusive
- Available in both top and wall mount options

DETAILS

TECHNICAL SPECIFICATIONS

| | |
|-------------------------|--------------|
| Suits: | Single doors |
| Max. Door Width: | 915mm wide |
| Door Thickness: | 22mm |

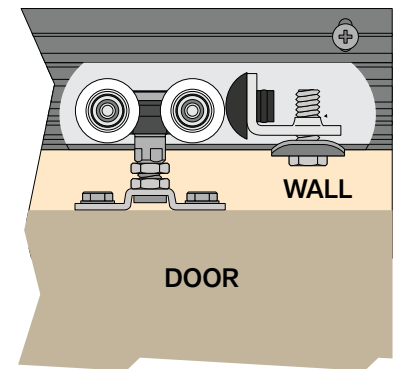
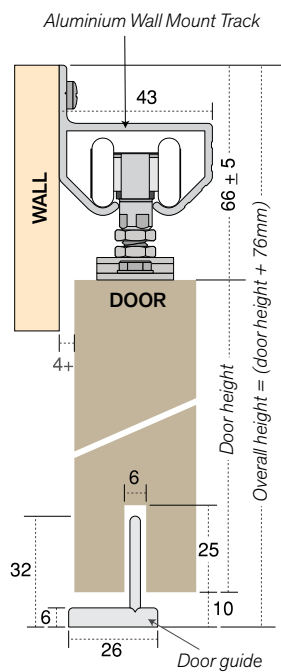
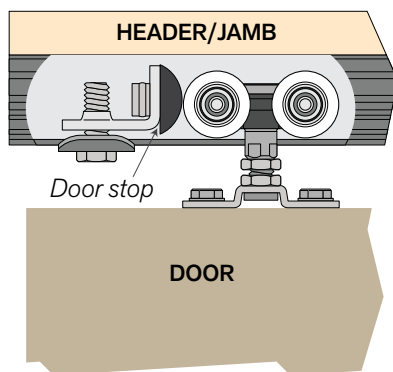
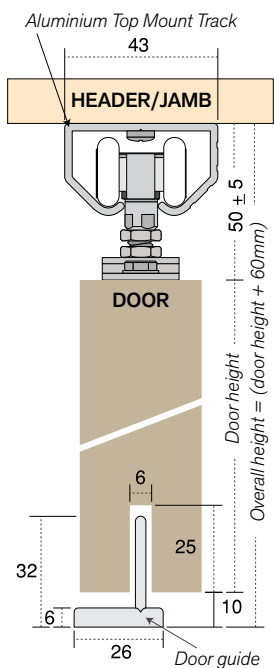

Door thickness 22 to 35mm

* Full product codes & options refer to **page 80**

COMPONENTS

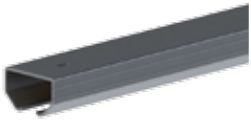

Aluminium top mount track



Aluminium wall mount track



Wheel assembly



Anti-bounce door stop



Nylon door guide

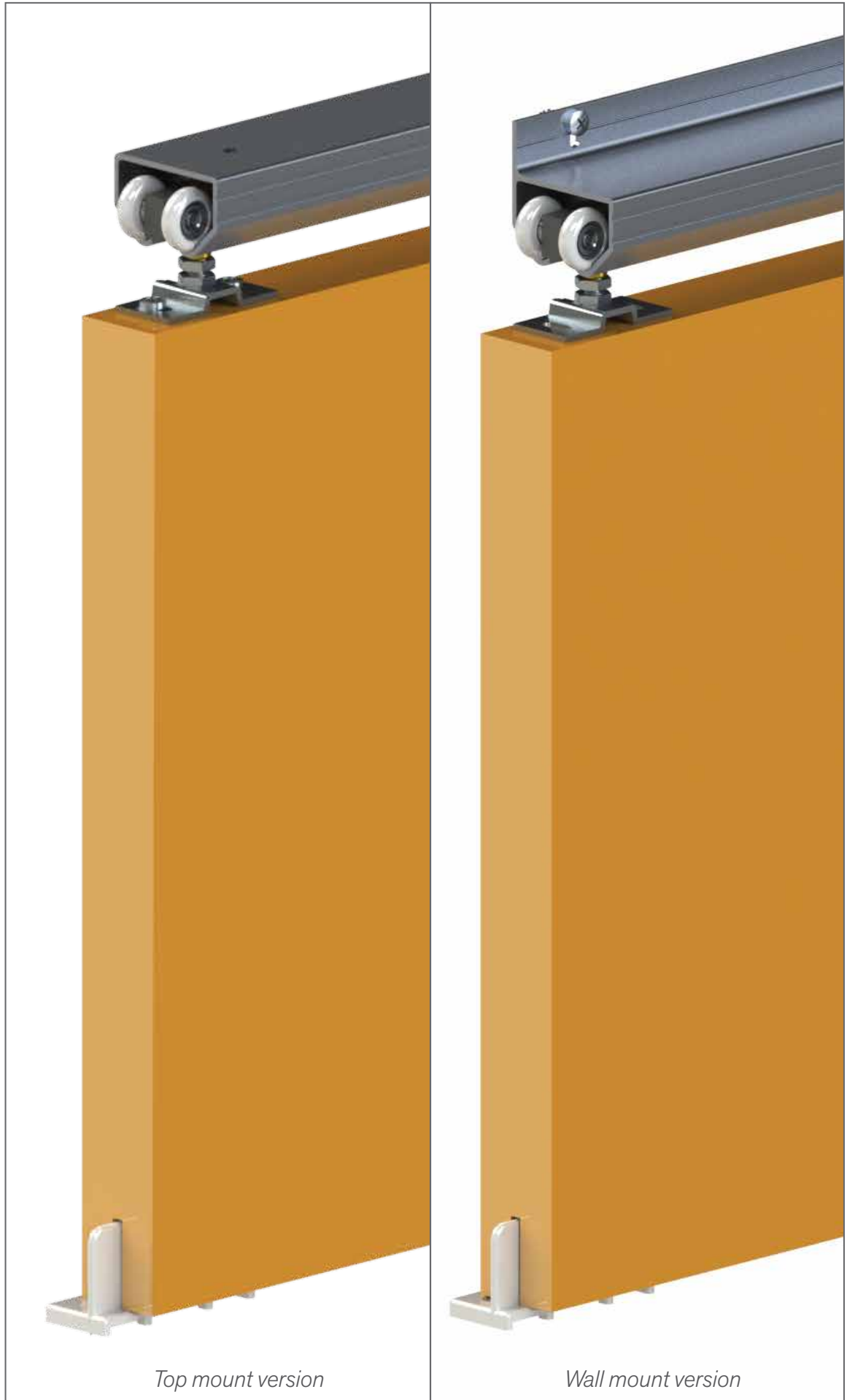

Top mount version

Wall mount version

SLIDING DOOR TRACK SYSTEM

APPLICATION



The Forerunner Pelmet Door Track system is an internal sliding door system suitable for doors up to a maximum of 50kg. Available to suit doors up to 915mm and 1220mm and with options of Mill Finish and Powdercoat White.

FEATURES

- Aluminium wall mount track with built-in pelmet
- 6mm height adjustment slot in track
- Nylon tyred wheels with ZZ bearings
- 2mm door thickness adjustment slot in wheel brackets
- Easily adjustable anti-bounce door stop
- Nylon end caps push easily into ends of track
- Nylon door guide - slimline & unobtrusive

DETAILS

TECHNICAL SPECIFICATIONS

| | |
|-------------------------|--------------|
| Suits: | Single doors |
| Max. Door Width: | 1220mm wide |
| Door Thickness: | 22-35mm |

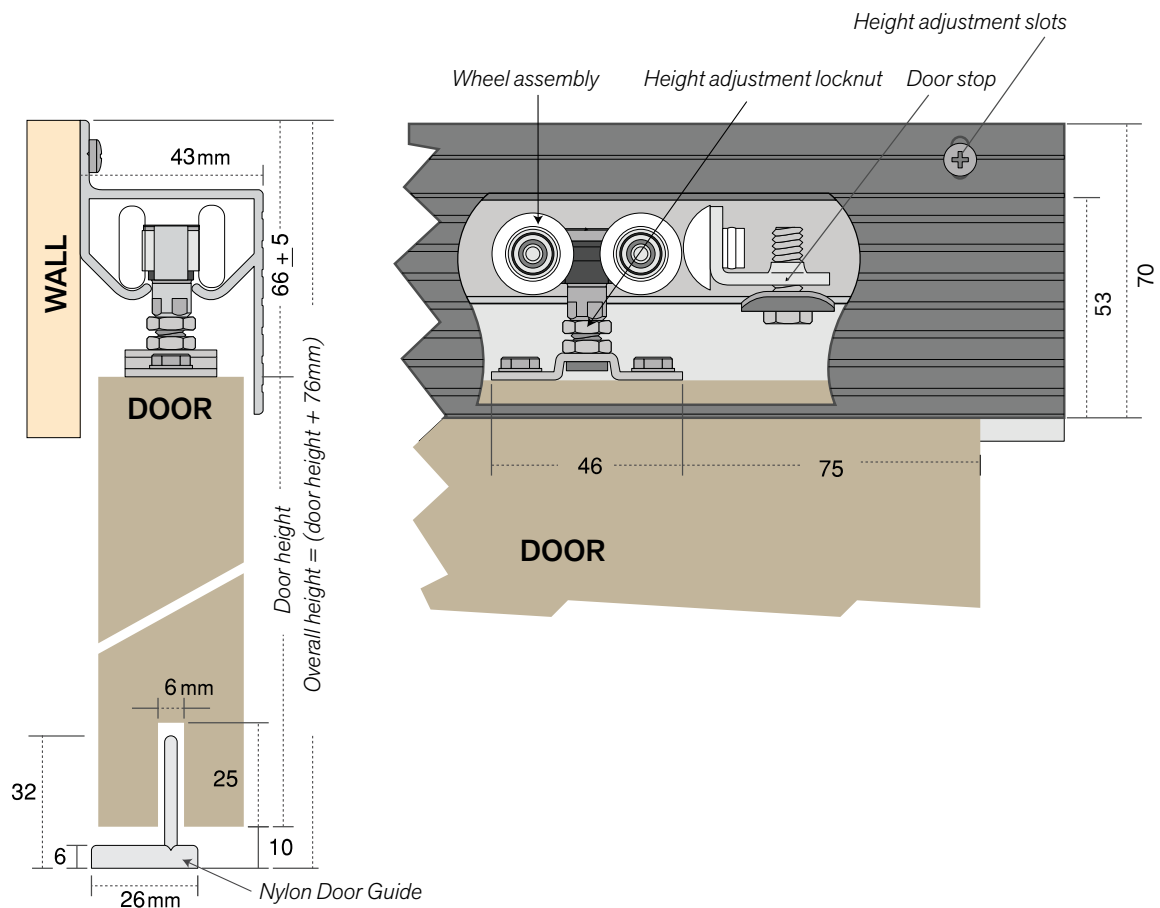

Door thickness 22 to 35mm

* Full product codes & options refer to **page 80**

COMPONENTS



Aluminium wall mount pelmet track



Wheel assembly



Anti-bounce door stop



Nylon door guide



Nylon end cap



SLIDING DOOR TRACK SYSTEM

APPLICATION



This is a high quality sliding door track system. This slimline track system is available in both top mount and wall mount options. It also has an 80kg rating, making it an ideal, all-round product.

FEATURES

- Wrap around track in clear anodised
- Option of wall mount or top mount track
- Nylon tyred, ball bearing 4 wheel carriages
- Nylon door guide - slimline & unobtrusive
- Anti-bounce end stop
- Optional aluminium pelmet with ribbed face - 1830mm & 3660mm white
- Quick release wheel assemblies

DETAILS

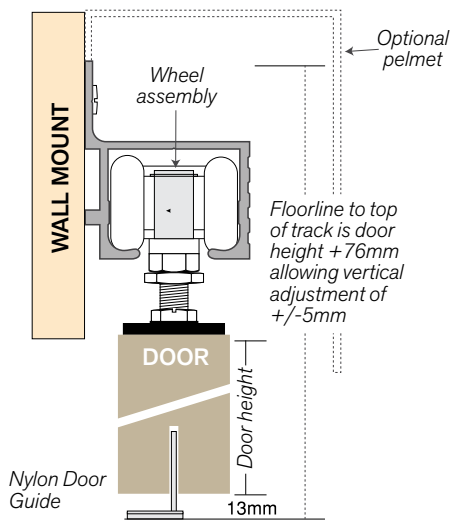

TECHNICAL SPECIFICATIONS

| | |
|-------------------------|--------------|
| Suits: | Single doors |
| Max. Door Width: | 915mm wide |
| Door Thickness: | 18mm min |

ADD A SOFT-CLOSE KIT TO YOUR SYSTEM

Soft-Close options available on page 78

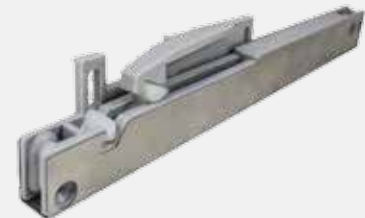

Soft-close adaptors are designed to slow the closing action of cabinet doors reducing noise and wear.

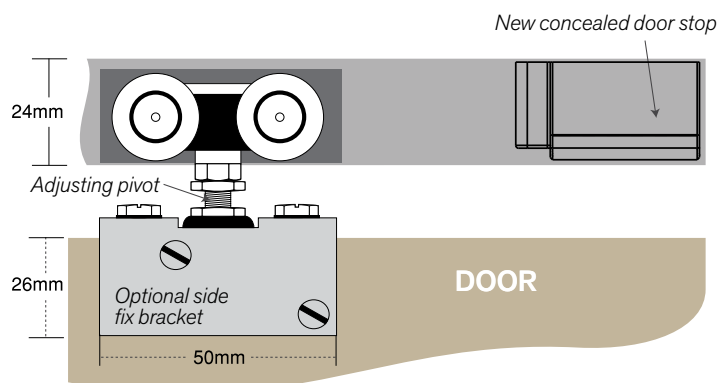
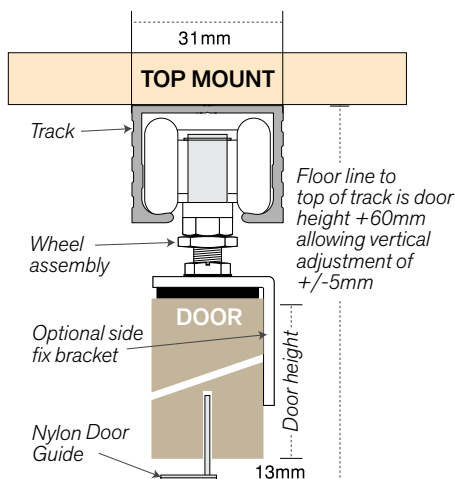

* Full product codes & options refer to **page 80**

COMPONENTS

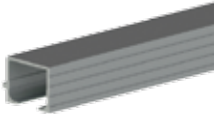

Top mount track



Wall mount track



Quick-release wheel assembly



Door side fix bracket



Nylon door stop



Nylon door guide



Nylon end cap



Soft-close
(Optional extra)

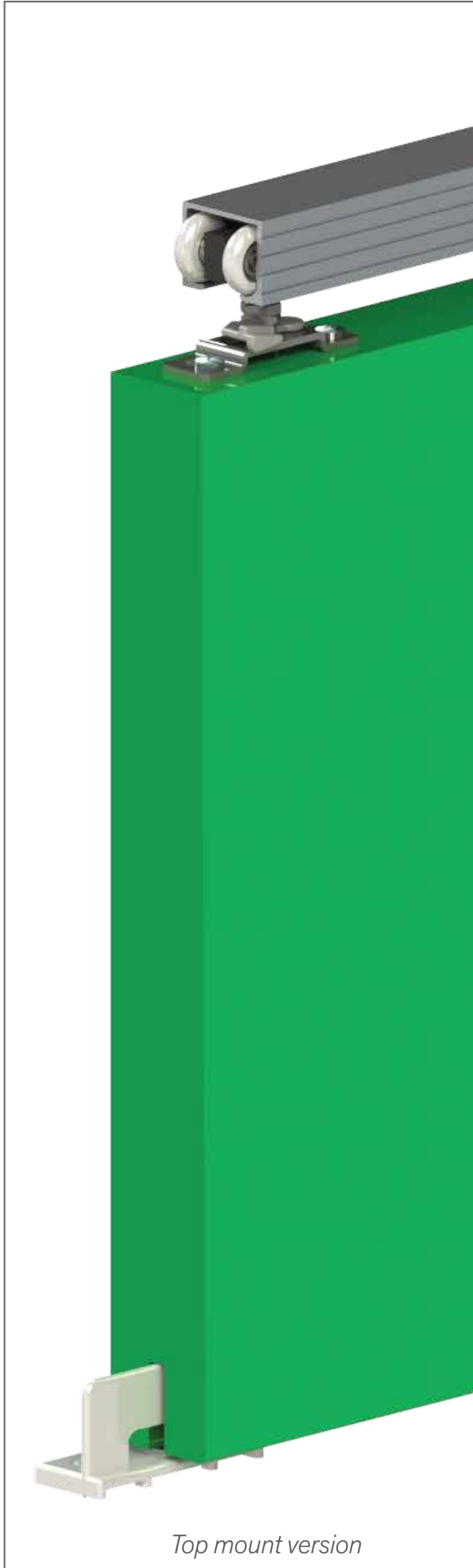

Top mount version



Wall mount version

SLIDING DOOR TRACK SYSTEM

APPLICATION



Featuring robust steel components combined with large, high-density rollers, this system is not only smooth and effortless to roll, it is extremely quiet in performance making it an ideal all-rounder for bathrooms, ensuites, laundries, bedrooms and hallways.

The Exposed 90 system comes in a complete boxed set including all the hardware components, track and fittings for one door up to 1220mm wide.

FEATURES

- Choice of Stainless Steel or Powder Coat Black
- Robust hangers with large ergonomic wheels
- Pre-drilled steel track with wall mount fittings
- Suits both glass and timber doors up to 90kg
- Fixing hardware and easy-to-follow instructions
- Optional Track Joiner available

DETAILS

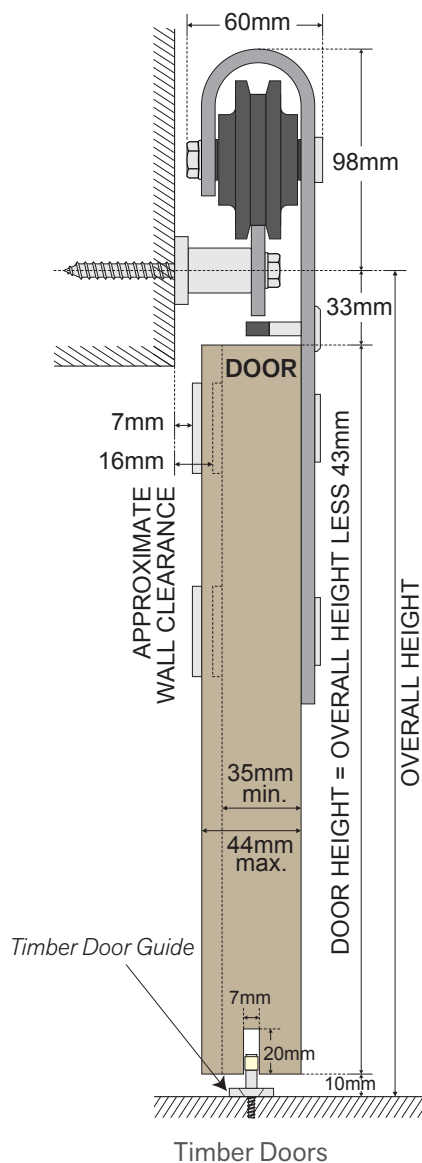
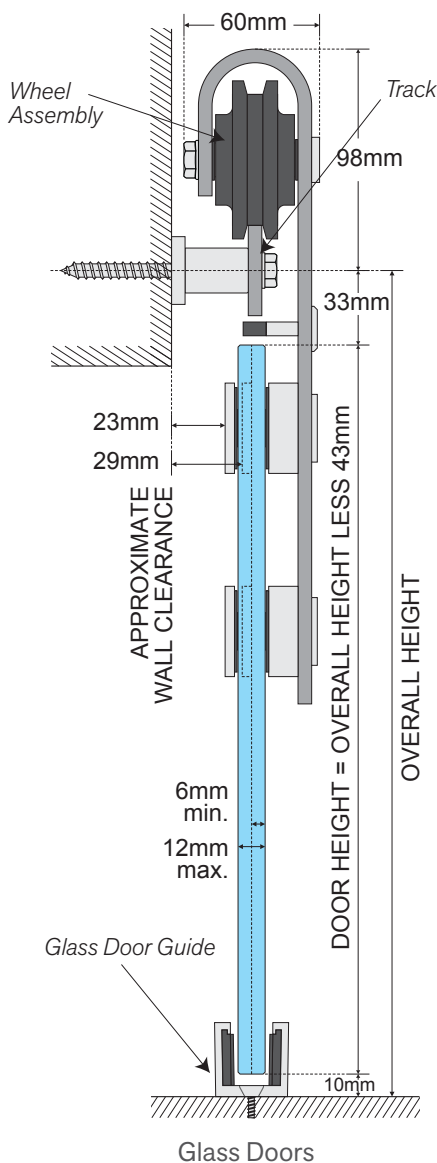

TECHNICAL SPECIFICATIONS

| | |
|-------------------------------|----------------------|
| Major Components (SS): | 304 Stainless Steel |
| Major Components (Black): | Mild Steel |
| Track (Pre-drilled): | 2450mm 40mm x 6mm |
| Roller: | |
| Wheel: | High density polymer |
| Load: | 90kg/panel |
| Max. Opening Width: | 1220mm |
| Min. Door Thickness (Timber): | 35mm - 44mm |
| Min. Door Thickness (Glass): | 6mm - 12mm |

* Full product codes & options refer to **page 81**



COMPONENTS



Wheel assembly



Wall spacer & bolt



Track stop



Glass door guide



Timber door guide



Stainless steel track - 2450mm (pre-drilled)

* *Stainless Steel components shown above.*

** *Some black version components will vary slightly.*

SLIDING DOOR TRACK SYSTEM

APPLICATION



The Trojan is a heavy, smooth and quiet top-hung system, designed for single internal doors in top-mount and wall-mount applications. The enclosed slim line track design allows for a more secure system as the wheels cannot jump off the track.

FEATURES

- Internal doors wall mount & top mount
- Wrap around aluminium track - wheels cannot jump off track
- Nylon tyred 4 wheel carriages with lubricated steel ball bearings for smooth and quiet operation
- Anti-bounce end stop
- Suits door thickness 28mm and above
- Quick-release wheel assemblies
- Optional wall mount bracket available
- Optional Glass Clamps pack available (80kg per door)

DETAILS

TECHNICAL SPECIFICATIONS

| | |
|-------------------------|--------------|
| Suits: | Single doors |
| Max. Door Width: | 1500mm wide |
| Door Thickness: | 28mm min |

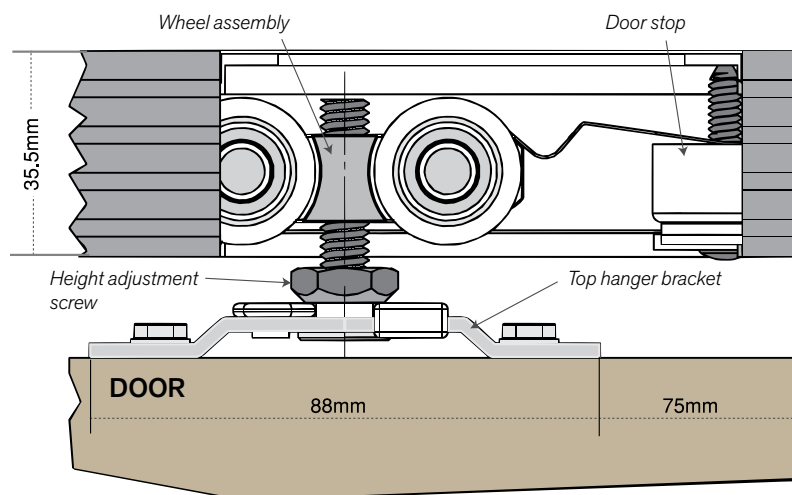
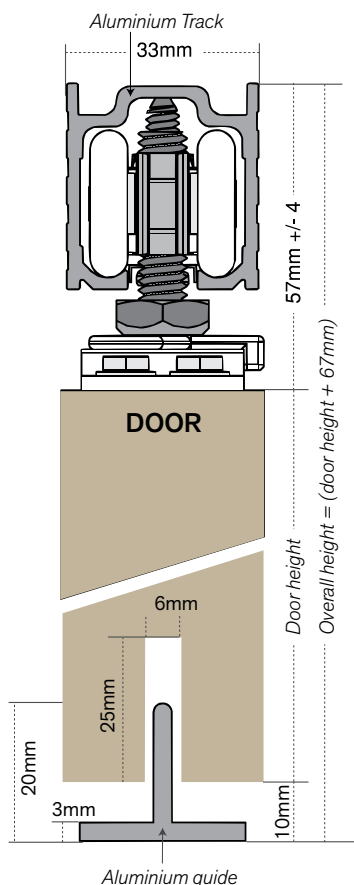

* Full product codes & options refer to **page 81**

COMPONENTS



Aluminium track



Quick-release
wheel assembly



Track wall
mount bracket
(Optional extra)



Door stop



Aluminium guide

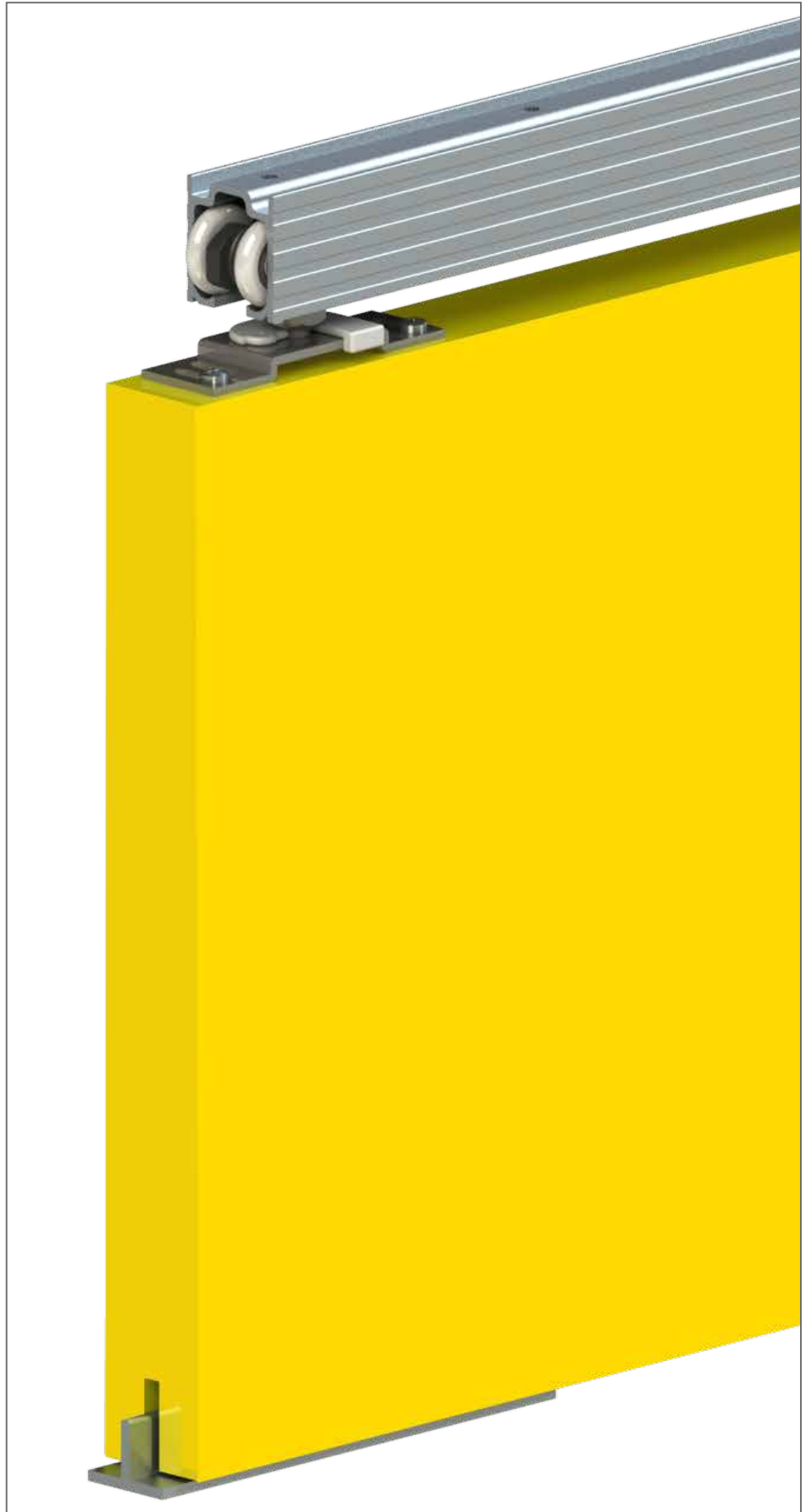

SLIDING DOOR TRACK SYSTEM

APPLICATION



The Allweather is a top-hung system designed for heavy doors in internal or external applications. Features include the robust aluminium enclosed track, concave nylon-tyre wheel assemblies and Stainless steel components.

Combined with smooth running and whisper quiet operation makes the Allweather the perfect choice for both domestic and architectural applications.

FEATURES

- Stainless steel components
- Clear anodised aluminium track
- 4-wheel carriage with concave tyre wheels
- Rolling bottom door guide
- Concealed door stop
- Optional wall & side-fix brackets
- Optional frameless glass door clamps

DETAILS

TECHNICAL SPECIFICATIONS

| | |
|----------------------------|----------------------------------|
| Min-Max Door Width: | 600mm - 2500mm |
| Door Thickness: | 30mm min - 100mm max |
| Min Opening Height: | Door Height + 92mm (Top mount) |
| Min Opening Height: | Door Height + 162mm (Wall mount) |

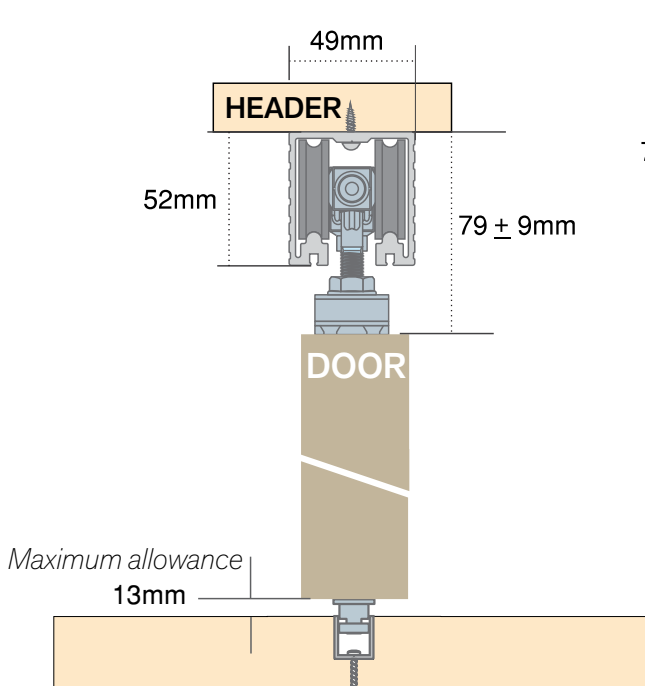

Standard Installation

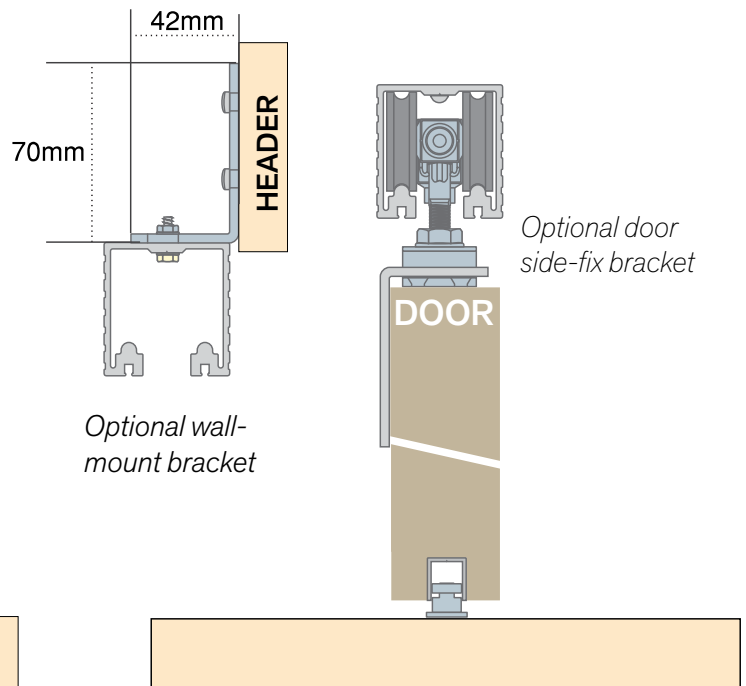

Optional bottom guide fitting
(inverted guide channel)

Optional Installation

* Full product codes & options refer to **page 81**

COMPONENTS



Aluminium track



Concealed door stop



Wheel assembly



Roller guide



Aluminium guide channel



Wall-fix bracket
(Optional extra)



Door Side-fix bracket
(Optional extra)



Glass Door Clamp
(100kg per door)
(Optional extra)



Glass Door Guide
(Optional extra)

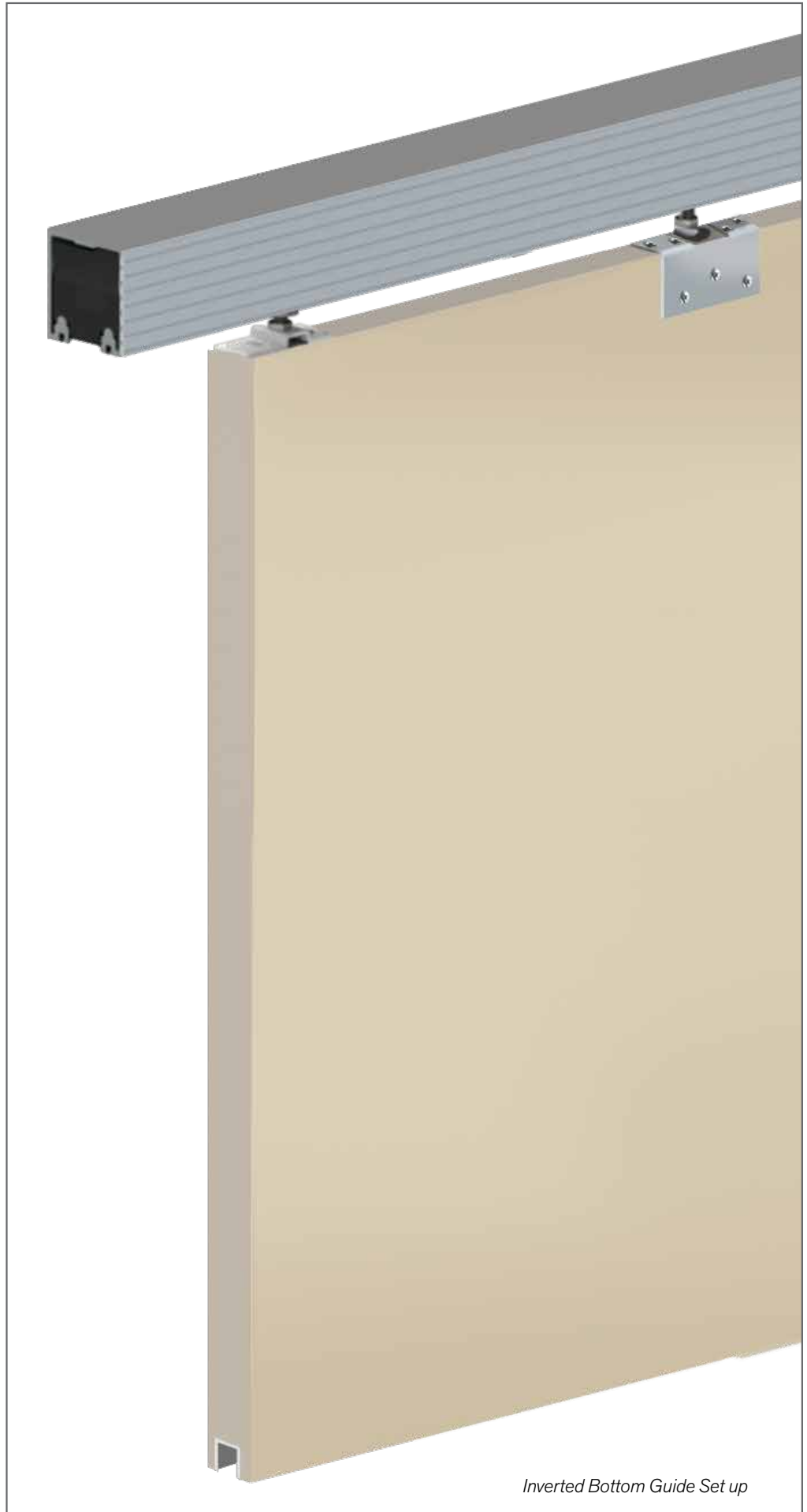

Inverted Bottom Guide Set up

SLIDING DOOR TRACK SYSTEM

APPLICATION



The Glidemaster is a sliding door track system, capable of supporting a maximum capacity of up to 272kg per door. Featuring an aluminium single track and adjustable anti-lift guide roller, the system is suitable for exposed conditions ranging from -30 degrees to 120 degrees.

FEATURES

- Aluminium single track
- High strength ertalon wheel with precision ball bearing race
- Suitable for exposed conditions from - 30° degrees to 120° degrees
- Adjustable anti-lift guide roller
- Rack and pinion height adjustment
- Suits door thickness 38mm & above
- Optional Coolroom track

DETAILS

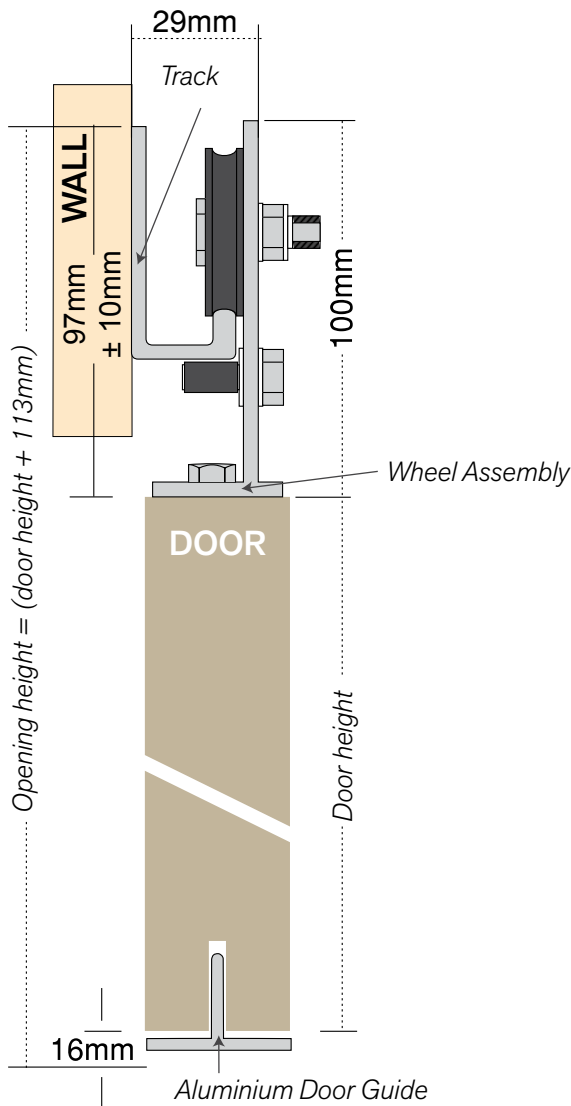

TECHNICAL SPECIFICATIONS

| | |
|-------------------------|--------------|
| Suits: | Single doors |
| Max. Door Width: | 1500mm wide |
| Door Thickness: | 38mm min |

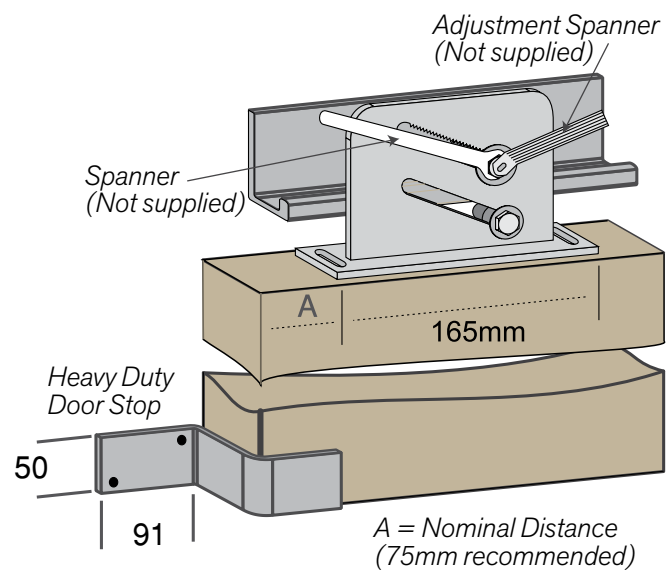

Minimum door thickness 38mm

* Full product codes & options refer to **page 82**

COMPONENTS



Aluminium track



Wheel assembly



Track mounted door stop



Heavy duty door stop - floor



Aluminium door guide

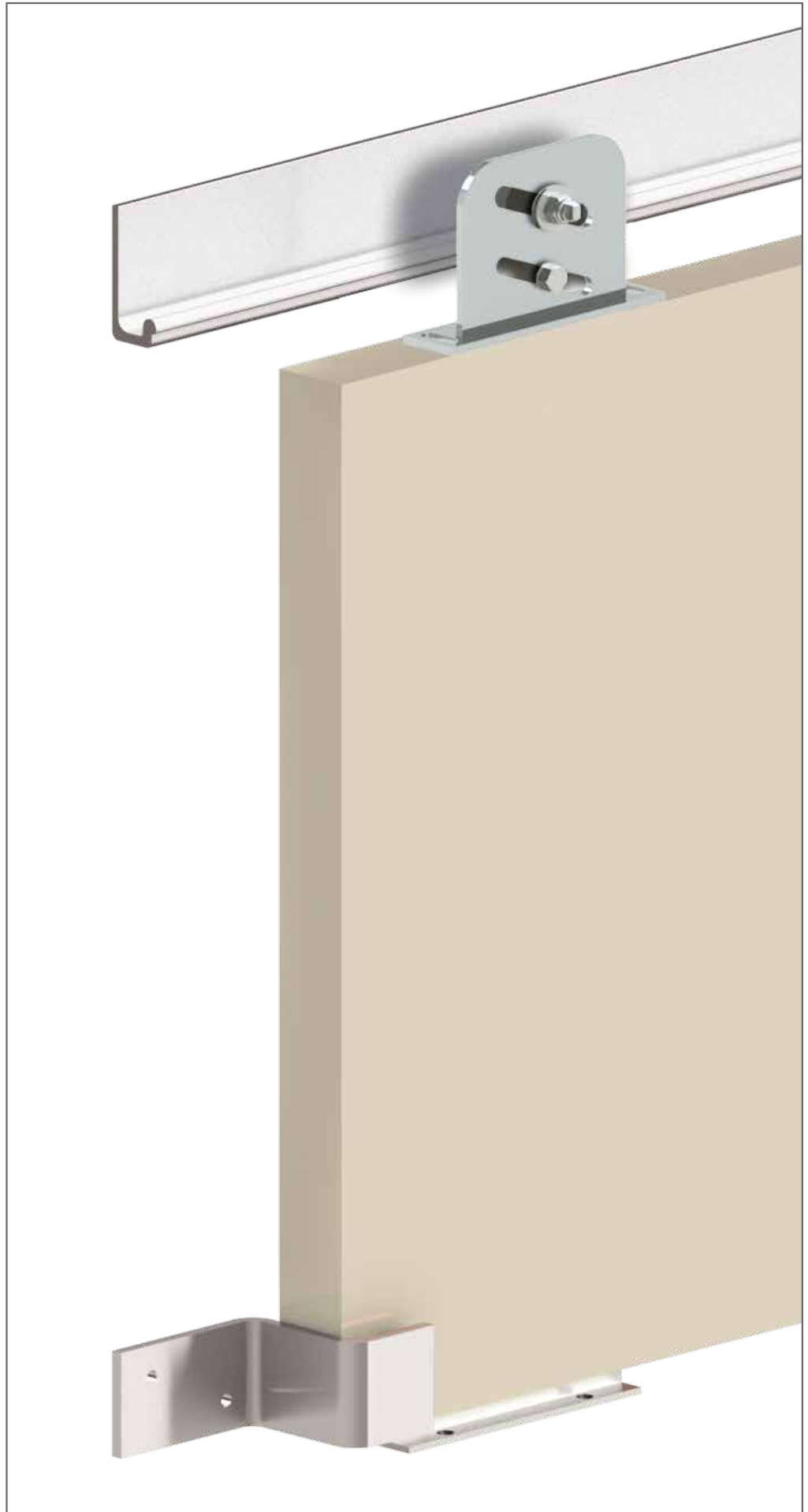

SLIDING DOOR TRACK SYSTEM

APPLICATION



A robust heavy duty system with a choice of assembly options, Industro can be used for a variety of door weights and applications. The enclosed track design allows for a more secure system as the wheels cannot jump off the track.

FEATURES

- Super heavy duty - ideal for farm sheds and industrial/commercial applications
- Two wheel assembly - 300kg per door
- Four wheel assembly - 450kg per door
- Galvanised steel track - pre-punched
- Top mount or wall mount applications optional
- Optional bottom roller guide system
- Suits door thickness of 32mm & above

DETAILS

TECHNICAL SPECIFICATIONS

| | |
|-------------------------|-------------------------------------|
| Suits: | Single doors |
| Max. Door Width: | 2900mm wide (per standard track) |
| Door Thickness: | 32mm min |

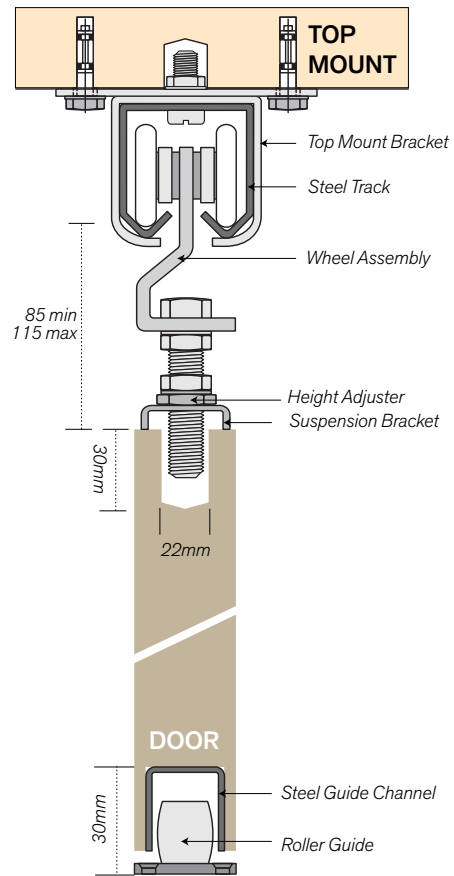
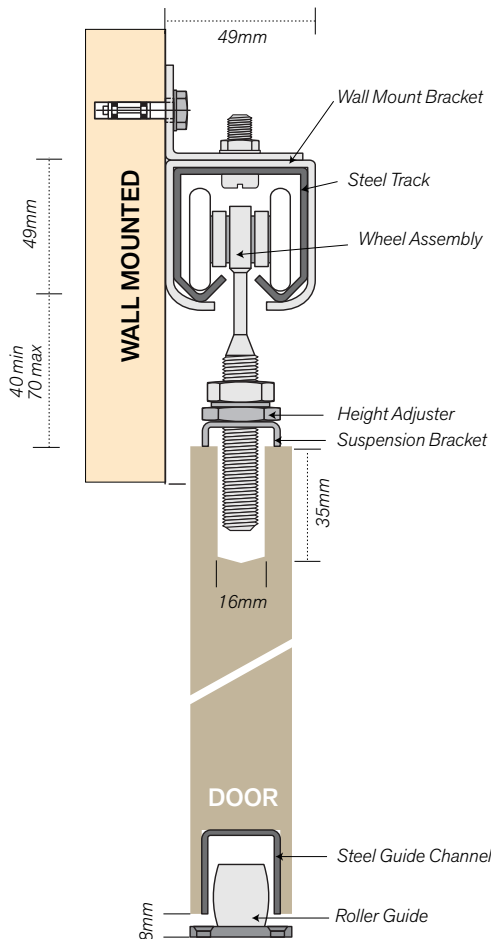

* Full product codes & options refer to **page 82**

COMPONENTS



Steel track



Top mount bracket
(Wall & double wall
mount available)



Track joiner
(Optional extra)



Door stop



Suspension bracket
(2 options available)



Wheel assembly
(5 options available)



Roller guide



Steel guide channel

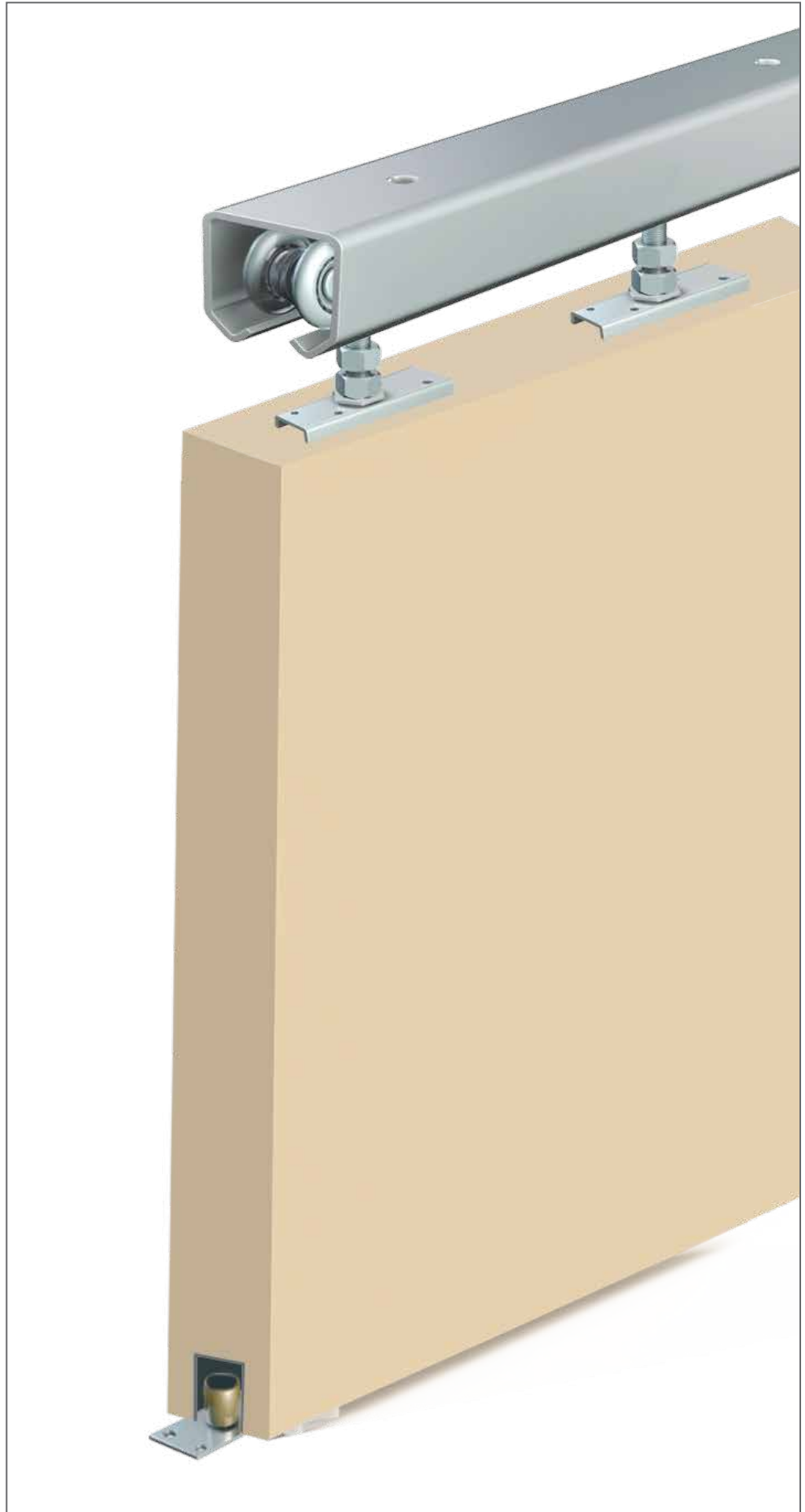

BI-FOLDING DOOR TRACK SYSTEM



The Barracuda is a simple bi-fold system suitable for two pair door arrangements, or replacing single sliding or hinged doors with one pair of bi folding doors.

FEATURES

- Aluminium Track - attractive ribbed face
- Nylon and zinc plated steel components
- Suits 2 and 4 panels
- Light duty
- Simple Installation
- Optional door aligners available

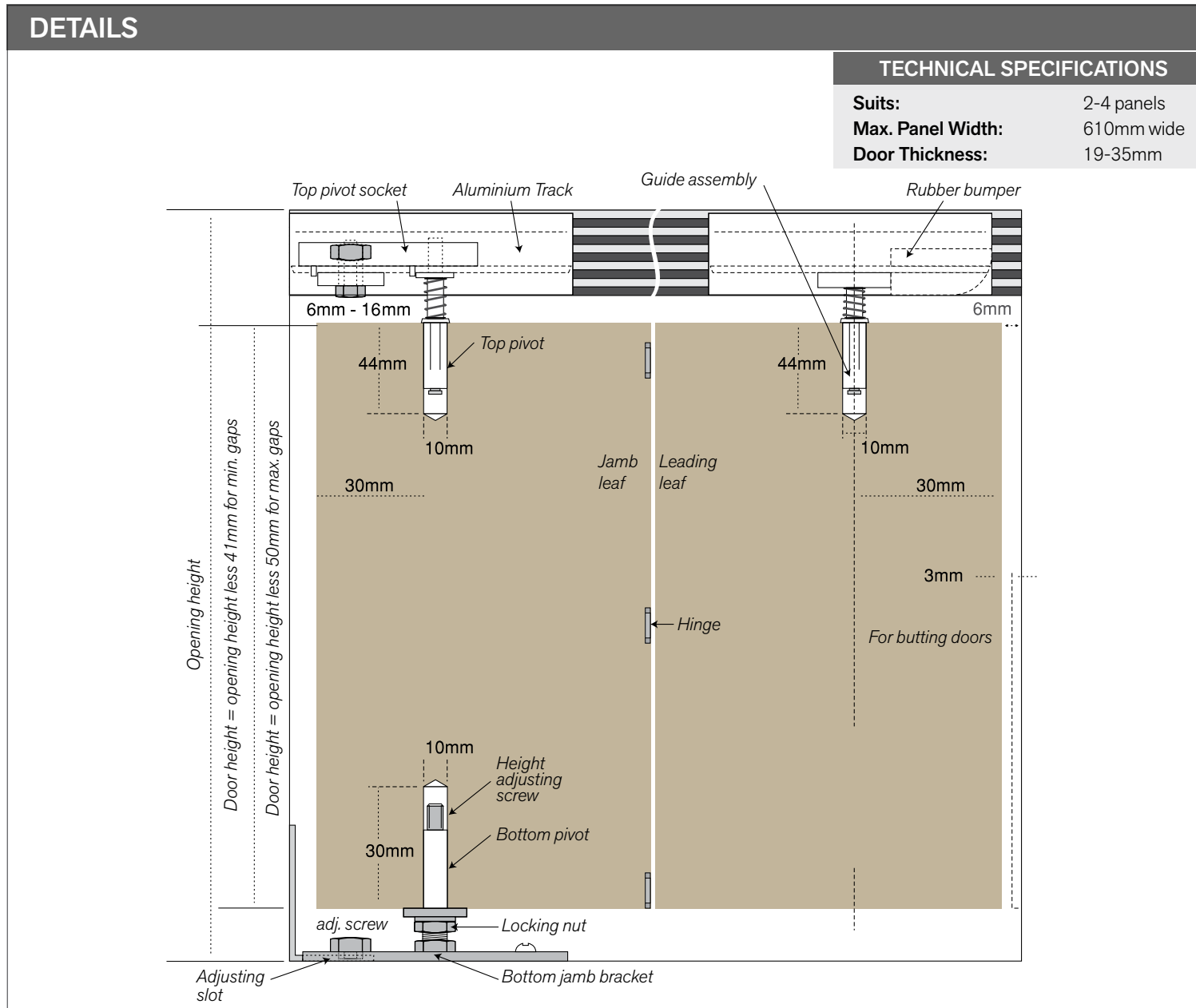

* Full product codes & options refer to **page 82**

COMPONENTS



Aluminium track



Top guide

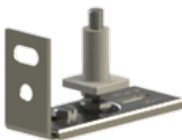

Bottom pivot set



Hinges



Top pivot set

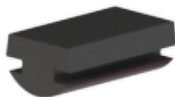

Rubber bumper

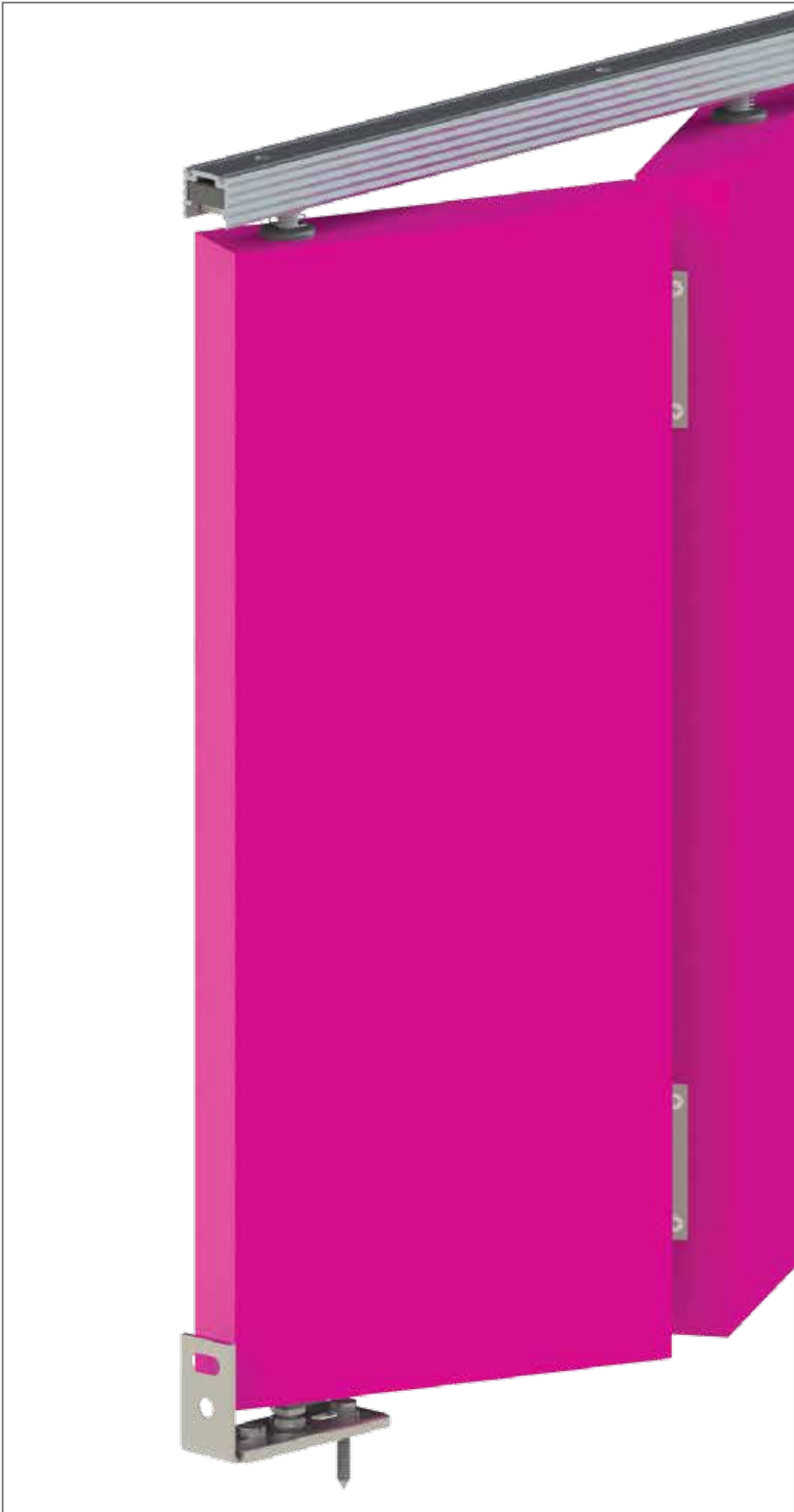

CONCEALED BI-FOLDING DOOR TRACK SYSTEM

APPLICATION



The Triumph Stealth is a concealed bi-folding door track system, ideally suited to doors up to 1000mm high. The door track system features wrap around aluminium track and specially designed centre hinges for accurate door alignment. The Triumph Stealth has a maximum recommended panel width of 600mm and can support a maximum of 22kg per panel.

FEATURES

- Wrap around aluminium track - available in mill finish and clear anodised
- Ideally suited to doors up to 1000mm high but may be adapted to suit doors up to 2100mm high (additional hinges required)
- Maximum recommended panel width 600mm

DETAILS

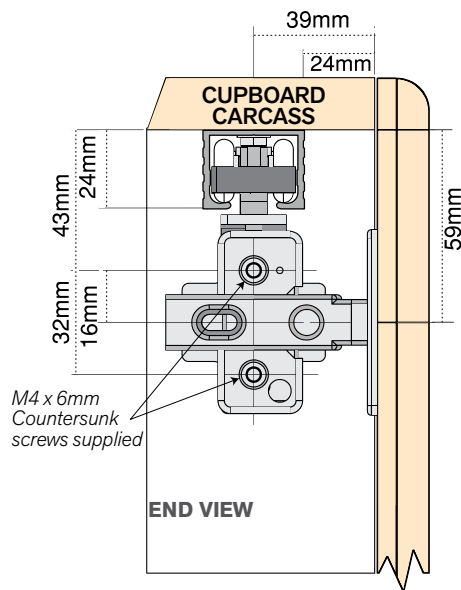

TECHNICAL SPECIFICATIONS

| | |
|-------------------------|------------|
| Suits: | 2 panels |
| Max. Door Width: | 600mm wide |
| Door Thickness: | 16-25mm |

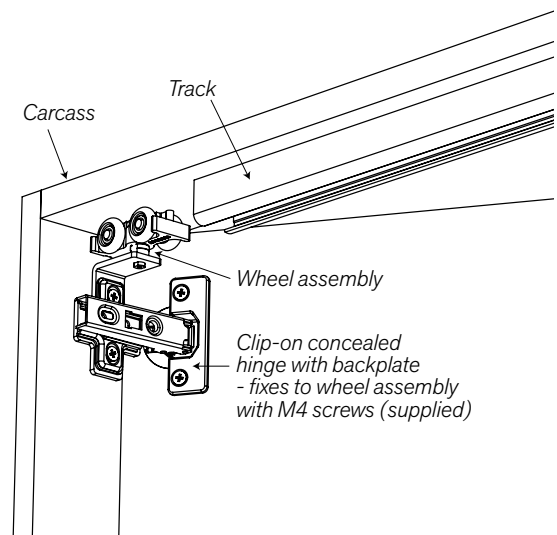
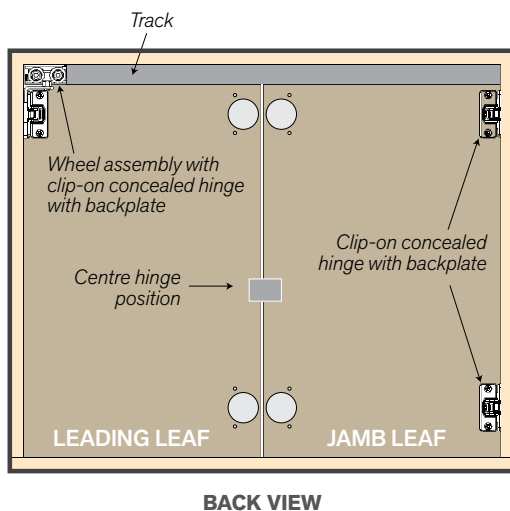

* Full product codes & options refer to **page 82**

COMPONENTS

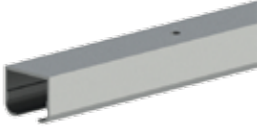

Aluminium track

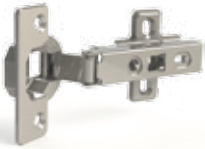

Concealed hinge
& back plate



Intermediate hinge



Wheel assembly



CONCEALED BI-FOLDING DOOR TRACK SYSTEM

APPLICATION



The Overlay Bi-Fold is a bi-folding door track system designed for wardrobe doors, large cupboard doors, pantries, closets and concealed rooms in confined areas such as laundries. A built-in quick-release mechanism assists with trouble free fitting as well as allowing the doors to easily be opened out for access to internal adjustable shelves.

FEATURES

- Reversible components for left hand and right hand openings
- Wheel assembly hinges and guide assembly hinges are interchangeable
- Available in clear anodised and white
- Optional bottom guide

DETAILS

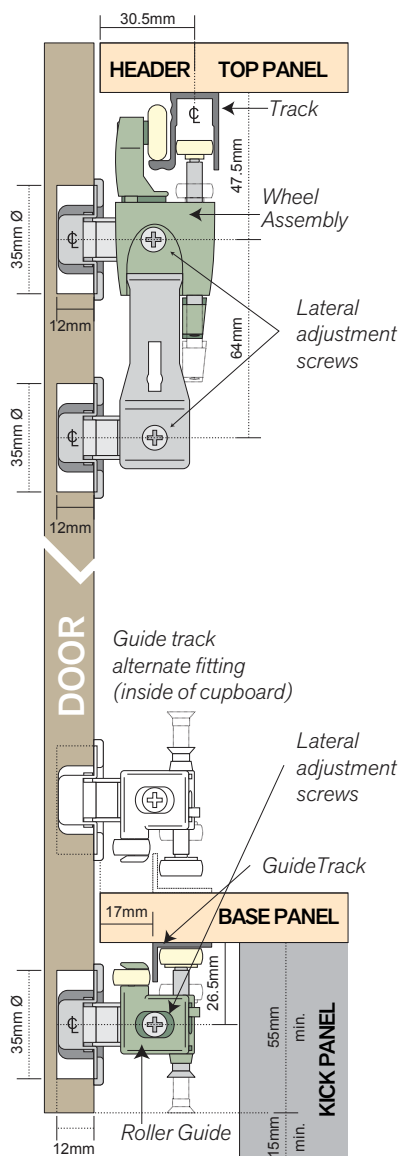

| TECHNICAL SPECIFICATIONS | |
|---------------------------|-----------------|
| Suits: | 2 panels |
| Max. Panel Width: | 500mm per panel |
| Max. Panel Height: | 2400mm |
| Door Thickness: | 16-25mm |

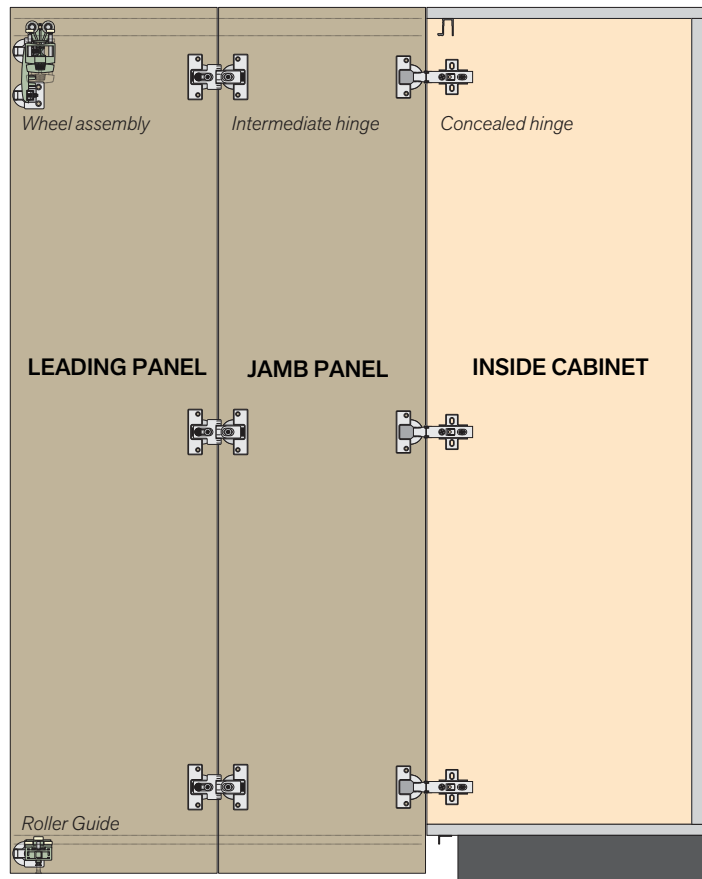

* Full product codes & options refer to **page 83**

COMPONENTS



Track



Concealed hinge & backplate



Intermediate hinge



Wheel assembly



Roller guide



Guide track



FOLDING DOOR TRACK SYSTEM

APPLICATION



The Triumph Folding Door Track System uses a wrap around track. It also features a four nylon tyred, fully sealed ZZ ball bearing carriage for quiet and smooth operation. The pivots are made out of brass for durability and are designed to handle a substantial amount of weight without a guide.

FEATURES

- End pivoting - up to 18kg per panel no guide
- Centre-pivoting - up to 25kg per panel no guide
- High strength height adjusting pivot
- Wrap around aluminium track in mill & clear anodised
- Brass pivot for long life and ease of adjustment
- Standard with chrome hinges - optional hinge colours of brass plated and powder coat silver available

DETAILS

TECHNICAL SPECIFICATIONS

| | |
|--------------------------|-----------------|
| Suits: | Up to 8 panels |
| Max. Panel Width: | 820mm per panel |
| Door Thickness: | 25mm min |

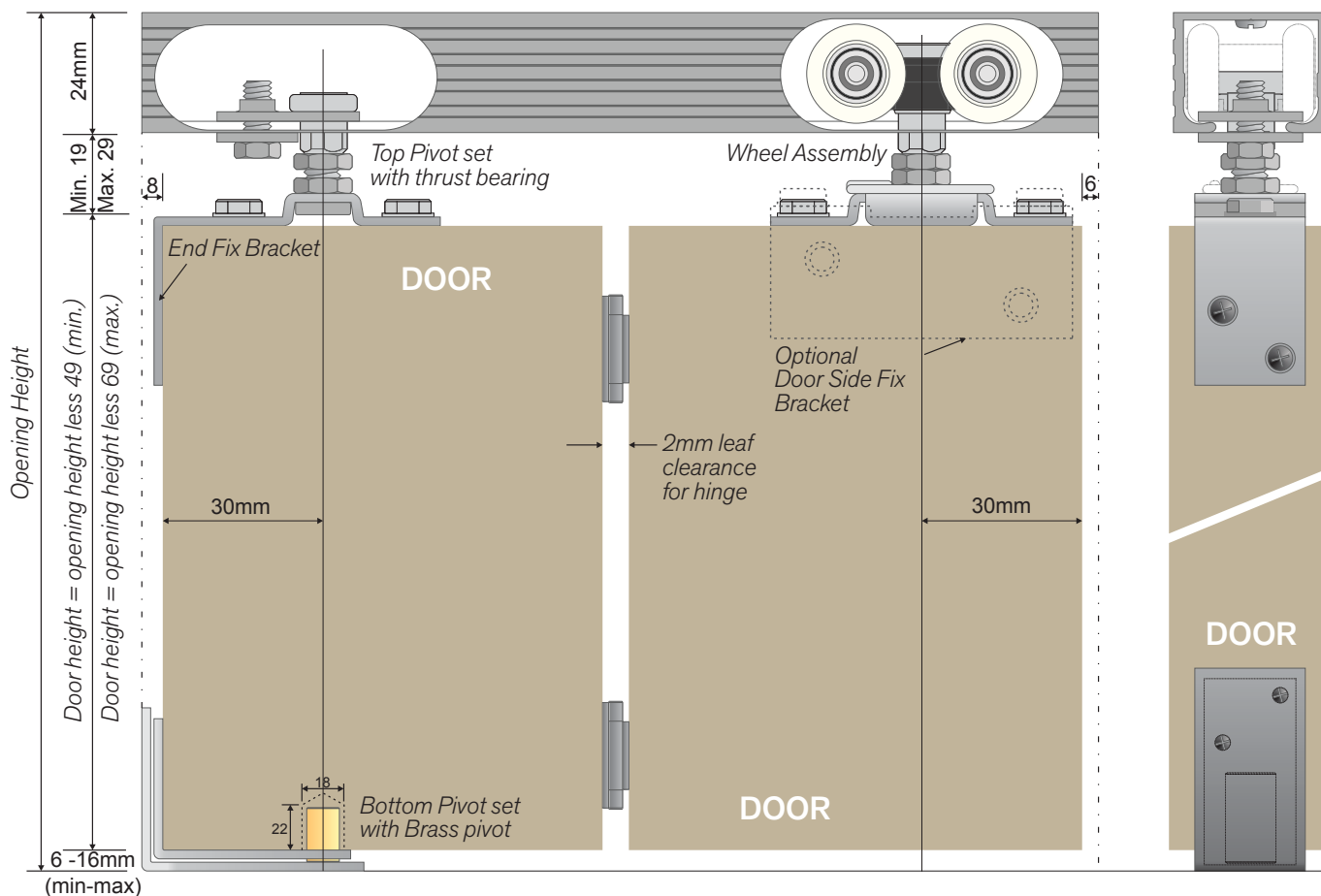

* Full product codes & options refer to **page 82**

COMPONENTS



Top mount track



Quick-release wheel assembly



Top pivot set



Door side fix bracket
(Optional extra)



Hinges



Bottom pivot set

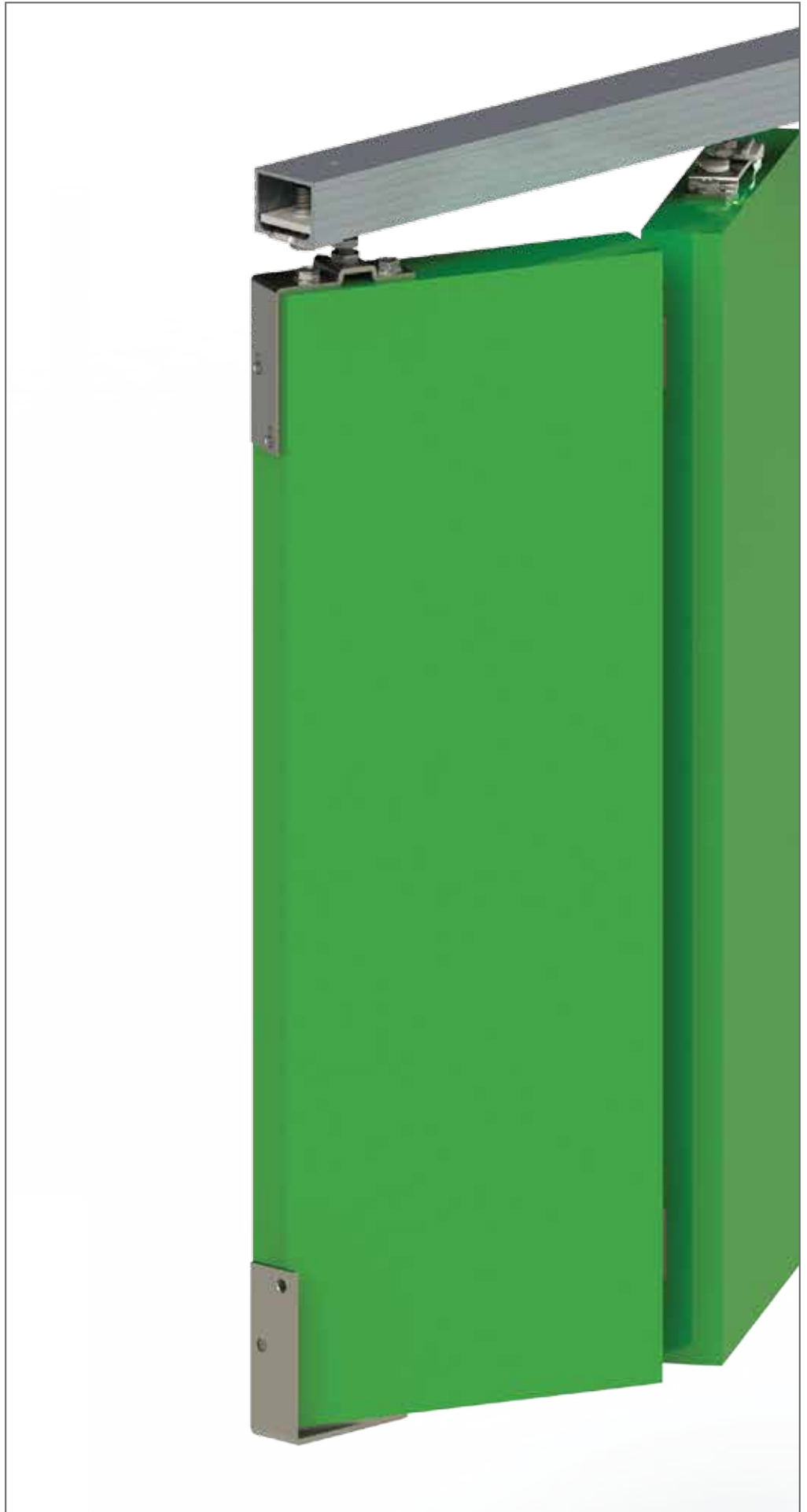

FOLDING DOOR TRACK SYSTEM

APPLICATION

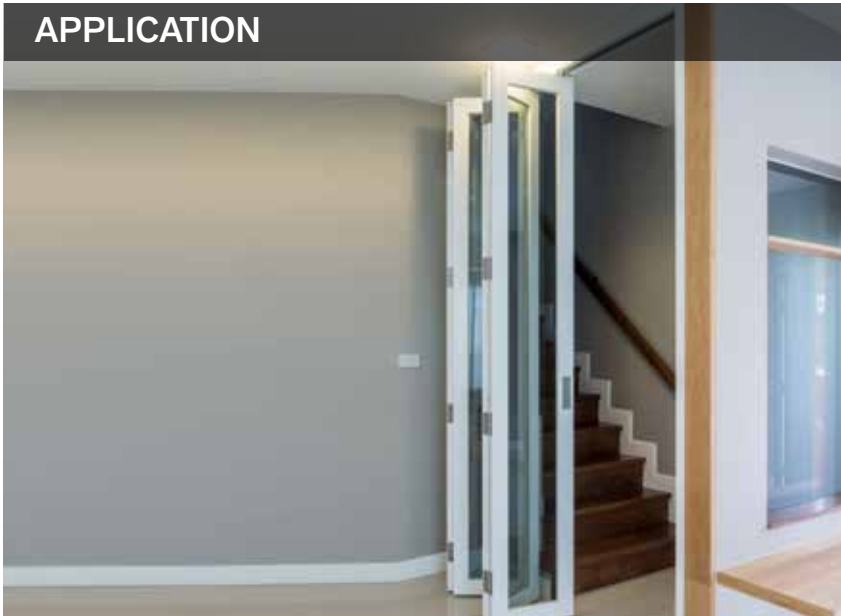

The Allweather internal folding system is a robust multi-folding system designed for heavy doors in a folding application.

FEATURES

- Aluminium clear anodised track
- Ribbed face for aesthetic appeal
- Enclosed track to increased security
- Stainless steel for external or internal use
- 4-wheel carriage with concave tyred wheels
- Bearings are sealed ZZ bearings
- Height adjustable without locknut
- Carrier incorporates rubber bumpers

DETAILS

TECHNICAL SPECIFICATIONS

| | |
|--------------------------|---------------------|
| Suits: | Up to 8 panels |
| Max. Panel Width: | 600-900mm per panel |
| Door Thickness: | 32mm min |

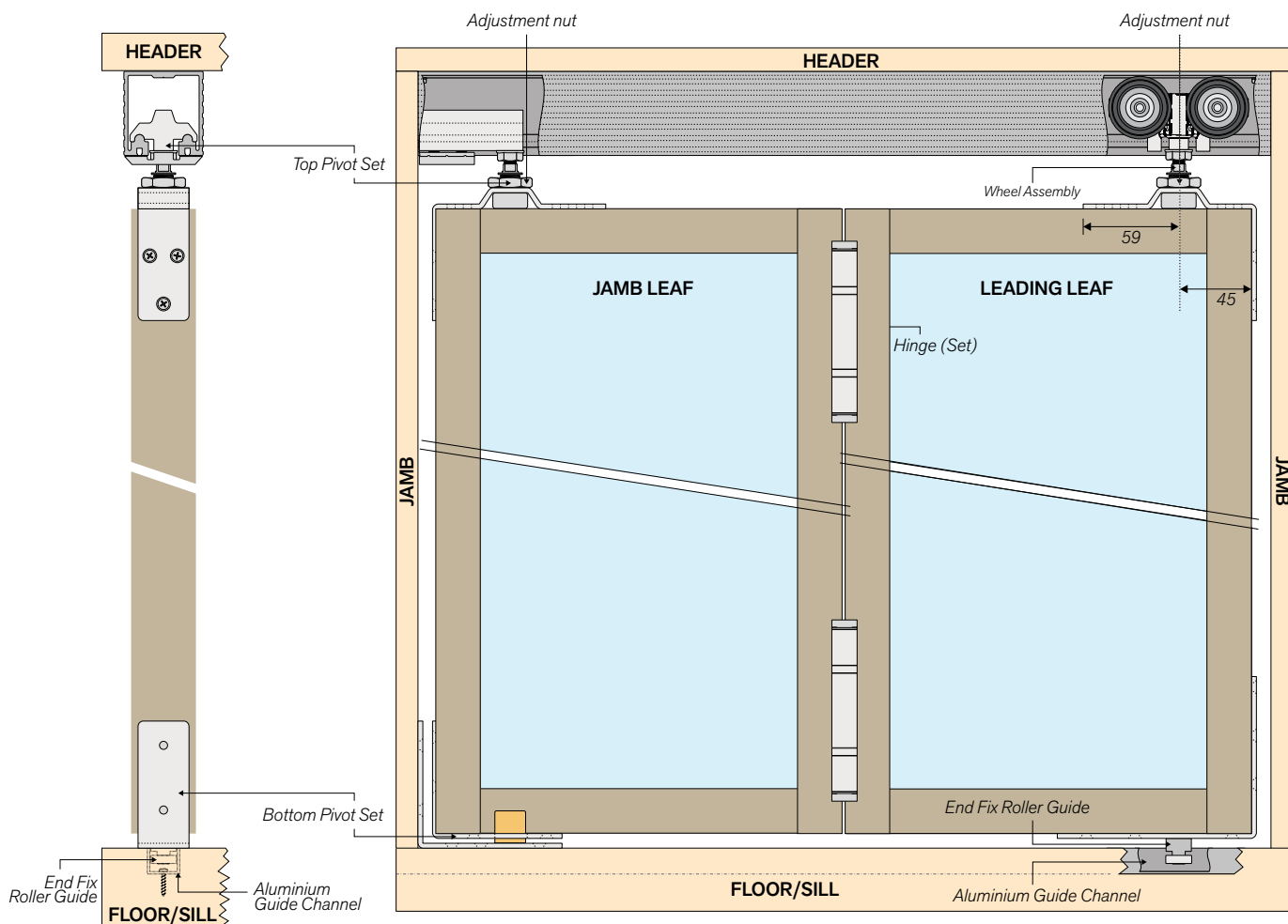

* Full product codes & options refer to **page 81**

COMPONENTS



Aluminium track



Top pivot set



Bottom pivot set



Wheel assembly



End fix roller guide



Aluminium guide channel



Standard hinge set



Handle hinge set



FOLDING DOOR TRACK SYSTEM

APPLICATION



The AllWeather External Bi-Fold Door System is a recent addition to the Cowdroy range. A durable and versatile product, designed for the diverse environments of Australia. The system features complete adjustment capabilities at every hanger and pivot point including a unique lateral adjustment top pivot.

FEATURES

- Stainless steel top hinge roller assembly for strength & corrosion resistance
- Heavy duty rollers made of engineering polymer for smooth operation
- D pull stainless steel hinge for easy operation
- Stainless steel roller guide for added strength & corrosion resistance
- Flushbolts available in locking & non-locking

DETAILS



Pivot Set with middle hinge anchor

Intermediate Hanger & Guide Set

Standard Hinge Set
Offset Hinge Set

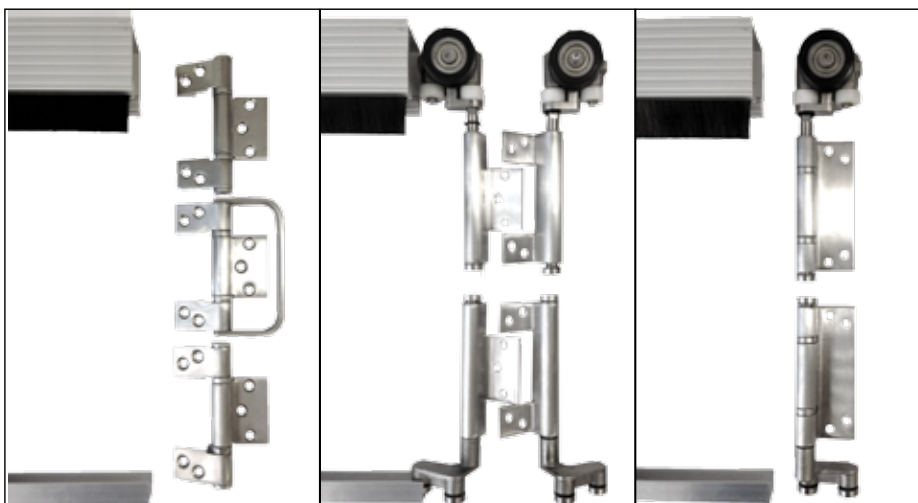

Standard D Handle Hinge Set
Offset D Handle Hinge Set

Meeting Hanger & Guide Set

End Hanger & Guide Set

TECHNICAL SPECIFICATIONS

| | |
|-------------------------------|----------------|
| Suits: | Up to 8 panels |
| Acceptable Panel Size: | 900 x 3000mm |
| Track Length: | 6000mm |
| Door Thickness: | 35mm min |
| Max. Opening Width: | 12000mm |

DOOR WIDTH CALCULATION

Formula:

Opening Width (**OW**)
 Number of Doors (**ND**)
 Jamb Gap (**JG**) = 10mm (2 x 5mm)
 Hinge Gaps (**HG**) = (**ND** - 1) x 4mm
 Door Width (**DW**)

$$DW = \frac{OW - (JG) - (HG)}{ND}$$

OPENING HEIGHT = Top of Track to
 Top of Guide Channel

DOOR HEIGHT = OPENING HEIGHT
 LESS 70mm
 (for minimum gap / tight tolerance)

DOOR HEIGHT = OPENING HEIGHT
 LESS 75mm
 (for larger gap / 5mm adjustment)

* Full product codes & options refer to **page 81**

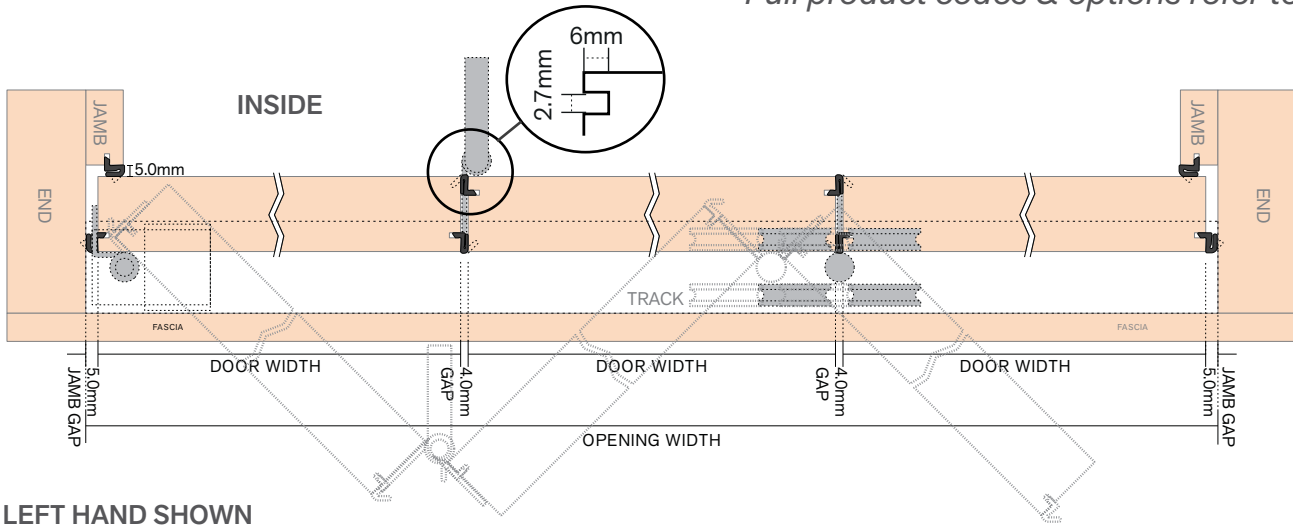

LEFT HAND SHOWN

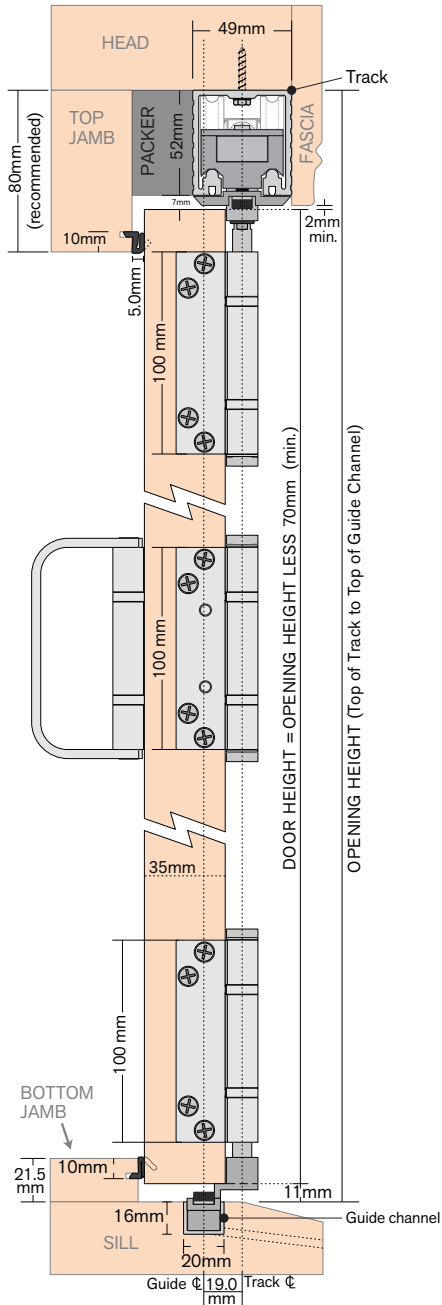

Main Door Locking Options:

Timber Doors:

45mm or 60mm

Backset
Mortice Lock

Aluminium Doors:

Twin Point Bi Fold Lock
incl. handle and Euro Cyl.



Locked Unlocked

Secondary Locking Options:



Flushbolts range available in
both Round Top & Square Top:

140mm Locking (C4 cylinder)
140mm Non-Locking
210mm Locking (C4 cylinder)
210mm Non-Locking
400mm Non-Locking

Door Furniture Options:

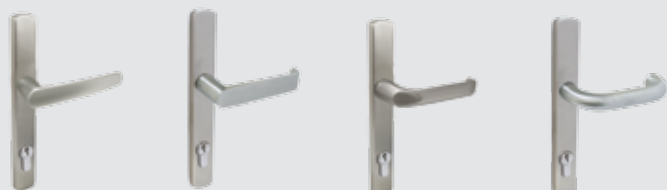

Swan

Tumut

Hunter

Manly

SLIDING WARDROBE AND CUPBOARD DOOR TRACK SYSTEM

APPLICATION



The Quick-Fix is part of Cowdroy's sliding wardrobe and cupboard door track systems range. The system features nylon tyred wheels with ball bearings and height adjustment slot on race assembly. The adjustable gap between doors allows easy installation.

FEATURES

- Extruded aluminium track
- Track is pre-drilled
- Alternative door guides available
- Packaged in sets or component packs
- Suits door thick 19mm and above

DETAILS

TECHNICAL SPECIFICATIONS

| | |
|-------------------------|-----------|
| Suits: | 2-3 doors |
| Max. Door Width: | 950mm |
| Door Thickness: | 19mm min |

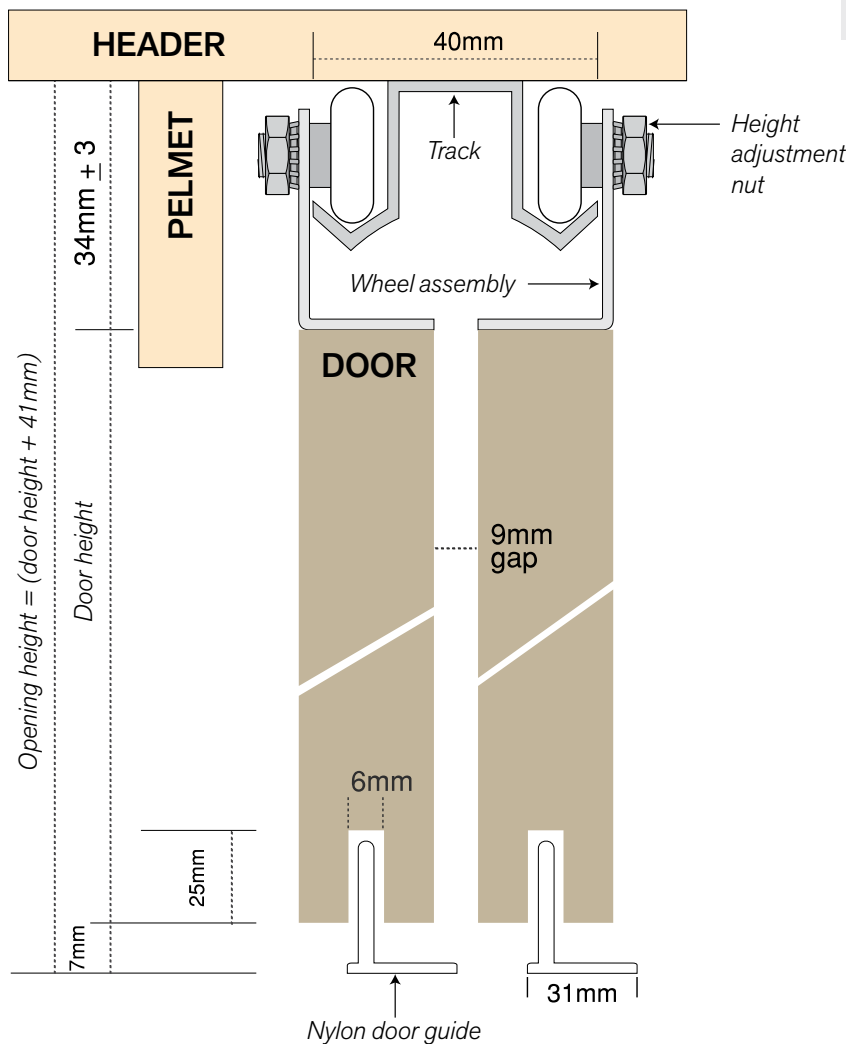

* Full product codes & options refer to **page 83**

COMPONENTS

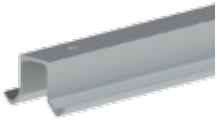

Aluminium
double track



Wheel assembly



Nylon door guide

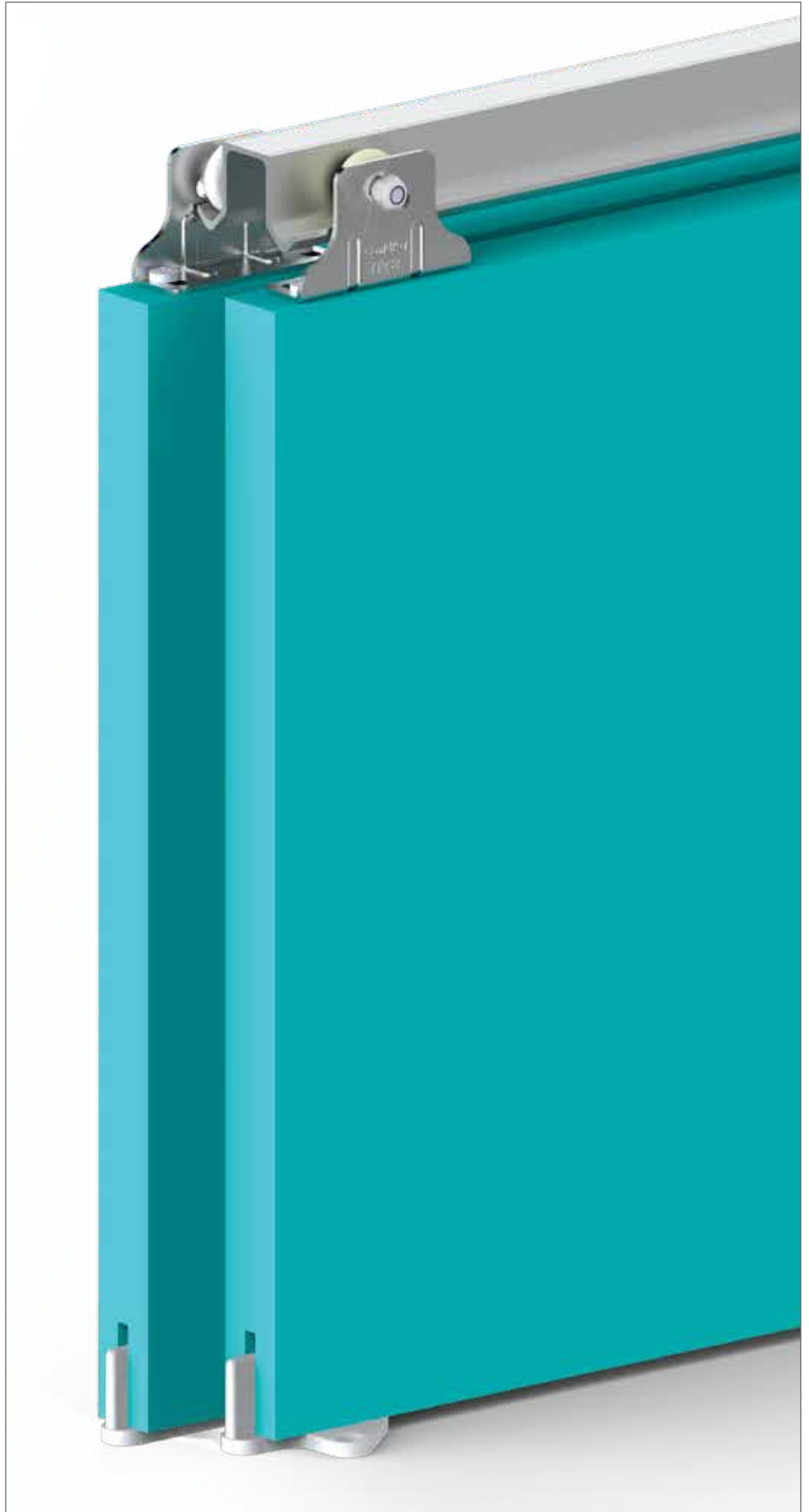

SLIDING WARDROBE AND CUPBOARD DOOR TRACK SYSTEM

APPLICATION



Robemaker is a smooth and quiet bottom rolling system suitable for 2, 3 and 4 door wardrobe applications. The attractive slimline design features a patented snap-on bottom track to give pleasing aesthetics - no unsightly track fixing screws and concealed wheels.

FEATURES

- Smooth running adjustable roller sheave
- Slimline aluminium extrusions - available in gloss white and clear anodised
- Suits 2, 3 and 4 door openings
- Reversible headguide channel - grooved face or smooth face
- Optional Jamb channel available in gloss white
- Robemaker Triple also available

DETAILS

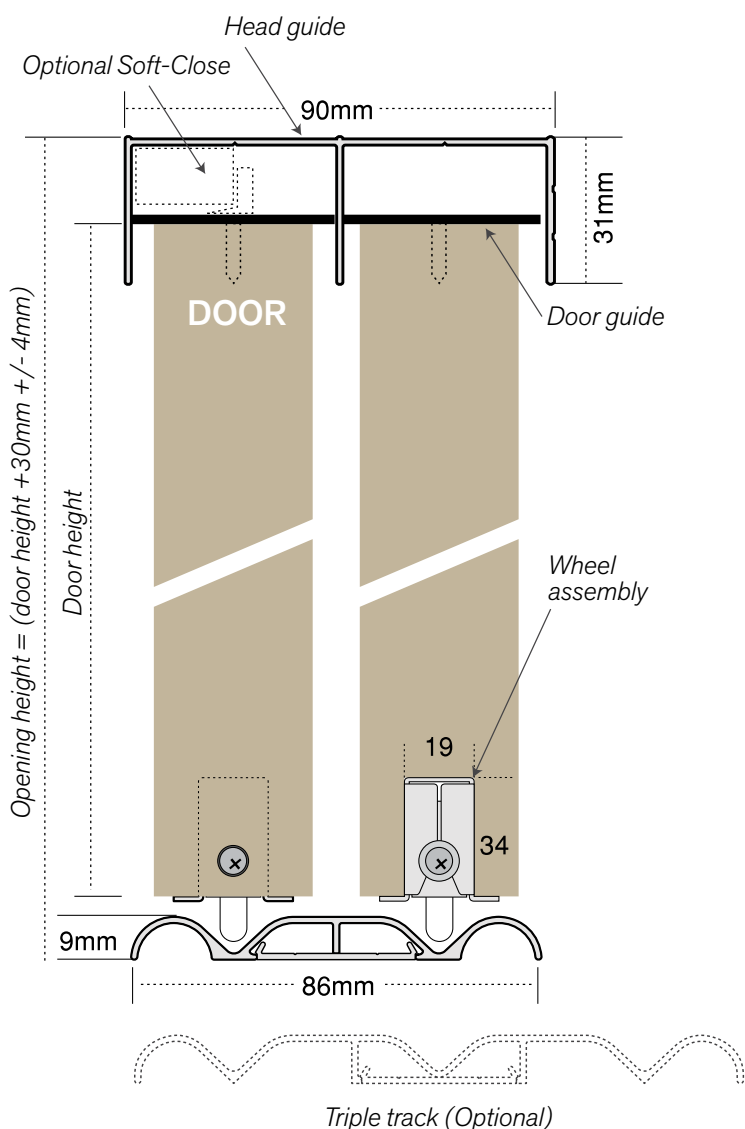

TECHNICAL SPECIFICATIONS

| | |
|-------------------------|------------|
| Suits: | 2-4 doors |
| Max. Door Width: | 820mm wide |
| Door Thickness: | 30-40mm |

ADD A SOFT-CLOSE KIT TO YOUR SYSTEM

Soft-Close options available on page 79



Soft-close adaptors are designed to slow the closing action of cabinet doors reducing noise and wear.

Roller Cut-Out Details:

34mm(H) x 72mm(W) x 19mm(D)

Door End View

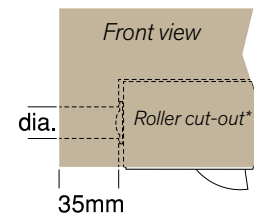

End of Door

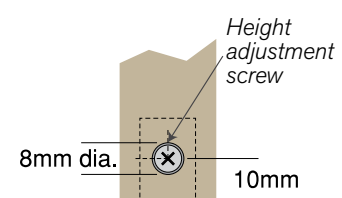

* Full product codes & options refer to **page 83**

COMPONENTS



Bottom track



Snap-strip



Wheel assembly



Door guide

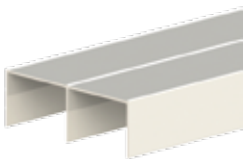

Head guide



Soft Close
(Optional extra)





MIRROR ROBE

SLIDING WARDROBE & CUPBOARD DOOR TRACK SYSTEM

* Full product codes & options refer to **page 83**

The Mirror Robe Sliding Wardrobe Door System is the latest addition to Cowdroy's sliding door track range. With a similar design to the Robemaker system, including the patented snap strip feature, the Mirror Robe can be used for either 2, 3 or 4 door applications.

The extruded aluminium mirror door frame includes horizontal rail trims and vertical handle trims with finger grip as well as a rubber bumper insert for anti-collision and protection of the vertical frame and jamb.

This system is currently sold as components only with all visible extrusions pre-finished in powder coat white. Other colours may be available to order – P.O.A.

FEATURES

- Suitable for both 4mm and 6mm thick mirror panels
- TT90500 Adjustable Roller Assembly locates easily into the rear of the door frame
- Height adjustment screw is fully accessible for convenient in-situ adjustment
- Anti-lift screw to eliminate 'door jumping'
- Can also be used with 19mm thick timber doors by excluding the mirror framing and fixing the adjustable roller assemblies directly to the rear of the door

| TECHNICAL SPECIFICATIONS | | | |
|--------------------------|---------------------------------|-------------|------|
| MIRROR ROBE | | | |
| CODE | DESCRIPTION | COLOUR | UNIT |
| TT56016 | Top Track 5000mm | White | EACH |
| TT56216 | Bottom Track 5000mm | White | EACH |
| TT56506 | Handle Bumper 100m | White | ROLL |
| TT56516 | Door Frame Handle 5000mm | White | EACH |
| TT56600 | Door Guide with Anti-lift screw | Black | EACH |
| TT56716 | Door Frame Rail 5000mm | White | EACH |
| TT90500 | Adjustable Roller Assembly | | EACH |
| TT58311 | Snap Strip 5000mm | Mill Finish | EACH |
| TT79318 | Wedge for 4mm Mirror Black 20m | Black | ROLL |

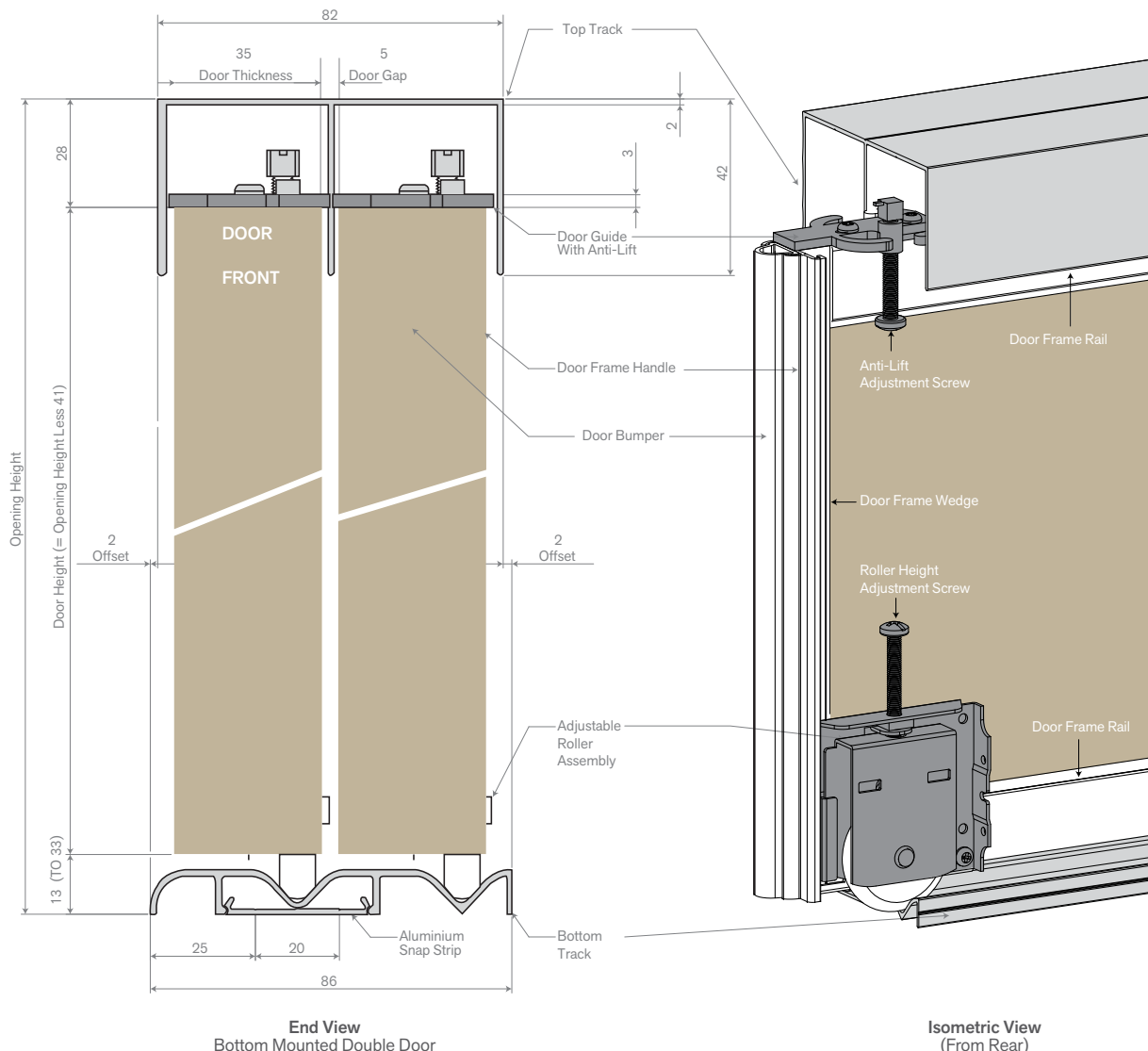

SLIDING CUPBOARD DOOR TRACK SYSTEM

APPLICATION

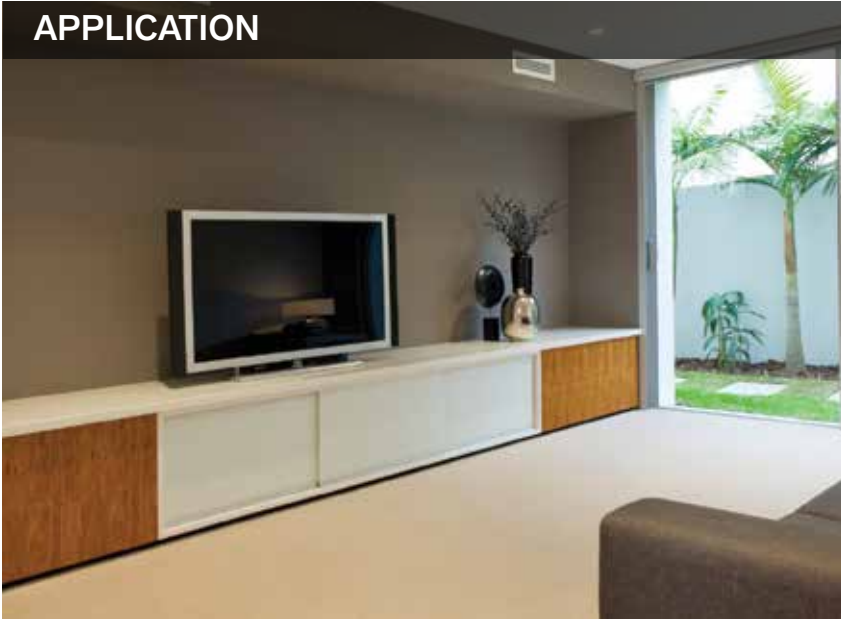

The Cabinetmaker is designed specifically for cabinets in residential and commercial properties. With a concealed fix bottom snap track, reversible headguide and slimline aluminium extrusions, the Cabinetmaker provides an upmarket look to complete your cabinet doors at an affordable price.

FEATURES

- Slimline aluminium extrusions pre-finished in clear anodised and powder coat white
- Reversible headguide - grooved face or flush face
- Bottom track snap-fixes to bottom fixing strip - no unsightly fixings
- Nylon roller with 10mm height adjustment
- Suits doors 15 to 18mm thick

DETAILS

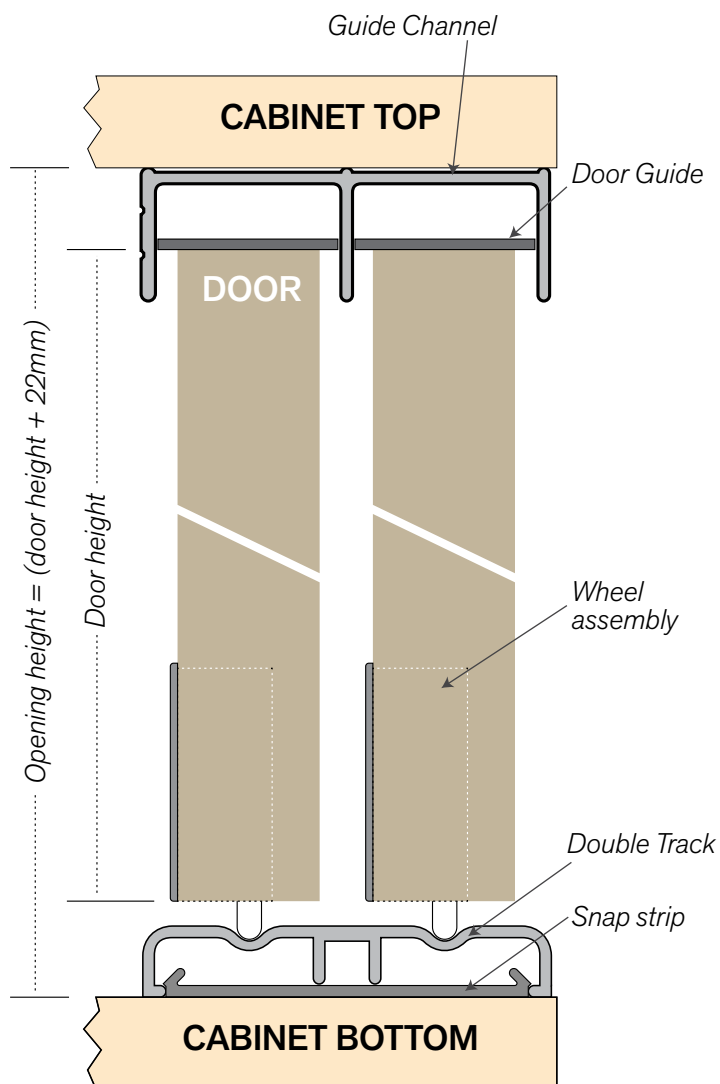

TECHNICAL SPECIFICATIONS

| | |
|-------------------------|------------|
| Suits: | 2-3 doors |
| Max. Door Width: | 650mm wide |
| Door Thickness: | 15-18mm |

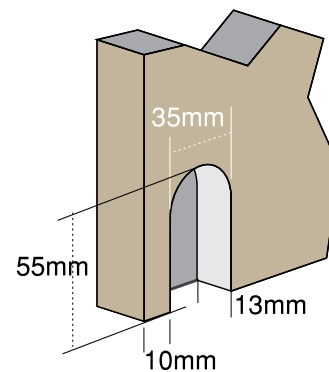
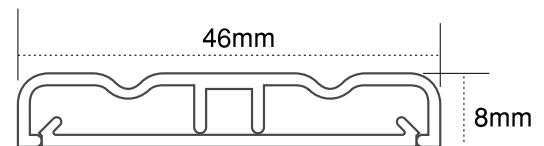
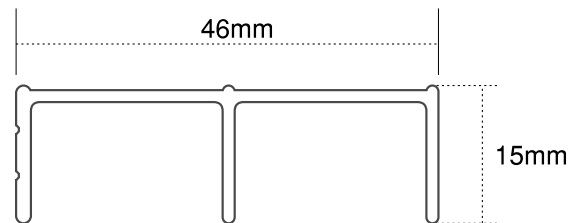

Roller cut out back view

* Full product codes & options refer to **page 84**

COMPONENTS



Double track



Snap-strip



Wheel assembly



Door guide



Guide channel

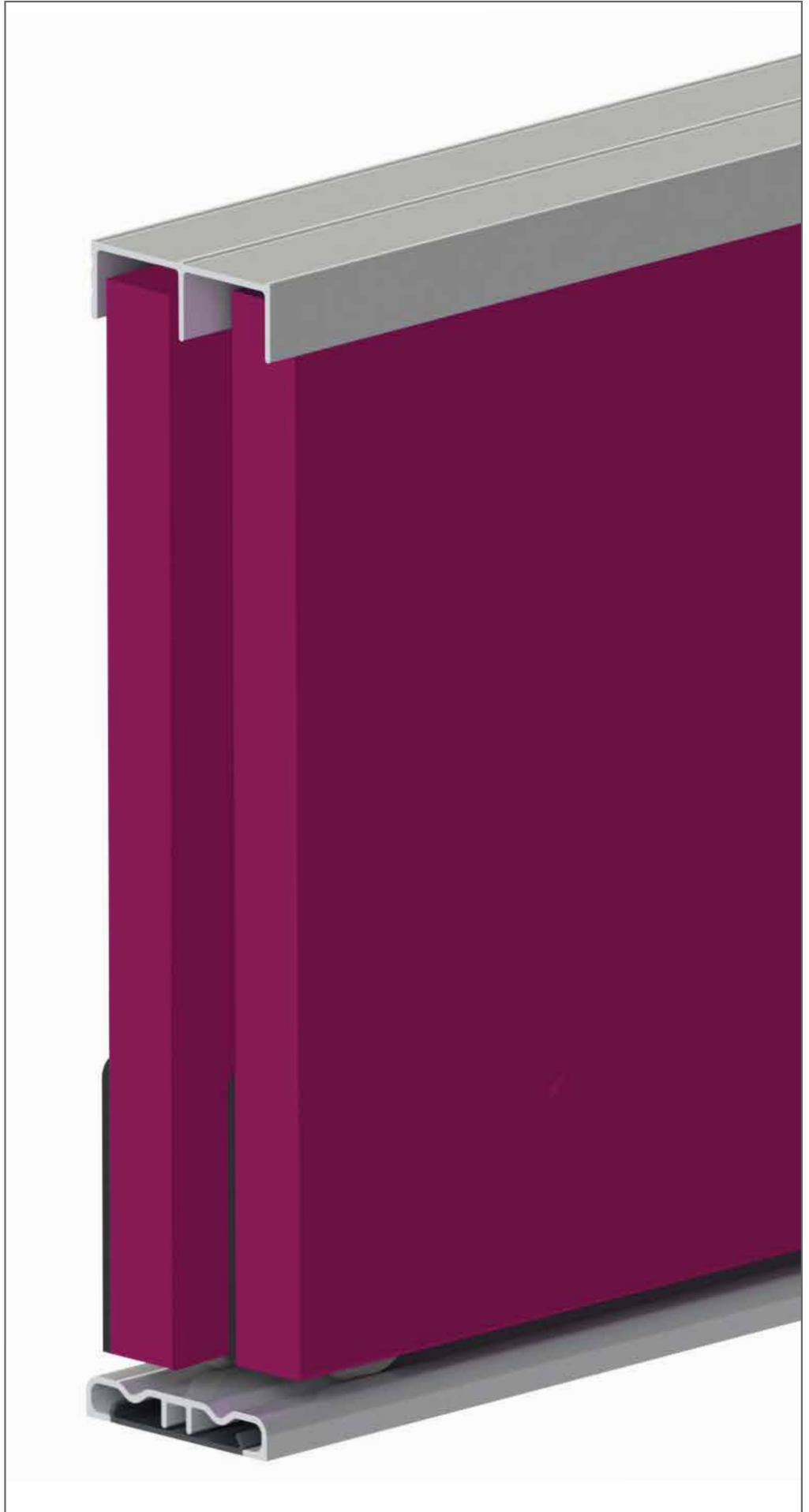

SLIDING CUPBOARD DOOR TRACK SYSTEM

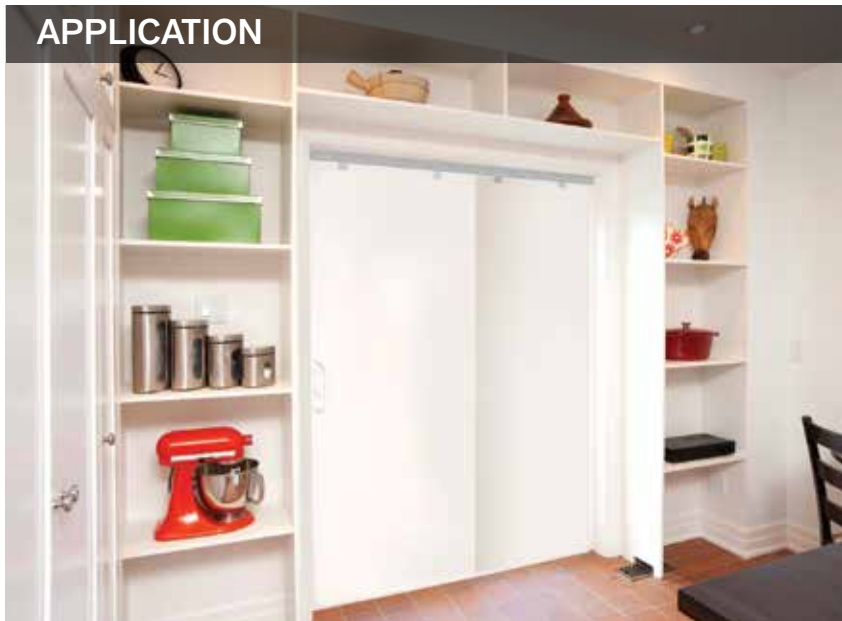

The Tudor is a sliding cupboard door track, designed with nylon wheels and lubricated ball bearings for quiet and smooth operation. The wheel assembly features a height adjustment slot for accurate door alignment and zinc plated steel components to help reduce corrosion.

FEATURES

- Nylon wheels with lubricated ball bearings - quiet and smooth
- Dual wheels on pivoting axle - 20kg per door max.
- Height adjustment slot for accurate door alignment
- Ribbed aluminium track for visual appeal
- Zinc plated steel components reduces corrosion

DETAILS

For 2 or more doors in bi-passing applications run the tracks parallel to each other. The door and/or track gap will be determined by the door thickness.

TECHNICAL SPECIFICATIONS

| | |
|------------------------|----------------|
| Suits: | Multiple doors |
| Door Thickness: | 16mm |

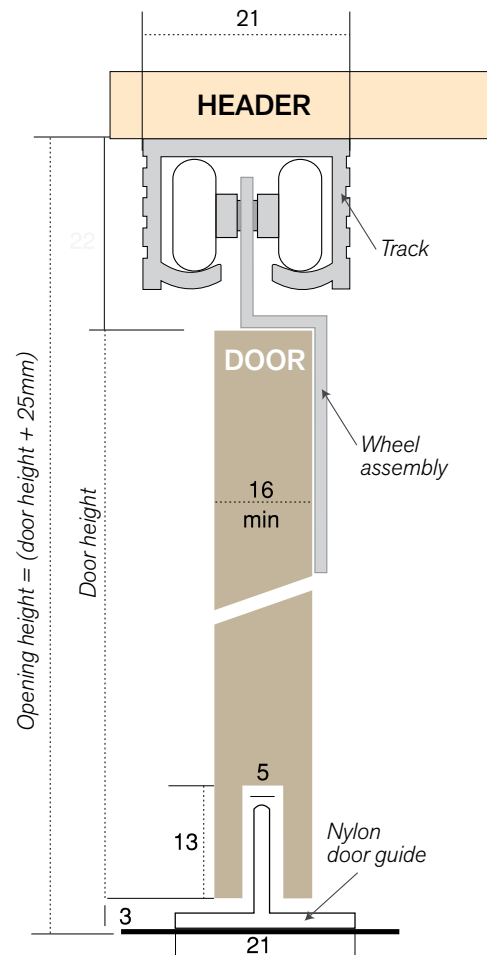
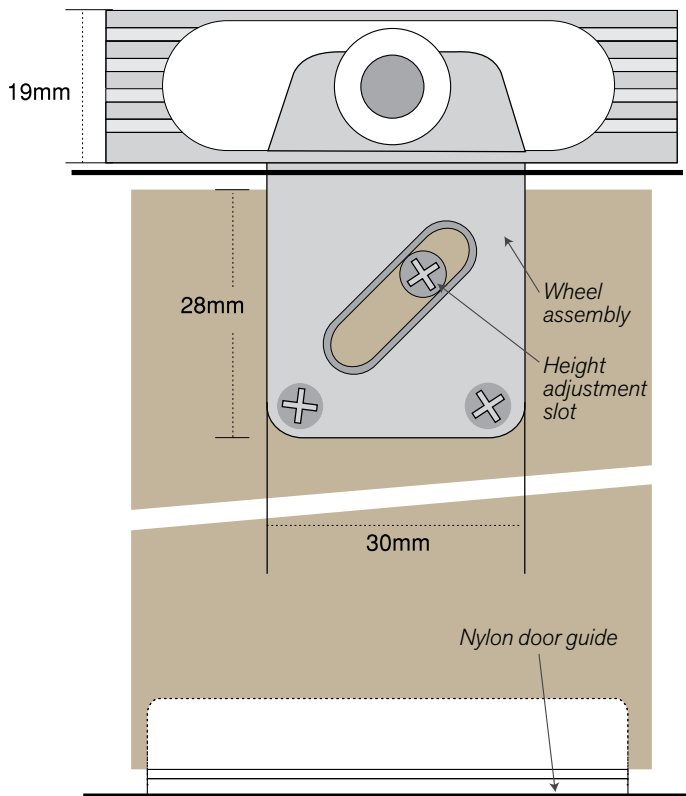

* Full product codes & options refer to **page 84**

COMPONENTS

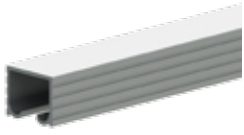

Aluminium track



Wheel assembly



Nylon door guide

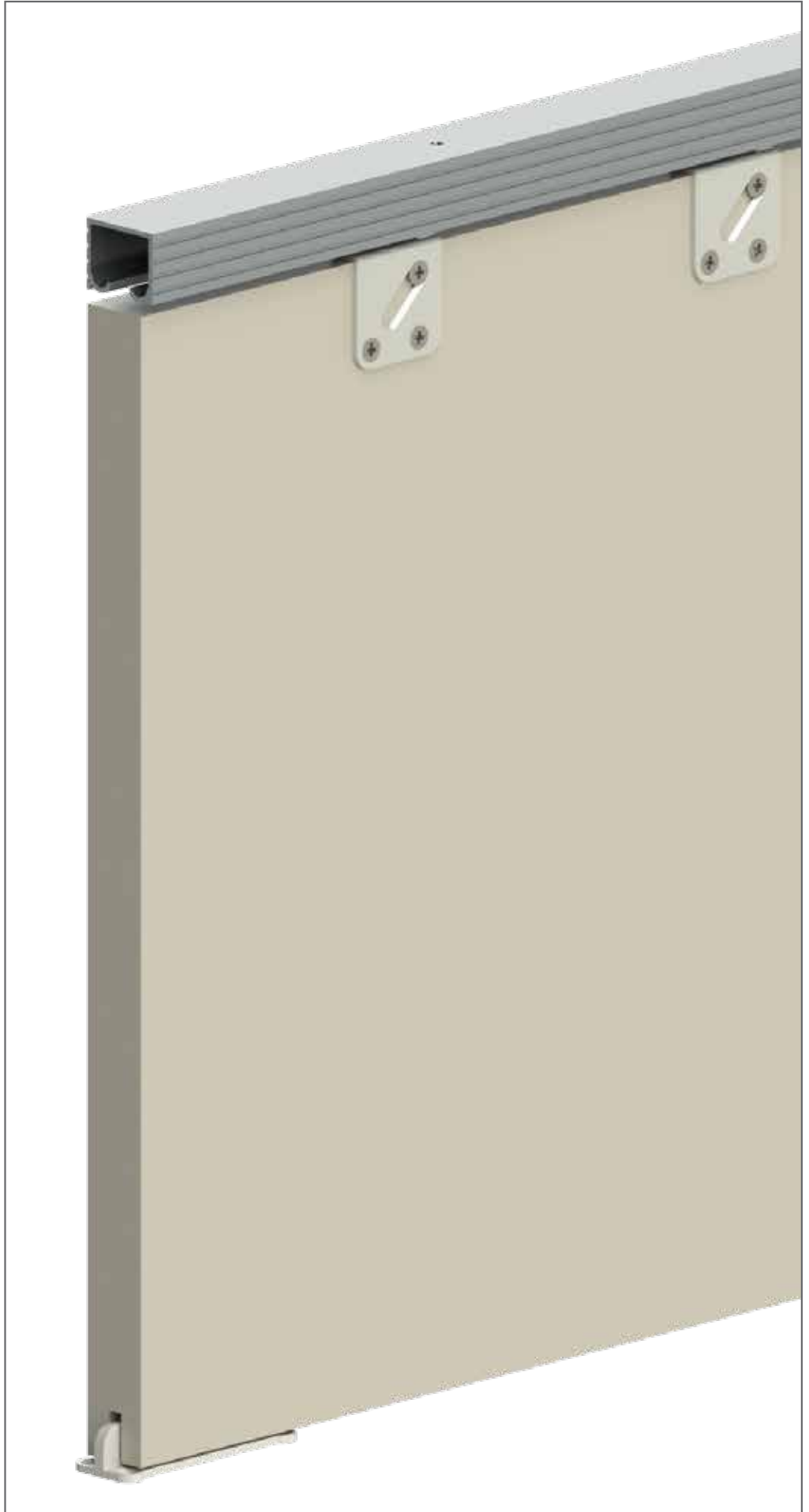

SLIDING WARDROBE AND CUPBOARD DOOR TRACK SYSTEM

APPLICATION



The Manhattan is a sliding wardrobe and cupboard door, capable of supporting 50kg per door. It features nylon wheels and lubricated ball bearings for quiet and smooth operation as well as a height adjustment slot for accurate door alignment.

FEATURES

- Nylon wheels rivetted to bracket with lubricated ball bearings for quiet and smooth running
- Height adjustment slot for accurate door alignment
- Extruded aluminium double "J" track - ribbed
- Anti-jump lip built into track
- Zinc plated steel components resist corrosion

DETAILS

TECHNICAL SPECIFICATIONS

Suits: Multiple doors
Door Thickness: 19 to 40mm

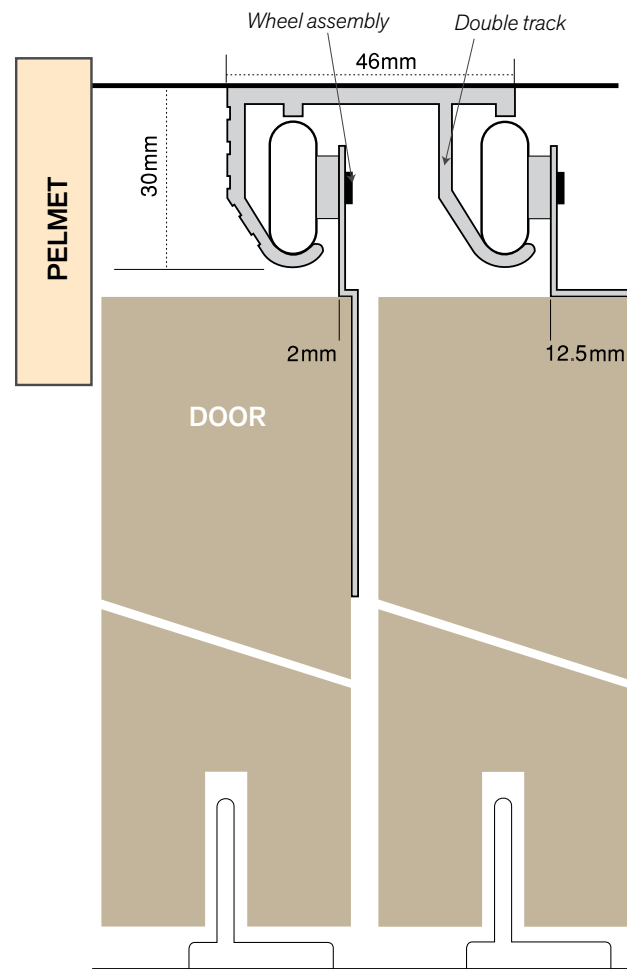
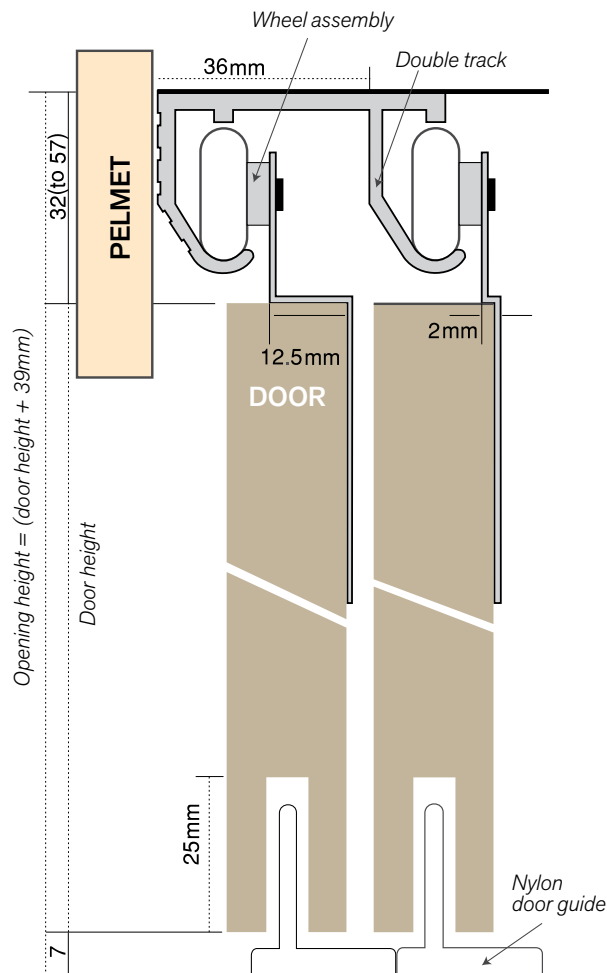

* Full product codes & options refer to **page 84**

COMPONENTS



Double track



Wheel assembly
2mm offset



Wheel assembly
12.5mm offset



Nylon door guide

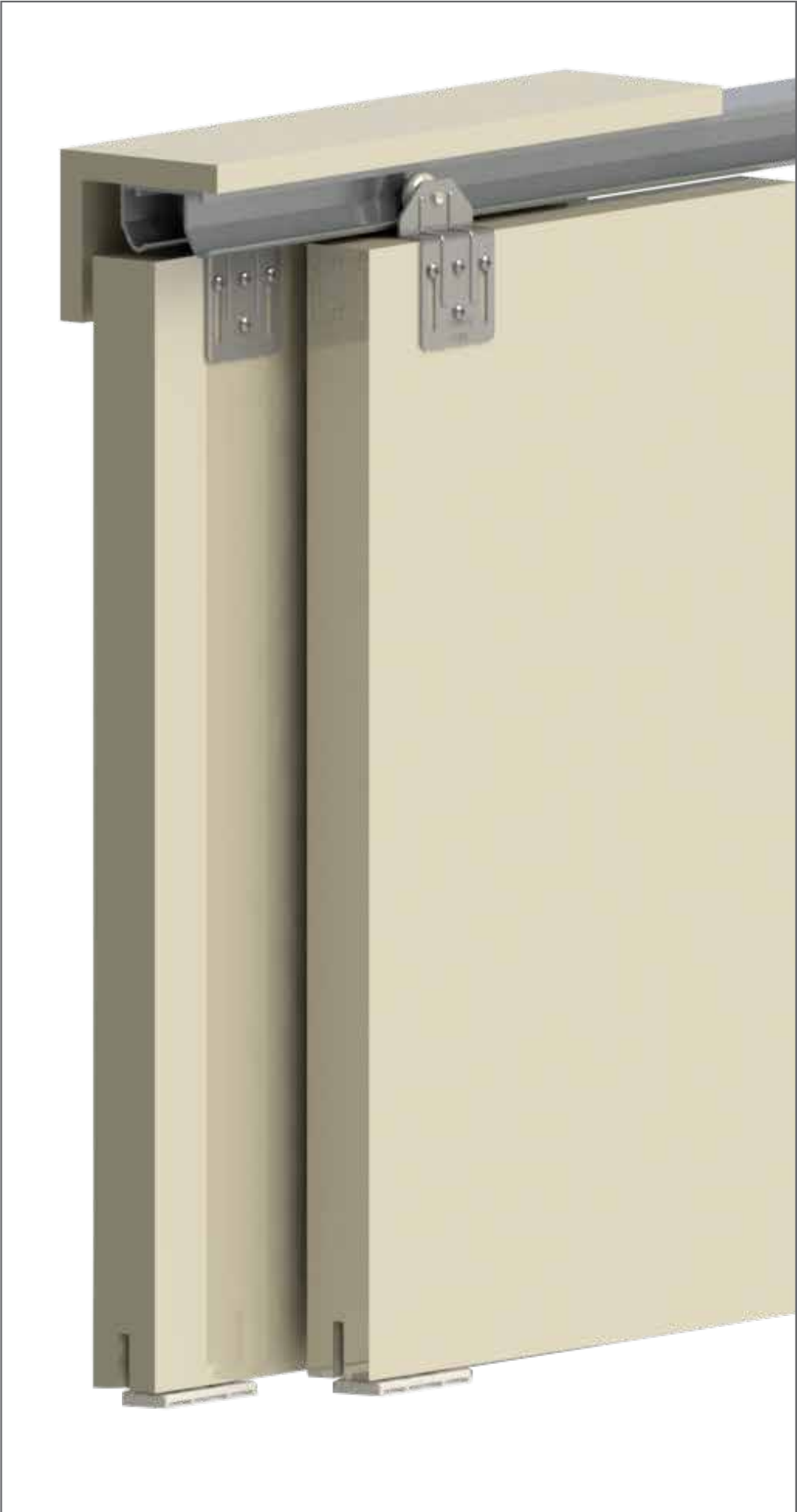

IDEAL FOR WARDROBE OPENINGS

This aluminium jamb channel has been developed to complement the popular “Robemaker” wardrobe door system but is also suitable for use with most bi-passing 2 door track systems.

The channel fits perfectly over the existing “Robemaker” extrusions and has matching aesthetics - a ribbed face on one side and a smooth plain face on the other.

It is available as a packaged set of 2 jambs at 2470mm long and is available pre-finished in gloss white. Packs come with fixing screws and screw caps.

Suitable for use with most bi-passing door track systems.

Packed set 2470mm

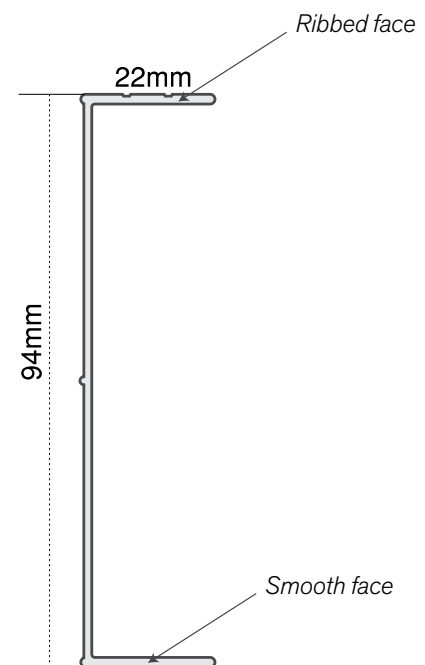
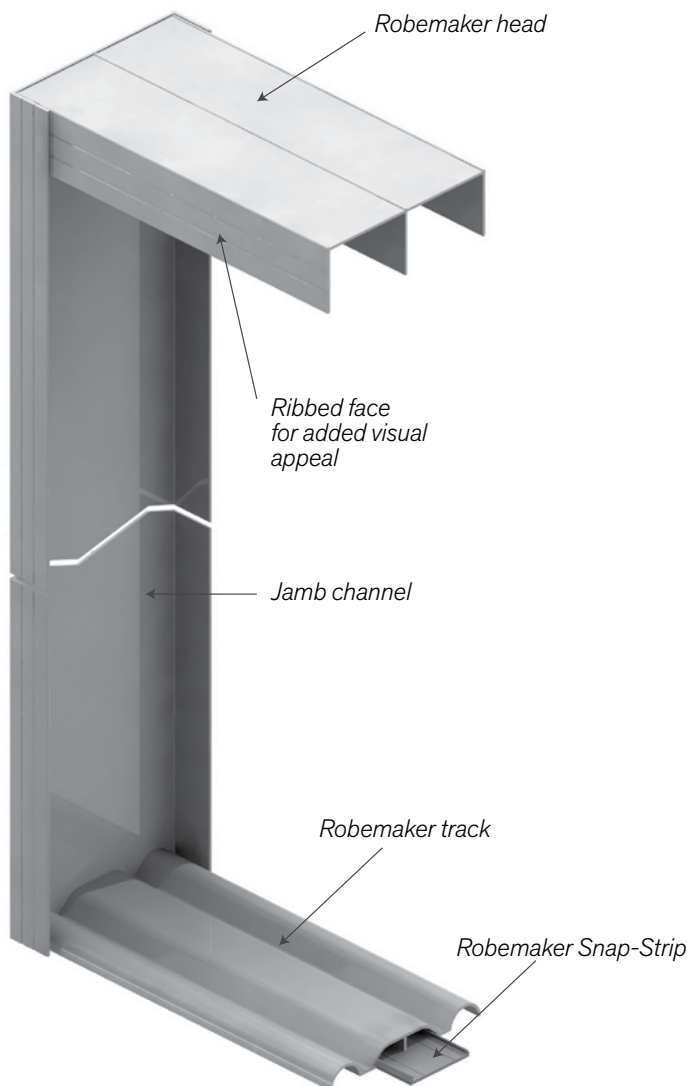



SLIDING CUPBOARD DOOR TRACK SYSTEM

APPLICATION



The Easy Roller can be fixed from beneath the sheave or can be fitted to a rebated sash with the screws through side of sheave. The Easy Roller is specifically designed for use with timber sashes and cupboard doors with a 12mm minium thickness.

FEATURES

- Multiple doors in bottom rolling application
- Acetal wheel for silent and smooth sliding
- Moulded nylon carrier block
- Track/head guide - extruded aluminium

DETAILS

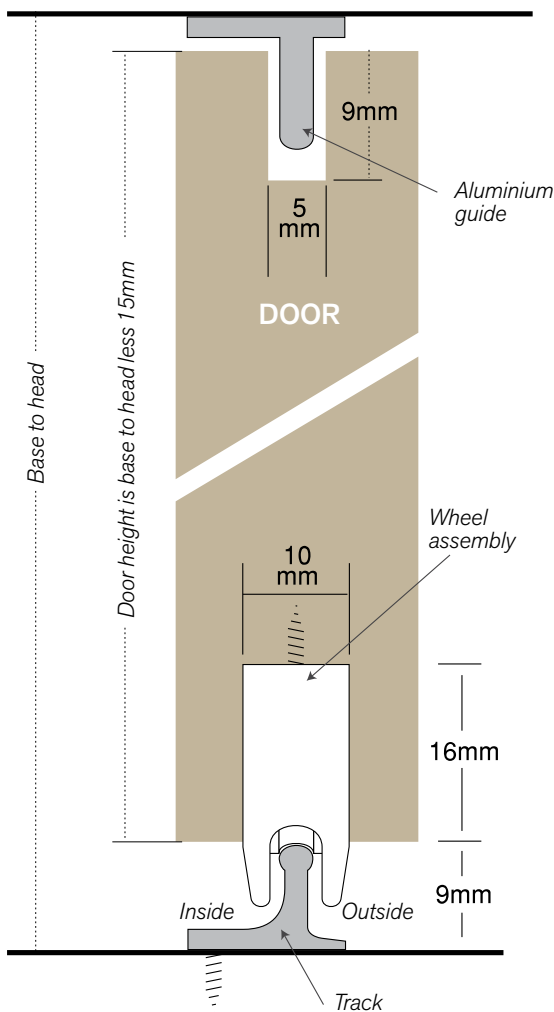

TECHNICAL SPECIFICATIONS

Suits: Multiple doors
Door Thickness: 12mm min

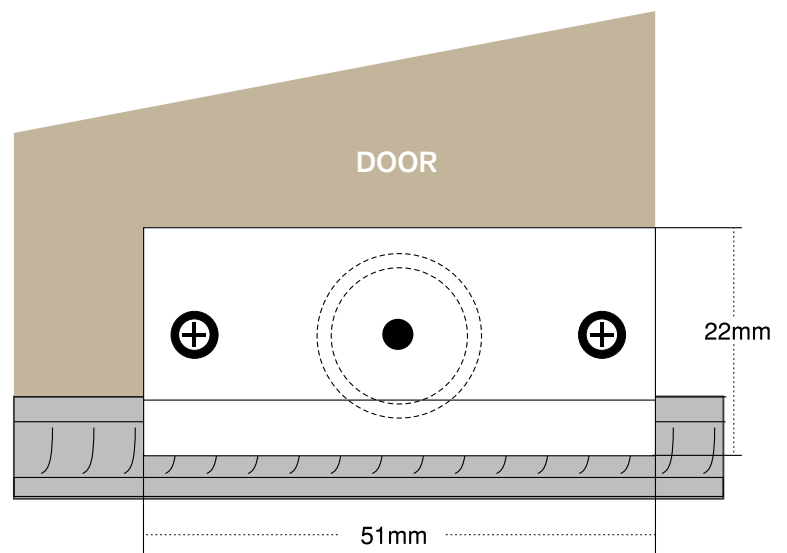

Where Bi-Passing doors are required, the door thickness determines the track spacing. Calculation of 16mm rebate allows for sheave to operate without having to rebate the full length of the door. That is, wheel sits below the bottom of the door.

* Full product codes & options refer to **page 84**

COMPONENTS

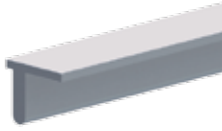

Aluminium guide

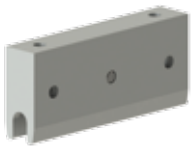

Wheel assembly

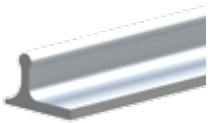

Aluminium track

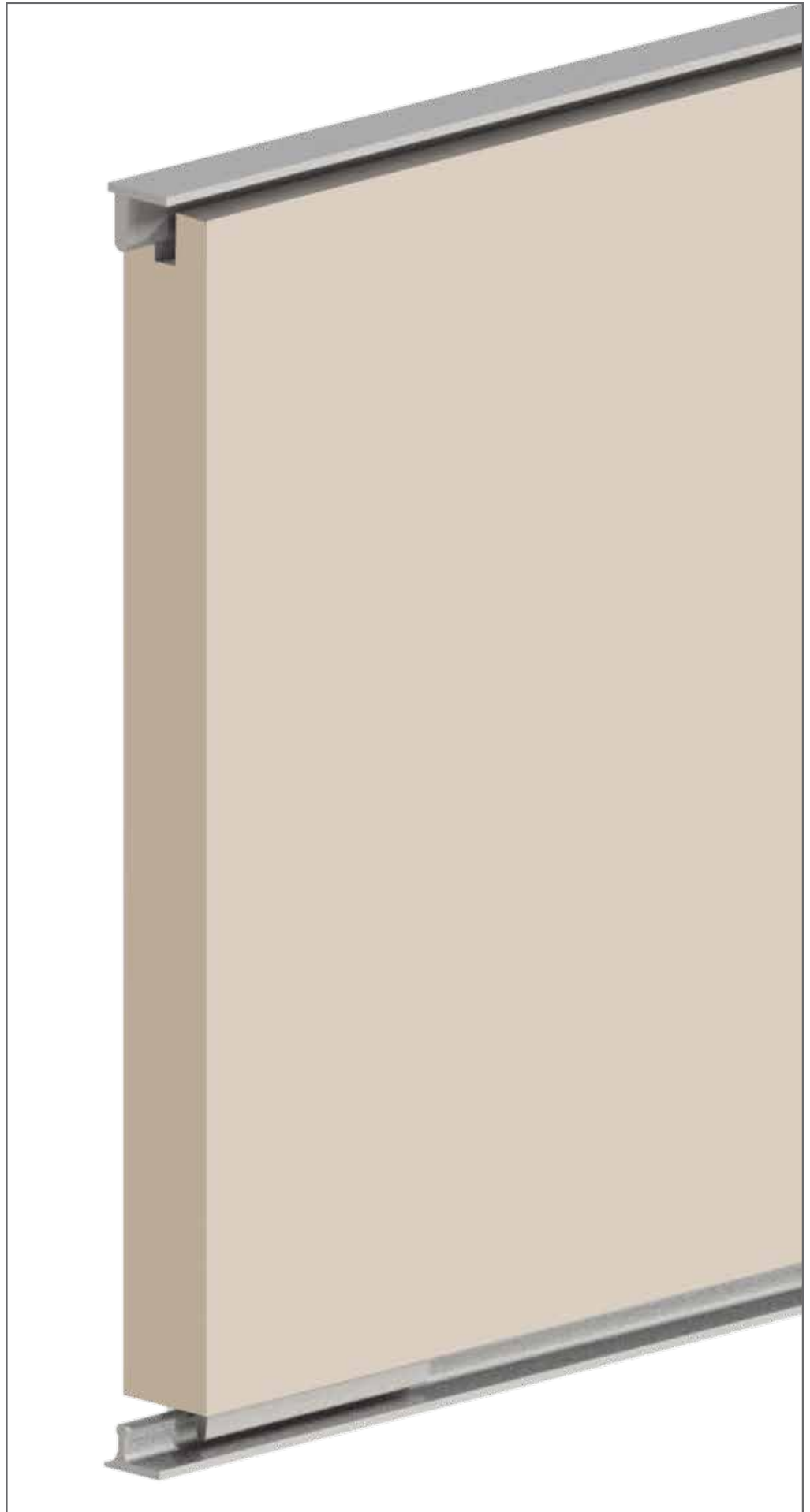

SLIDING CUPBOARD DOOR TRACK SYSTEM

APPLICATION



The Jiffy Adjuster is a sliding cupboard door designed for use with timber sashes and cupboard doors that are 12mm or thicker. The door features acetal wheel for silent and smooth operation and allows for multiple doors bottom rolling.

FEATURES

- Multiple doors in bottom rolling application
- Designed for use with timber sashes and cupboard doors - 12mm or more thick
- Acetal wheel for silent and smooth rolling
- Moulded nylon 2-part carrier block with 4mm height adjustment
- Aluminium track and head guide

DETAILS

TECHNICAL SPECIFICATIONS

Suits: Multiple doors
Door Thickness: 12mm min

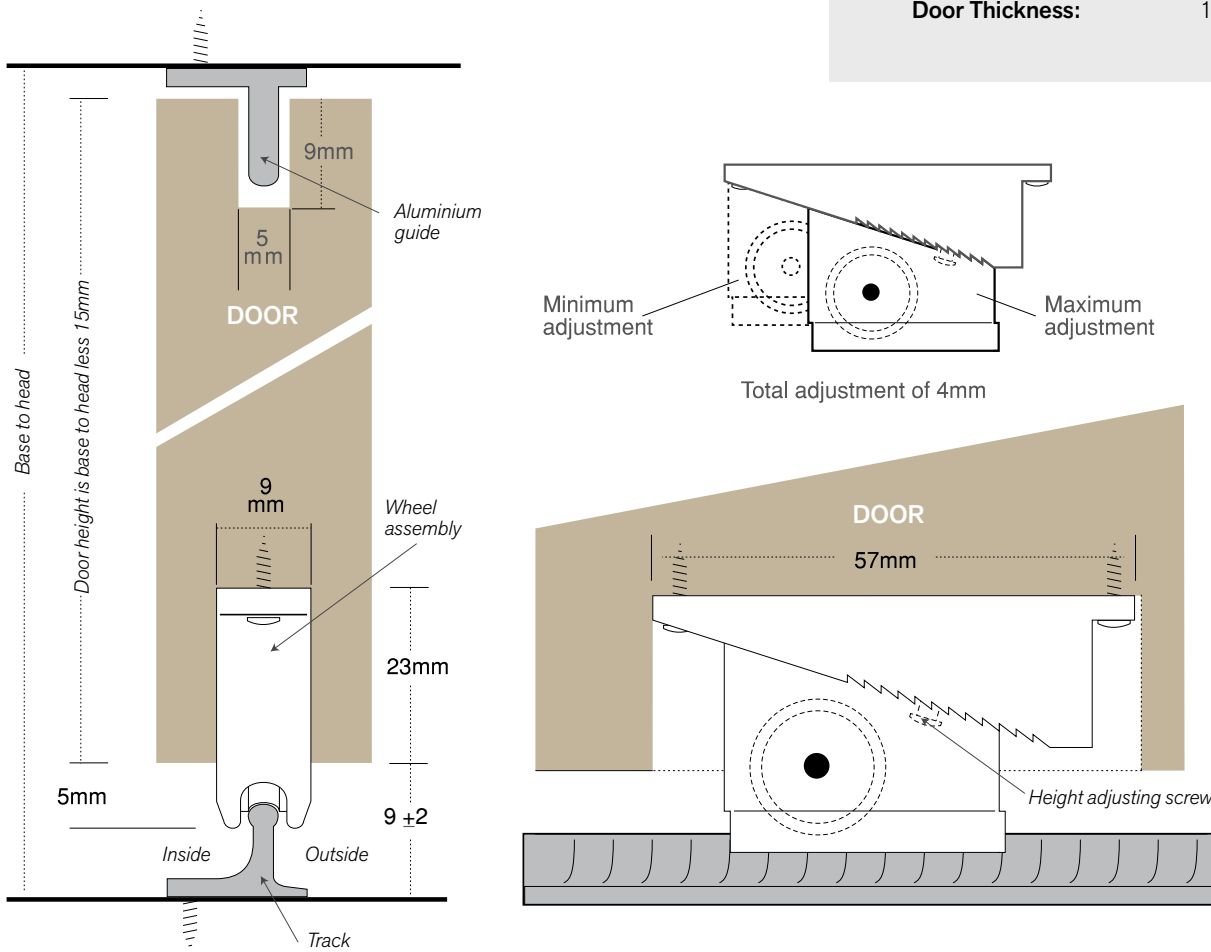

Calculation of 23mm rebate allows for sheave to operate without having to rebate the full length of the door. That is, wheel sits below the bottom of the door.

* Full product codes & options refer to **page 84**

COMPONENTS

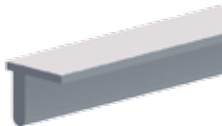

Aluminium guide



Wheel assembly

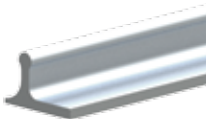

Aluminium track

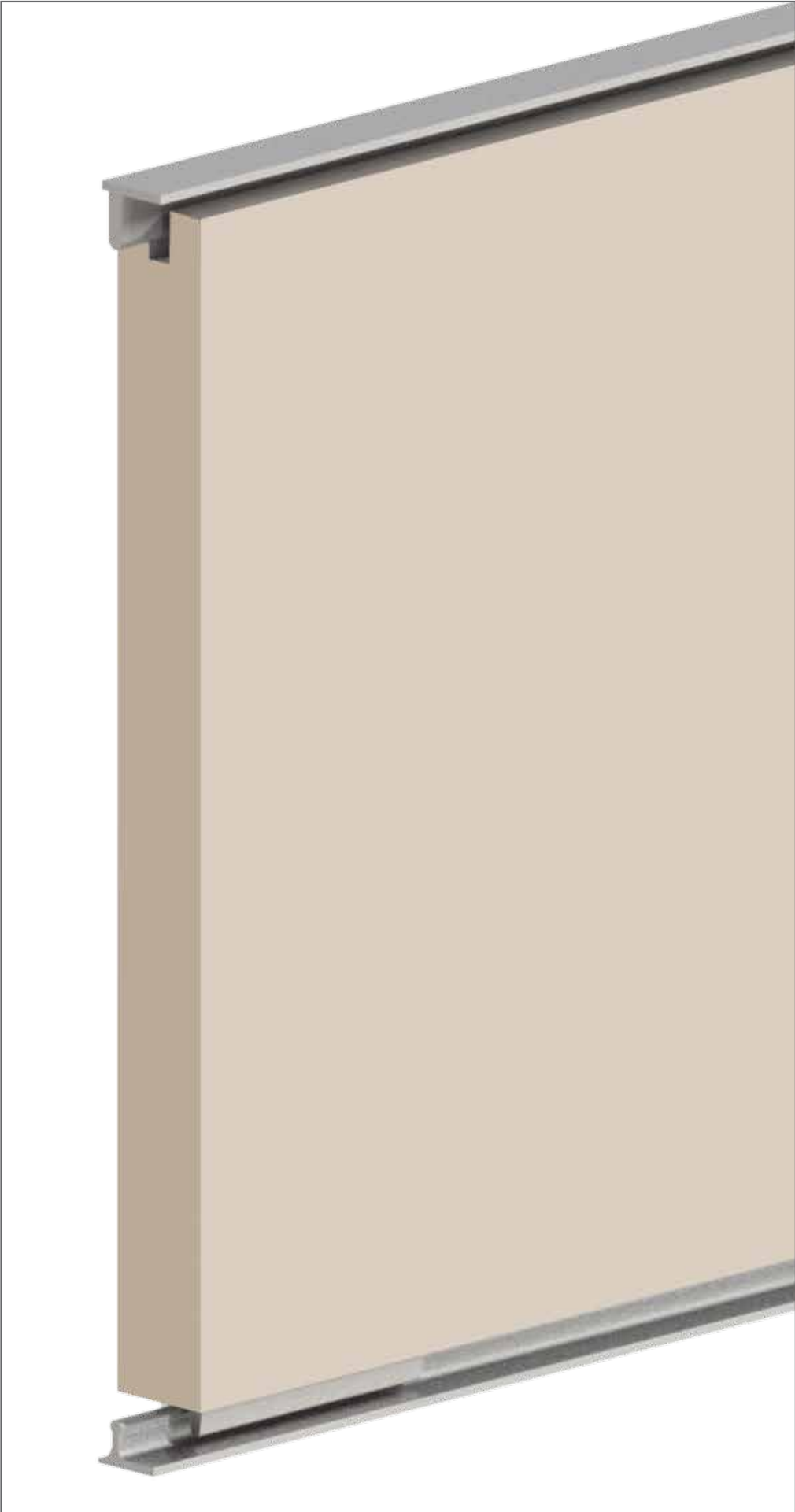

SLIDING CUPBOARD DOOR TRACK SYSTEM



The Horizon is a mid-weight system for bottom rolling doors. The system is designed for use with light to medium timber or glass sliding doors and includes an optional head guide block for noise reduction.

FEATURES

- Head guide - extruded aluminium
- Designed for use with light to medium timber or timber/glass sliding doors
- Optional head guide block - for noise reduction
- Option of brass, bronze or aluminium track

DETAILS

TECHNICAL SPECIFICATIONS

Suits: Multiple doors
Door Thickness: 29mm min

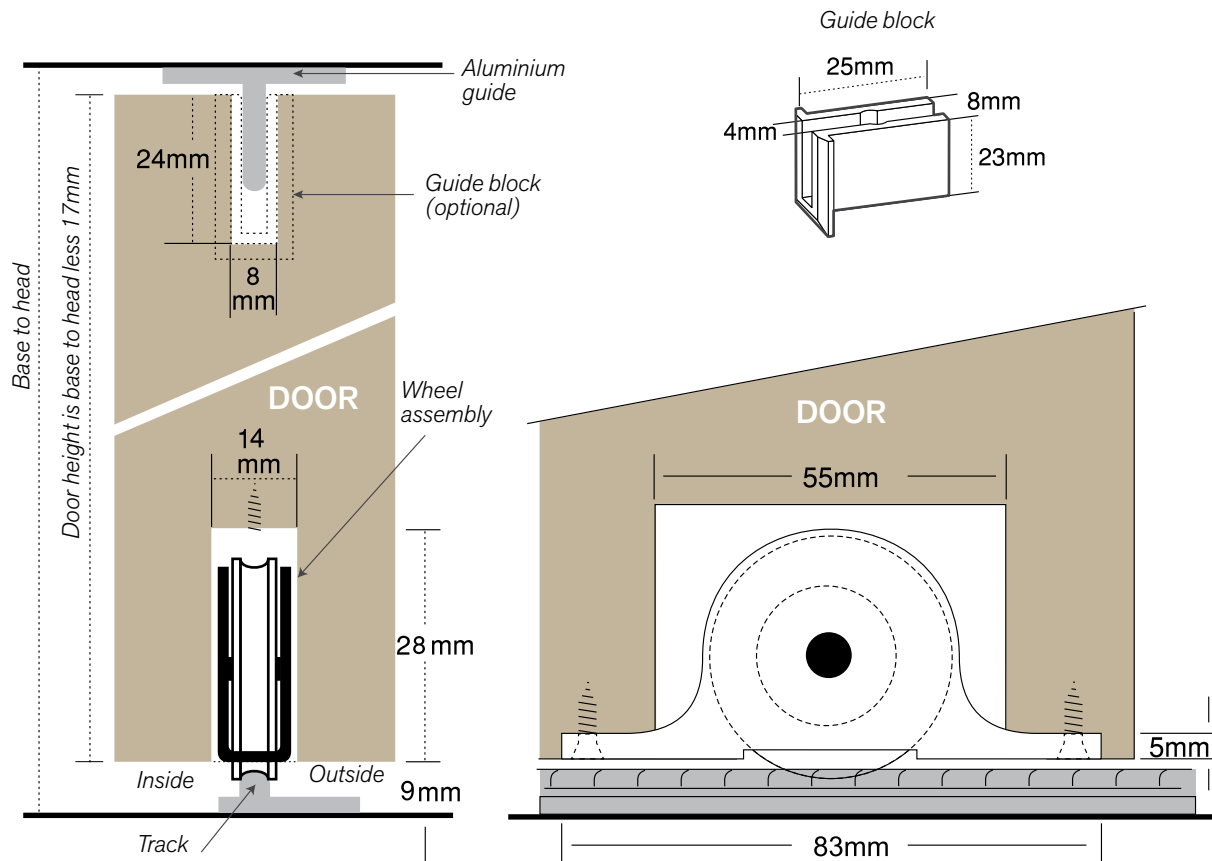

Where Bi-Passing doors are required, the door thickness determines the track spacing.

Minimum door thickness 29mm

* Full product codes & options refer to **page 85**

COMPONENTS



Bronze track



Brass track



Aluminium track



Wheel assembly
with nylon wheel
(60kg per door)



Wheel assembly
with steel wheel

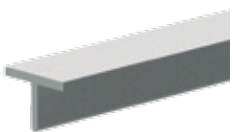

Aluminium guide

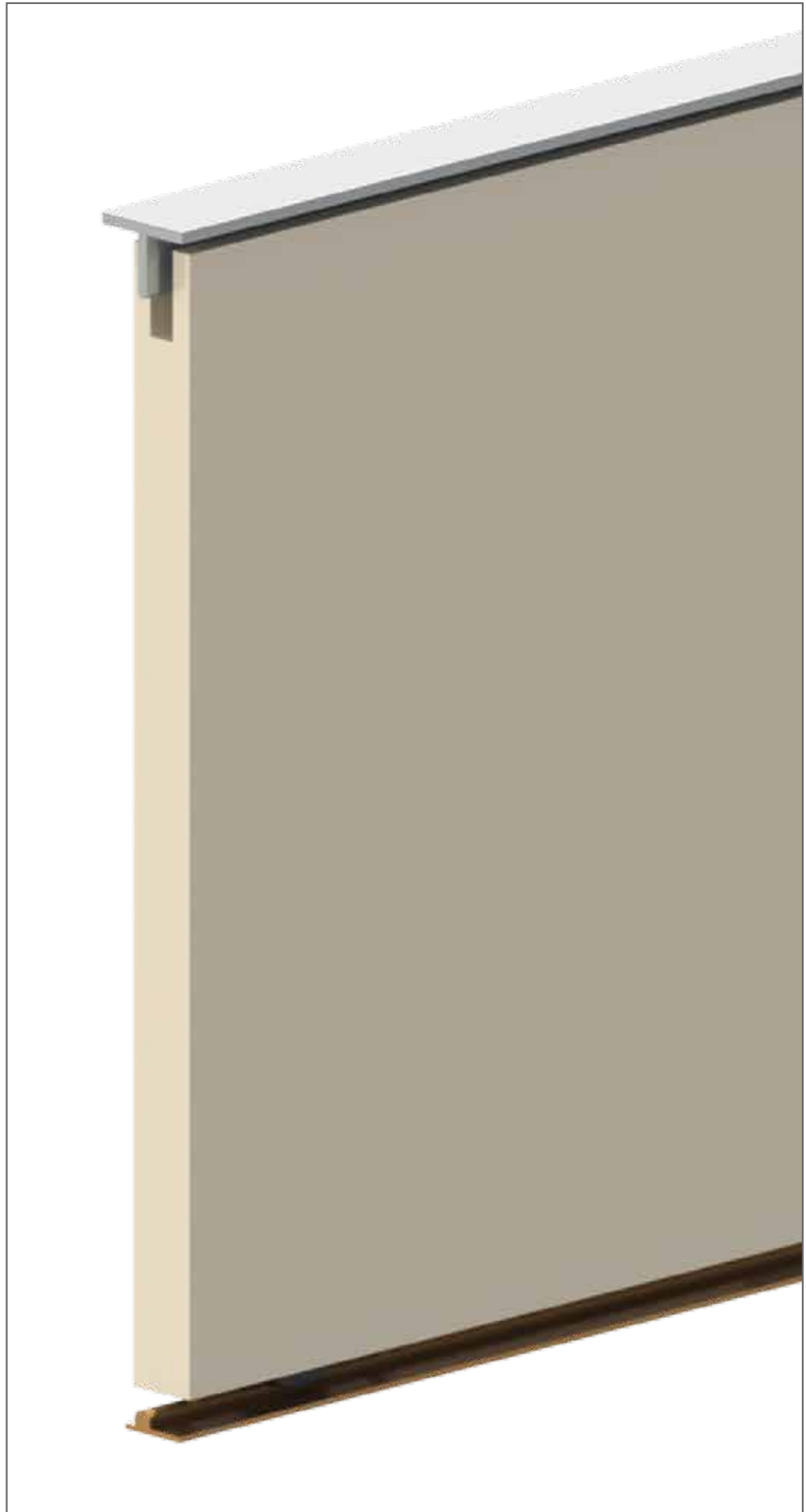

SLIDING DOOR TRACK SYSTEMS



The Timberline features manganese bronze tyre and 316 stainless steel housing with an optional head guide block for noise reduction. The Timberline is suitable for external use, particularly patio doors and other heavy duty applications.

FEATURES

- Multiple doors in bottom rolling application
- Suitable for external use - especially suited to patio doors
- Manganese bronze track
- Optional head guide block - for noise reduction
- Alternative pelmet guide and pelmet guide block to aid with weatherproofing

DETAILS

Top groove joinery detail using Pelmet Guide and Pelmet Guide Block - 24mm D x 8mm T

Top groove joinery detail using Guide and Guide block - 24mm D x 8mm T

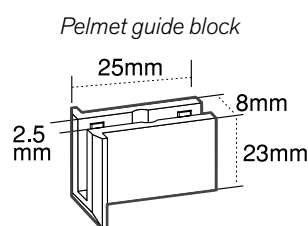
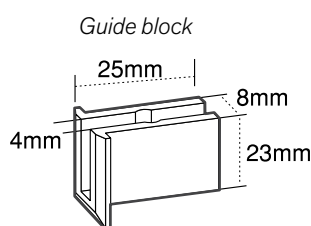
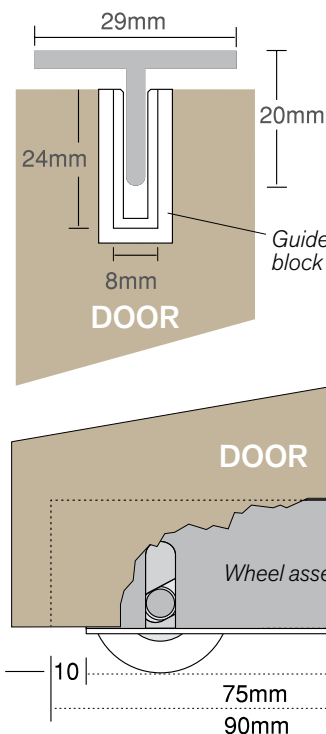
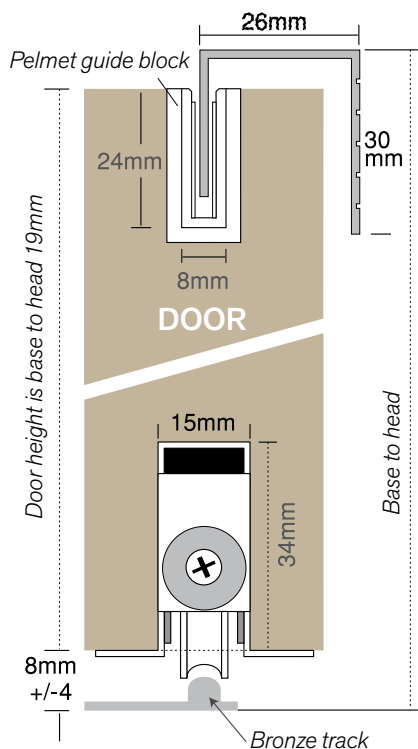

TECHNICAL SPECIFICATIONS

Suits: Multiple doors
Door Thickness: 35mm min

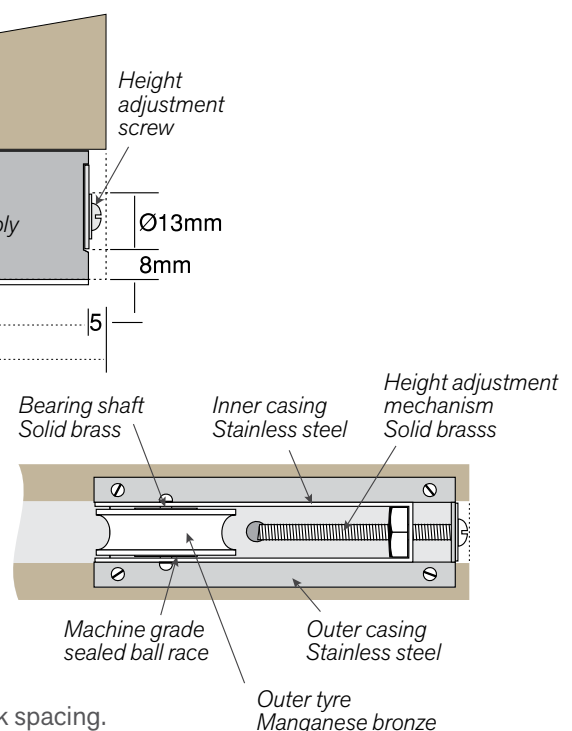

Where Bi-Passing doors are required, the door thickness determines the track spacing.

* Full product codes & options refer to **page 85**

COMPONENTS

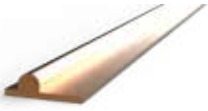

Bronze track



Brass track



Wheel assembly

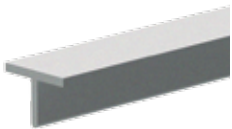

Aluminium guide



Nylon guide block

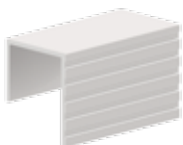

Aluminium
pelmet guide

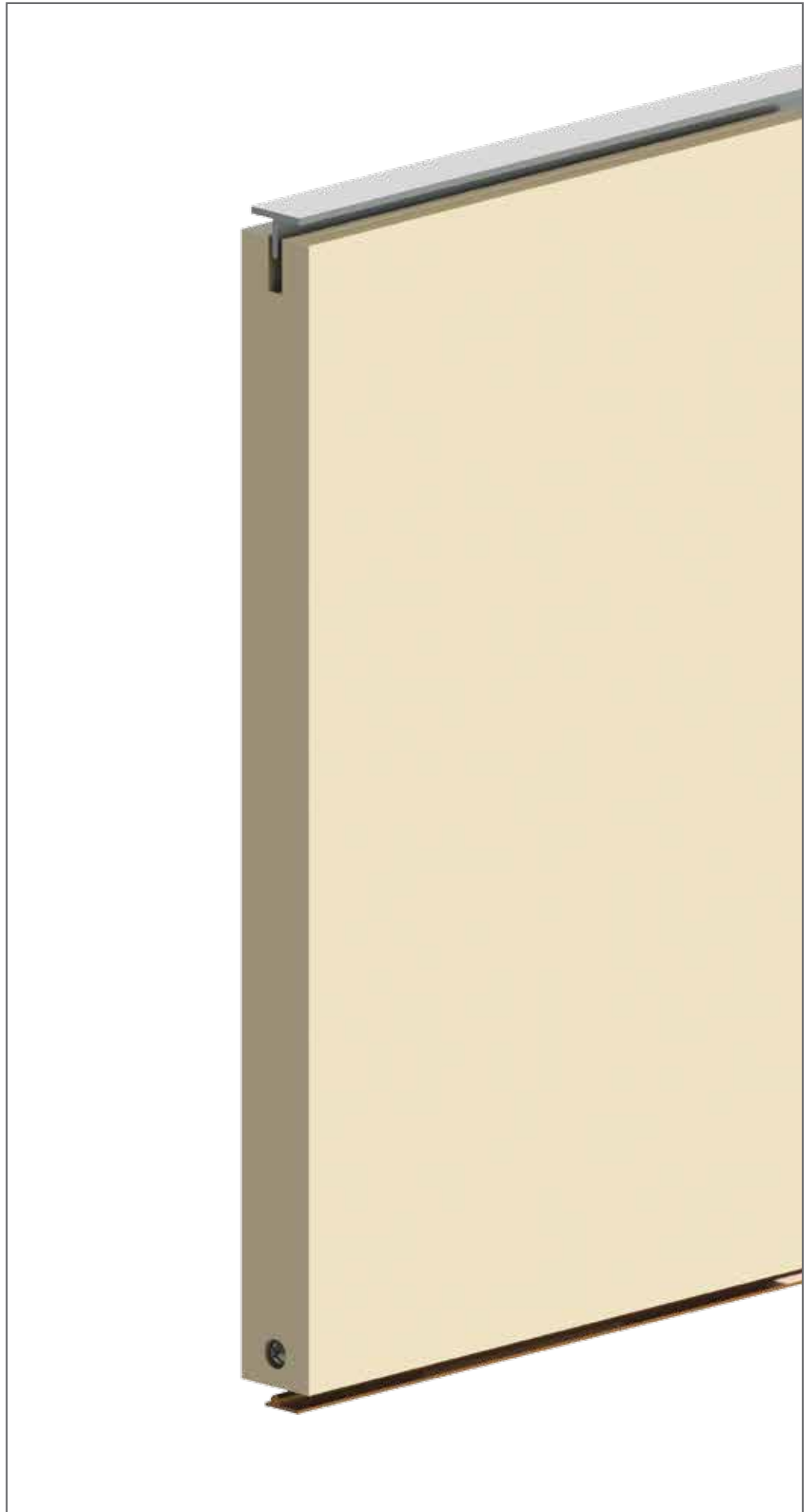

SLIDING DOOR TRACK SYSTEMS

APPLICATION



The Maxi Roller is a sliding door track system, designed for use with heavy timber doors or framed glass doors. The system can support a maximum capacity of 227kg per door and is suitable for external use.

FEATURES

- Multiple doors in bottom rolling application
- Roller - manganese bronze tyre and 316 stainless steel housing
- Track - manganese bronze for greater weight carrying
- Designed for use with heavy timber doors or framed glass doors
- Optional head guide block - for noise reduction
- Suitable for external use

DETAILS

TECHNICAL SPECIFICATIONS

| | |
|------------------------|----------------|
| Suits: | Multiple doors |
| Door Thickness: | 29mm min |

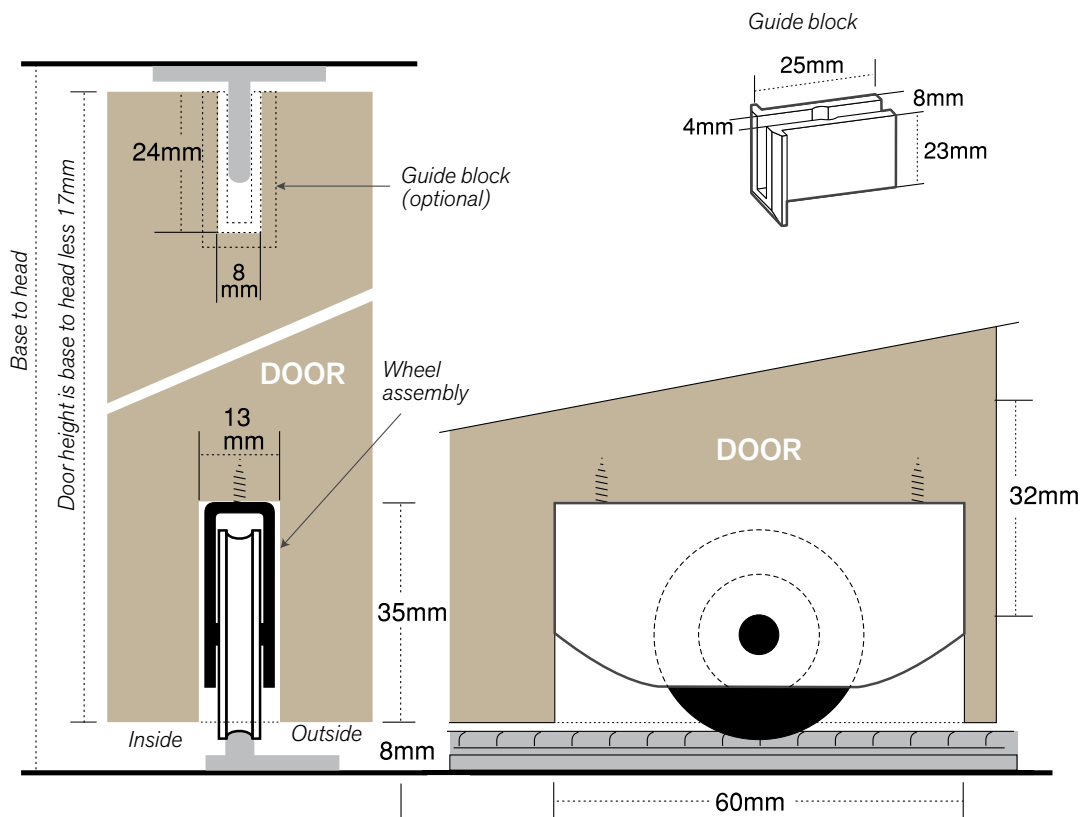

Where Bi-Passing doors are required, the door thickness determines the track spacing.

* Full product codes & options refer to **page 85**

COMPONENTS

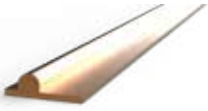

Bronze track



Brass track



Wheel assembly

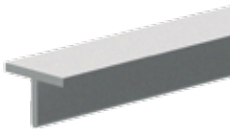

Aluminium guide



Nylon guide block

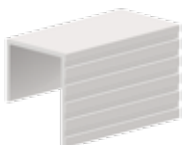

Aluminium
pelmet guide

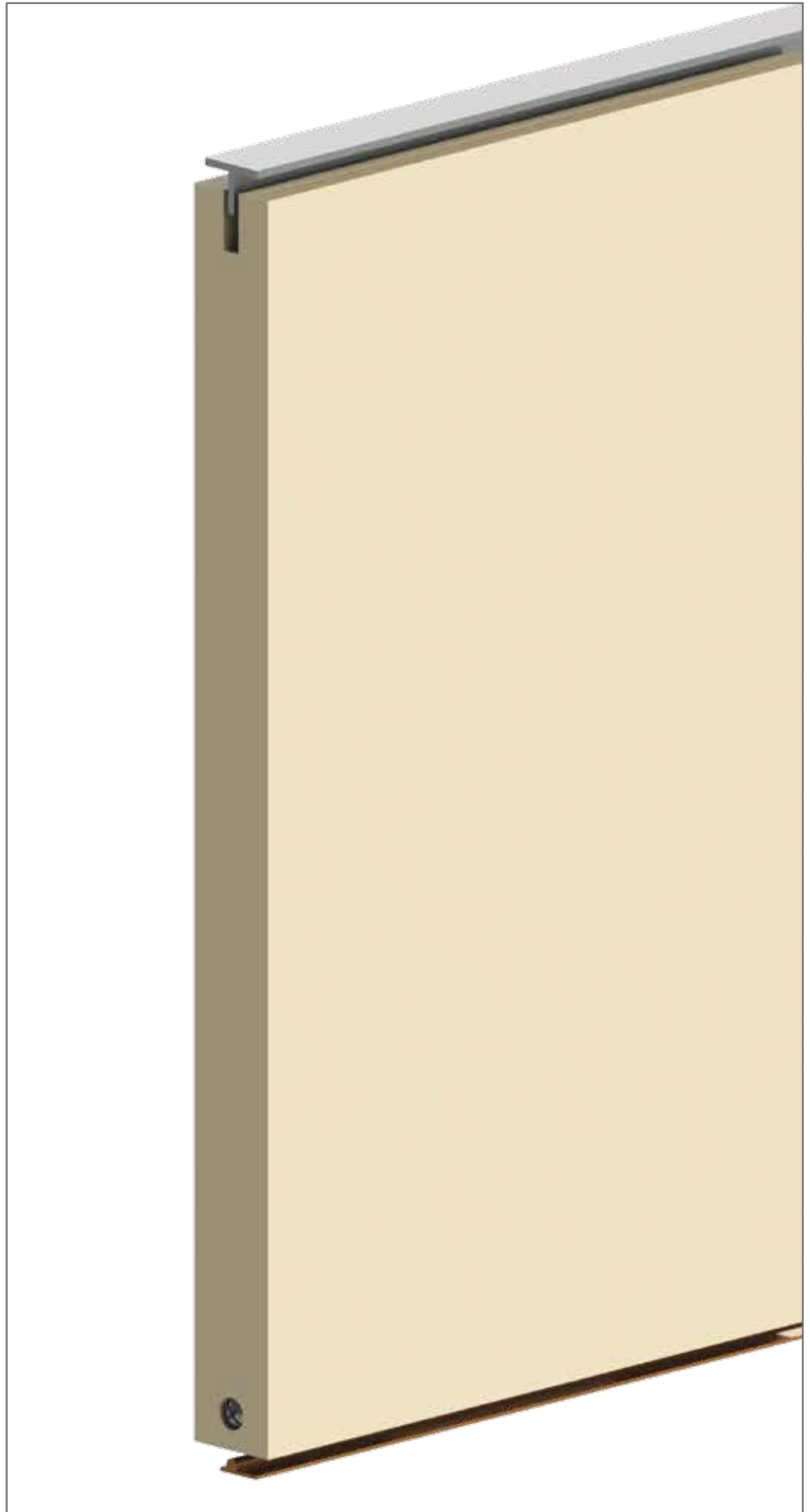

OPTIONAL EXTRA

APPLICATION



The Triumph Soft-Close Adaptors are able to be retro-fitted into pre-existing Triumph Sliding Door Track Systems. They are an excellent addition to your sliding door track system, slowing your doors to almost a halt and then pulled closed to complete a smooth, silent and soft-closing operation.

INCLUDES:

- Side fix catch mounts x 2
- Catch mount screws x 6
- Locating jig

DETAILS

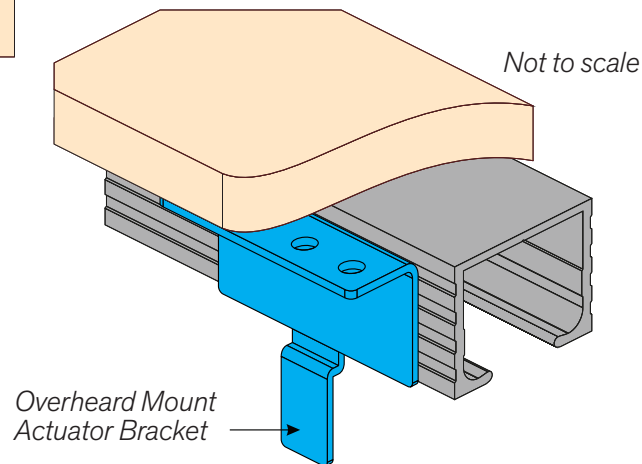
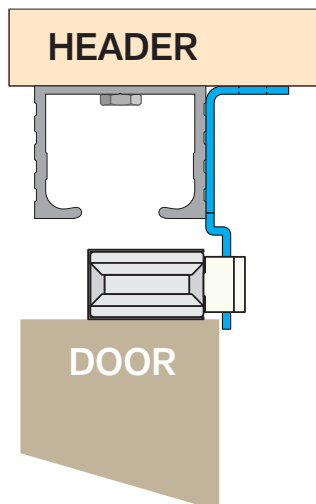
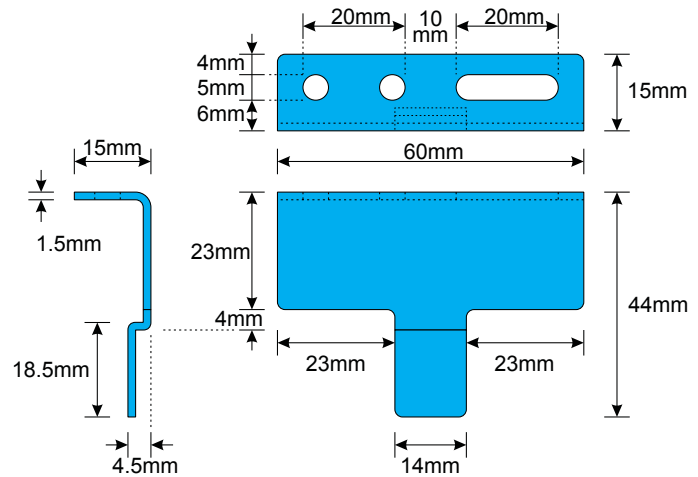

OPTIONAL EXTRA

APPLICATION



The box pair of soft-closing dampeners and catches which integrate seamlessly into the Robemaker system. The dampeners fit concealed in the top track while the catches locate unobtrusively to the top of the door. When the doors are closed their travel is slowed to almost a halt and then pulled closed to complete a smooth, silent and soft-closing operation.

INCLUDES:

- Side fix catch mounts x 2
- Catch mount screws x 6
- Locating jig

DETAILS

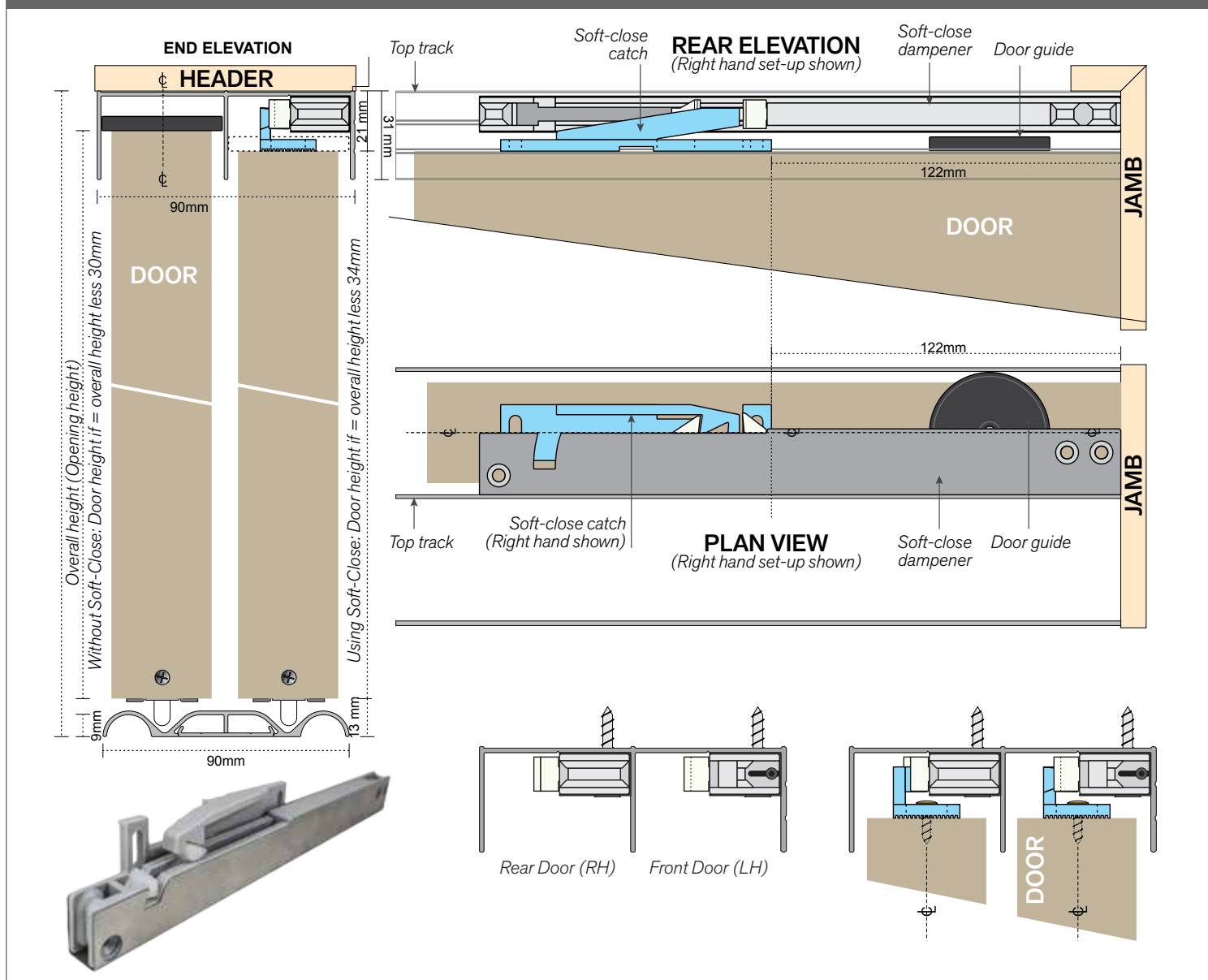

| TYPE | CODE | DESCRIPTION | SIZE | COLOUR | PAGE NO. |
|---|---------|--|--------|----------------|--------------|
| ARROW (35kg per door) | | | | | 20 |
| Pack/Set | P68000 | Packaged Set for Single Door | 915mm | - | |
| | TR68010 | Set for Single Door Trade Box of 15 | 915mm | - | |
| Replacement | TT68200 | Race Assembly with Anti-Lift Bracket | - | - | |
| | S20800 | Standard Duty Door Guide Pack | - | - | |
| | S64900 | General Purpose Door Stop Pack | - | - | |
| | S68100 | Wheels with Axle & Nut Pack | - | - | |
| | P67710 | Aluminium Pelmet Set | 1830mm | White | |
| Optional | P67720 | Aluminium Pelmet Set | 3660mm | White | |
| | TT34600 | Adjustment Spanner 8 & 10 mm | - | - | |
| GENTURION (HEAVY DUTY ARROW) (60kg per door) | | | | | 22 |
| Pack/Set | P10010 | Packaged Set for Single Door | 915mm | - | |
| | P10020 | Packaged Set for Single Door | 1220mm | - | |
| Replacement | S10400 | Wheels with Axle & Nut Pack | - | - | |
| | S20800 | Standard Duty Door Guide Pack | - | - | |
| | S64900 | General Purpose Door Stop Pack | - | - | |
| Optional | P67710 | Aluminium Pelmet Set | 1830mm | White | |
| | P67720 | Aluminium Pelmet Set | 3660mm | White | |
| QUAD BALL (50kg per door) | | | | | 24 |
| Pack/Set | P75020 | Packaged Set for Single Door | 920mm | Mill | |
| | P75500 | Quad Ball Carrier Assembly Pack | - | - | |
| Replacement | P75600 | Quad Ball Nylon Door Stop Pack | - | - | |
| | S20800 | Standard Duty Door Guide Pack | - | - | |
| Optional | P67710 | Aluminium Pelmet Set | 1830mm | White | |
| | P67720 | Aluminium Pelmet Set | 3660mm | White | |
| FORERUNNER & FORERUNNER PELMET (50kg per door) | | | | | 26-29 |
| Pack/Set | P14010 | Packaged Set for Single Door Top Mount | 915mm | Mill | |
| | P14310 | Packaged Set for Single Door Wall Mount | 915mm | Mill | |
| | P16010 | Packaged Set for Single Door Wall Mount Pelmet | 915mm | Mill | |
| | P16016 | Packaged Set for Single Door Wall Mount Pelmet | 915mm | White | |
| | P16020 | Packaged Set for Single Door Wall Mount Pelmet | 1220mm | Mill | |
| | P16026 | Packaged Set for Single Door Wall Mount Pelmet | 1220mm | White | |
| Replacement | S20800 | Standard Duty Door Guide Pack | - | - | |
| | S33100 | Wheel Assemblies Pack | - | - | |
| Optional | TT32500 | Door Side Fix Bracket | - | - | |
| | TT34600 | Adjustment Spanner 8 & 10 mm | - | - | |
| TRIUMPH SLIDING (80kg per door) | | | | | 30 |
| Pack/Set | P30010 | Packaged Set for Single Door Wall Mount | 915mm | Clear Anodised | |
| | P30510 | Packaged Set for Single Door Top Mount | 915mm | Clear Anodised | |
| | P31500 | Components Pack for Single Door | - | - | |
| Components & Replacement | TT32011 | Top Mount Track | 2000mm | Mill | |
| | TT32021 | Top Mount Track | 2500mm | Mill | |
| | TT32031 | Top Mount Track | 3400mm | Mill | |
| | TT32041 | Top Mount Track | 4500mm | Mill | |
| | TT32072 | Top Mount Track | 5560mm | Clear Anodised | |
| | TT32311 | Wall Mount Track | 2000mm | Mill | |
| | TT32321 | Wall Mount Track | 2500mm | Mill | |
| | TT32331 | Wall Mount Track | 3400mm | Mill | |
| | TT32341 | Wall Mount Track | 4500mm | Mill | |
| | TT32372 | Wall Mount Track | 5560mm | Clear Anodised | |
| | S33700 | Quick Release Wheel Assembly (Pack of 2) | - | - | |
| | TT32600 | Concealed Door Stop Assembly | - | - | |
| | S20800 | Standard Duty Door Guide Pack | - | - | |
| Optional | TT32100 | Door Stop Bracket | - | - | |
| | TT37500 | Door Stop | - | - | |

| TYPE | CODE | DESCRIPTION | SIZE | COLOUR | PAGE NO. | | |
|---|---|--|--------------------------------|----------------|-----------|-----------|--|
| Optional | P67710 | Aluminium Pelmet Set | 1830mm | White | | | |
| | P67720 | Aluminium Pelmet Set | 3660mm | White | | | |
| | TT33800 | Quick Release Door Side Fix Bracket | - | - | | | |
| | TT34600 | Adjustment Spanner 8 & 10 mm | - | - | | | |
| | TT35700 | Soft Close Actuator Bracket for Triumph | - | - | | | |
| | TT59800 | Soft Close Box Pack for 2 Doors | - | - | | | |
| EXPOSED 90 (90kg per door) | | | | | 32 | | |
| Pack/Set | TT26020 | Packaged Box Set for Single Door Top Mount | 1220mm | Stainless | | | |
| | TT26028 | Packaged Box Set for Single Door Top Mount | 1220mm | Black | | | |
| Optional | TT268SS | Track Joiner with Screws | - | Stainless | | | |
| TROJAN (120kg per door) | | | | | 34 | | |
| Pack/Set | P53030 | Packaged Set for Single Door Top Mount | 1500mm | Mill | | | |
| | P53100 | Components Pack for a Single Door | - | - | | | |
| Components & Replacement | TT21600 | Aluminium Heavy Duty Guide | 150mm | Mill | | | |
| | TT53011 | Aluminium Track | 4500mm | Mill | | | |
| | TT53061 | Aluminium Track | 6000mm | Mill | | | |
| Optional | AW82200 | Track Wall Mount Bracket | - | Stainless | | | |
| | P54000 | Glass Door Components Pack (80kg) | - | - | | | |
| | TT52500 | Door Side Fix Bracket | - | - | | | |
| ALLWEATHER SLIDING (240kg per door) | | | | | 36 | | |
| Components & Replacement | AW21600 | Roller Guide | - | Stainless | | | |
| | AW80600 | Perimeter Seal Q-48 Suits Gaps 2 - 3mm | - | Black | | | |
| | AW80800 | Perimeter Seal Q-21 Suits Gaps 5-7.5mm | - | Black | | | |
| | AW81200 | Brush Seal Suits Gaps up to 25 mm | 3000mm | Black | | | |
| | AW82062 | Aluminium Track | 6000mm | Clear Anodised | | | |
| | AW82600 | Nylon Door Stop | - | - | | | |
| | AW83100 | Wheel Assembly with Top Hanger Bracket | - | Stainless | | | |
| | TT84911 | Aluminium Guide Channel | 6000mm | Mill | | | |
| | AW82200 | Track Wall Mount Bracket | - | Stainless | | | |
| | AW83600 | Track End Cap | - | - | | | |
| | AW84200 | End Fix Roller Guide | - | - | | | |
| | AW84500 | Glass Door Clamp (100kg) | - | - | | | |
| | AW84700 | Glass Door Guide | - | - | | | |
| | AW85000 | Door Side Fix Bracket | - | - | | | |
| | ALLWEATHER INTERNAL FOLDING (90kg per panel) | | | | | 50 | |
| | Components & Replacement | AW482SS | 100 mm Intermediate Hinges Set | - | | Stainless | |
| AW483SS | | 100 mm Intermediate Hinges & Handle Set | - | Stainless | | | |
| AW80600 | | Perimeter Seal Q-48 Suits Gaps 2 - 3 mm | - | - | | | |
| AW80800 | | Perimeter Seal Q-21 Suits Gaps 5 - 7.5 mm | - | - | | | |
| AW81200 | | Brush Seal Suits Gaps up to 25 mm | 3000mm | - | | | |
| AW82062 | | Aluminium Track | 6000mm | Clear Anodised | | | |
| AW83500 | | Wheel Assembly with End Hanger Bracket | - | - | | | |
| AW84200 | | End Fix Roller Guide | - | - | | | |
| AW85000 | | Door Side Fix Bracket | - | - | | | |
| AW87000 | | Top Pivot Set with End Hanger Bracket | - | - | | | |
| AW87100 | | Bottom Pivot Set | - | - | | | |
| TT84911 | | Aluminium Guide Channel 20 x 16 x 1.6 mm | 6000mm | Mill | | | |
| ALLWEATHER EXTERNAL FOLDING (90kg per panel) | | | | | 52 | | |
| Components & Replacement | AW482SS | 100 mm Intermediate Hinges Set | - | Stainless | | | |
| | AW483SS | 100 mm Intermediate Hinges & Handle Set | - | Stainless | | | |
| | AW487SS | 100 mm Offset Hinges Set | - | Stainless | | | |
| | AW488SS | 100 mm Offset Hinges & Handle Set | - | Stainless | | | |
| | AW80600 | Perimeter Seal Q-48 Suits Gaps 2 - 3 mm | - | - | | | |
| | AW80800 | Perimeter Seal Q-21 Suits Gaps 5 - 7.5 mm | - | - | | | |

| TYPE | CODE | DESCRIPTION | SIZE | COLOUR | PAGE NO. |
|---|---------|--|--------|----------------|-----------|
| Replacement | AW81200 | Brush Seal Suits Gaps up to 25 mm | 3000mm | - | |
| | AW82062 | Aluminium Track | 6000mm | Clear Anodised | |
| | AW883LH | Top & Bottom Pivot Set LH | - | - | |
| | AW883RH | Top & Bottom Pivot Set RH | - | - | |
| | AW885LH | End Wheel & Guide Set LH | - | - | |
| | AW885RH | End Wheel & Guide Set RH | - | - | |
| | AW886SS | Intermediate Wheel & Guide Set | - | Stainless | |
| | AW888SS | Meeting Wheel & Guide Set | - | Stainless | |
| | TT84911 | Aluminium Guide Channel 20 x 16 x 1.6 mm | 6000mm | Mill | |
| GLIDEMASTER (272kg per door) | | | | | 38 |
| Components & Replacement | TT21551 | Aluminium Single Track | 5000mm | Mill | |
| | TT21600 | Aluminium Heavy Duty Guide | 150mm | Mill | |
| | TT21800 | Heavy Duty Door Stop | - | - | |
| | TT22510 | Race Assembly | - | Clear Anodised | |
| | TT21751 | Wheel with Axle, Nut & Washers | - | - | |
| Optional | TT22061 | Aluminium Coolroom Single Track | 6500 | - | |
| INDUSTRO (450kg per door) | | | | | 40 |
| Components & Replacement | OM51100 | 2 Wheel Assy with M12 x 110 Thread | - | - | |
| | OM51200 | 4 Wheel Assy with M12 x 110 Thread | - | - | |
| | OM51300 | 4 Wheel Assy with M12 x 60 Thread | - | - | |
| | OM51400 | 2 Wheel Assy with Bracket & M16 x 60 Bolt | - | - | |
| | OM51500 | 4 Wheel Assy with Bracket & M16 x 60 Bolt | - | - | |
| | OM52100 | Top Hanger Bracket with M16 Thread | - | - | |
| | OM52200 | Top Hanger Bracket with M12 Thread | - | - | |
| | OM54100 | Door Stop | - | - | |
| | OM55100 | Brass Roller Guide | - | - | |
| | OM56111 | Galvanised Steel Track | 5800mm | - | |
| | OM57111 | Galvanised Steel Guide Channel | 5800mm | - | |
| | OM53100 | Track Wall Mount Bracket with Bolt | - | - | |
| | OM53200 | Track Top Mount Bracket with Bolt | - | - | |
| | OM53300 | Dual Track Wall Mount Bracket with Bolts | - | - | |
| | OM53400 | Track Joiner with Screws | - | - | |
| BARRACUDA BI-FOLD (13kg per panel) | | | | | 42 |
| Pack/Set | P42210 | 2 Leaf Packaged Set | 915mm | Mill | |
| | P42430 | 4 Leaf Packaged Set | 1830mm | Mill | |
| Replacement | S31100 | Top Pivot Set Pack | - | - | |
| | S31200 | Bottom Pivot Set Pack | - | - | |
| | S31500 | Top Guide Assembly Pack | - | - | |
| | TT34600 | Adjustment Spanner 8 & 10mm | - | - | |
| TRIUMPH STEALTH BI FOLD (22kg panel) | | | | | 44 |
| Pack/Set | P38500 | Components Pack | - | - | |
| Components & Replacement | TT32011 | Aluminium Track | 2000mm | Mill | |
| | TT32021 | Aluminium Track | 2500mm | Mill | |
| | TT32031 | Aluminium Track | 3400mm | Mill | |
| | TT32041 | Aluminium Track | 4500mm | Mill | |
| | TT32072 | Aluminium Track | 5560mm | Clear Anodised | |
| | TT38200 | Adjustable Concealed Intermediate (Centre) Hinge | - | - | |
| | TT38500 | Wheel Assembly | - | - | |
| | TT38700 | Clip On Concealed Hinge with Back Plate | - | - | |
| TRIUMPH FOLDING (25kg per panel) | | | | | 48 |
| Pack/Set | P36020 | 2 Leaf Packaged Set | 1220mm | Clear Anodised | |
| | P36030 | 4 Leaf Packaged Set (One Way) | 1830mm | Clear Anodised | |
| | P370CH | Starter Pack - First 2 Leaves | - | Chrome Plated | |
| | P372CH | Add-on Pack - Additional 2 Leaves | - | Chrome Plated | |
| Components & Replacement | TT32011 | Aluminium Track | 2000mm | Mill | |
| | TT32021 | Aluminium Top Mount Track | 2500mm | Mill | |
| | TT32031 | Aluminium Top Mount Track | 3400mm | Mill | |
| | TT32041 | Aluminium Top Mount Track | 4500mm | Mill | |
| | TT32072 | Aluminium Top Mount Track | 5560mm | Clear Anodised | |
| | D003CH | 75 x 47 x 1.6 mm Hipline Hinge with Screws | 75mm | Chrome Plated | |
| | S33700 | Quick Release Wheel Assembly Pack | - | - | |

| TYPE | CODE | DESCRIPTION | SIZE | COLOUR | PAGE NO. |
|---|---------|--|--------|----------------|-----------|
| Components & Replacement | TT33700 | Quick Release Wheel Assembly | - | - | |
| | TT37000 | Top Pivot Set with End Hanger Bracket | - | - | |
| | TT37100 | Bottom Pivot Set | - | - | |
| | TT34600 | Adjustment Spanner 8 & 10 mm | - | - | |
| Optional | D003BR | 75 x 47 x 1.6 mm Hirline Hinge with Screws | 75mm | Brass Plated | |
| | D003SI | 75 x 47 x 1.6 mm Hirline Hinge with Screws | - | P/C Silver | |
| | D32141 | Aluminium Guide Channel | 4500mm | Mill | |
| | S31000 | Spring Loaded Guide Pack | - | - | |
| | TT33800 | Quick Release Door Side Fix Bracket | - | - | |
| OVERLAY BI-FOLD (25kg per panel) | | | | | 46 |
| Components & Replacement | TT39032 | Top Track | 3000mm | Clear Anodised | |
| | TT38200 | Adjustable Concealed Intermediate (Centre) Hinge | - | - | |
| | TT38700 | Clip On Concealed Hinge with Back Plate | - | - | |
| | TT39036 | Aluminium Track | 3000mm | White | |
| | TT39600 | Double Wheel Assembly with hinges | - | - | |
| Optional | TT39800 | Double Roller Guide with hinges | - | - | |
| | TT41332 | Bottom Guide Track | 3000mm | Clear Anodised | |
| QUICK FIX (25kg per door) | | | | | 54 |
| Pack/Set | P23030 | Packaged Set for 2 Doors | 1800mm | Mill | |
| | P23040 | Packaged Set for 3 Doors | 2400mm | Mill (3 Door) | |
| | P23200 | Components Pack for 1 Door | - | - | |
| Components & Replacement | TT23040 | Aluminium Double Track | 3660mm | Mill (Drilled) | |
| | TT23050 | Aluminium Double Track | 4880mm | Mill (Drilled) | |
| | S03100 | Nylon Door Guide Pack | - | - | |
| | S23300 | Wheels with Axle & Nut Pack | - | - | |
| Optional | TT34600 | Adjustment Spanner 8 & 10mm | - | - | |
| | P58826 | Jamb Channel Set | 2470mm | Gloss White | |
| ROBEMAKER (50kg per door) | | | | | 56 |
| Pack/Set | P58012 | Packaged Set for 2 Doors | 1620mm | Clear Anodised | |
| | P58016 | Packaged Set for 2 Doors | 1620mm | Gloss White | |
| | P58020 | Components Bag for 3 Doors | - | - | |
| | P58022 | Packaged Set for 3 Doors | 2420mm | Clear Anodised | |
| | P58026 | Packaged Set for 3 Doors | 2420mm | Gloss White | |
| | P58036 | Packaged Set for 4 Doors | 3240mm | Gloss White | |
| | P58500 | Components Pack for 1 Door | - | - | |
| | P59026 | Packaged Set for 3 Bi-Passing Doors | 2420mm | Gloss White | |
| Components & Replacement | TT58012 | Double Headguide Channel | 5000mm | Clear Anodised | |
| | TT58016 | Double Headguide Channel | 5000mm | Gloss White | |
| | TT58212 | Double Track | 5000mm | Clear Anodised | |
| | TT58216 | Double Track | 5000mm | Gloss White | |
| | TT59016 | Triple Headguide Channel | 5000mm | Gloss White | |
| | TT59216 | Triple Track | 5000mm | Gloss White | |
| | TT58311 | Snap Strip | 5000mm | Mill | |
| | TT58400 | Adjustable Roller Sheave | - | - | |
| Optional | P58826 | Jamb Channel Set | 2470mm | Gloss White | |
| | TT59800 | Robemaker Soft Close Kit | - | - | |
| MIRROR ROBE (50kg per door) | | | | | 58 |
| Components & Replacement | TT56016 | Headguide | 5000mm | White | |
| | TT56216 | Double Track | 5000mm | White | |
| | TT56506 | Handle Bumper | 100m | White | |
| | TT56516 | Handle Trim | 5000mm | White | |
| | TT56600 | Guide with Anti-Jump | - | - | |
| | TT56716 | Rail Trim | 5000mm | White | |
| | TT58311 | Snap Strip | 5000mm | White | |
| | TT79318 | P.V.C. Glazing Wedge for 4mm glass | 20m | Black | |
| | TT90500 | Wardrobe Door Wheel Assembly | - | - | |

| TYPE | CODE | DESCRIPTION | SIZE | COLOUR | PAGE NO. |
|---------------------------------------|---------|---------------------------------------|--------|------------------|-----------|
| CABINETMAKER (20kg per door) | | | | | 60 |
| Pack/Set | P18052 | Packaged Set for 3 Doors | 1800mm | Clear Anodised | |
| | P18056 | Packaged Set for 3 Doors | 1800mm | Gloss White | |
| Components & Replacement | TT18012 | Headguide Channel | 4880mm | Clear Anodised | |
| | TT18016 | Headguide Channel | 4880mm | Gloss White | |
| | TT18212 | Double Track | 4880mm | Clear Anodised | |
| | TT18216 | Double Track | 4880mm | Gloss White | |
| | TT18400 | Adjustable Roller Sheave | - | - | |
| | TT19400 | Cupboardline Adjustable Sheave | - | - | |
| | TT18600 | Door Guide | - | - | |
| | TT58311 | Snap Strip | 5000mm | Mill | |
| TUDOR (20kg per door) | | | | | 62 |
| Components & Replacement | S03000 | Nylon Light Duty Door Guide Pack | - | - | |
| | TT55000 | Wheel Assembly | - | - | |
| | TT55241 | Aluminium Single Track | 4500mm | Mill | |
| MANHATTAN (50kg per door) | | | | | 64 |
| Components & Replacement | S20800 | Nylon Door Guide Pack | - | - | |
| | TT48348 | Aluminium Double Track | 4880mm | Mill | |
| | TT48500 | Race Assembly - 2mm offset | - | - | |
| | TT48600 | Race Assembly - 12.5mm offset | - | - | |
| Optional | P58826 | Jamb Channel Set | 2470mm | Gloss White | |
| EASY ROLLER (25 per door) | | | | | 68 |
| Components & Replacement | TT40000 | Sheave Block (Nylon Wheel) | - | - | |
| | TT41621 | Aluminium Track | 2500mm | Mill | |
| | TT41651 | Aluminium Track | 5000mm | Mill | |
| | TT41652 | Aluminium Track | 5000mm | Clear Anodised | |
| | TT41921 | Aluminium Headguide | 2500mm | Mill | |
| | TT41951 | Aluminium Headguide | 5000mm | Mill | |
| | TT41952 | Aluminium Headguide | 5000mm | Clear Anodised | |
| JIFFY ADJUSTER (28kg per door) | | | | | 70 |
| Components & Replacement | TT41621 | Aluminium Track | 2500mm | Mill | |
| | TT41651 | Aluminium Track | 5000mm | Mill | |
| | TT41652 | Aluminium Track | 5000mm | Clear Anodised | |
| | TT41921 | Aluminium Headguide | 2500mm | Mill | |
| | TT41951 | Aluminium Headguide | 5000mm | Mill | |
| | TT41952 | Aluminium Headguide | 5000mm | Clear Anodised | |
| | TT43000 | Adjustable Sheave Block (Nylon Wheel) | - | - | |
| COASTLINE | | | | | |
| Components & Replacement | TT20811 | Aluminium Headguide (TT208A) | 2500mm | Mill | |
| | TT20841 | Aluminium Headguide (TT208A) | 4500mm | Mill | |
| | TT20852 | Aluminium Headguide (TT208A) | 6000mm | Clear Anodised | |
| | TT20872 | Aluminium Headguide (TT208A) | 6000mm | Clear Anodised | |
| | TT61210 | Manganese Track | 2500mm | Bronze | |
| | TT61220 | Manganese Track | 3000mm | Bronze | |
| | TT61240 | Manganese Track | 4500mm | Bronze | |
| | TT61250 | Manganese Track | 6000mm | Bronze | |
| | TT61241 | Manganese Track | 4500mm | Bronze (Drilled) | |
| | TT61251 | Manganese Track | 6000mm | Bronze (Drilled) | |
| | TT66500 | Adjustable Sheave | - | Stainless | |
| Optional | TT61150 | Brass Track | 6000mm | - | |
| | TT61151 | Brass Track | 6000mm | (Drilled) | |
| | TT66900 | Nylon Head Guide Block | - | - | |

| TYPE | CODE | DESCRIPTION | SIZE | COLOUR | PAGE NO. |
|-------------------------------------|---------|--|--------|------------------|-----------|
| HORIZON (120kg per door) | | | | | 72 |
| Components & Replacement | P66100 | Sheaves with Screws Pack (Nylon Wheel) | - | - | |
| | P67100 | Sheaves with Screws Pack (Steel Wheel) | - | - | |
| | TT20811 | Aluminium Headguide (TT208A) | 2500mm | Mill | |
| | TT20841 | Aluminium Headguide (TT208A) | 4500mm | Mill | |
| | TT20852 | Aluminium Headguide (TT208A) | 6000mm | Clear Anodised | |
| | TT20872 | Aluminium Headguide (TT208A) | 6000mm | Clear Anodised | |
| | TT61210 | Manganese Track | 2500mm | Bronze | |
| | TT61220 | Manganese Track | 3000mm | Bronze | |
| | TT61240 | Manganese Track | 4500mm | Bronze | |
| | TT61250 | Manganese Track | 6000mm | Bronze | |
| | TT61241 | Manganese Track | 4500mm | Bronze (Drilled) | |
| | TT61251 | Manganese Track | 6000mm | Bronze (Drilled) | |
| | TT61311 | Aluminium Track | 2500mm | Mill | |
| | TT61341 | Aluminium Track | 4500mm | Mill | |
| | TT61351 | Aluminium Track | 6000mm | Mill | |
| | TT61361 | Aluminium Track | 4500mm | Mill (Drilled) | |
| | TT61371 | Aluminium Track | 6000mm | Mill (Drilled) | |
| | TT61150 | Brass Track | 6000mm | Brass | |
| | TT61151 | Brass Track (Drilled) | 6000mm | Natural | |
| | TT65000 | Adjustable Roller Sheave (Nylon Wheel) | - | - | |
| Optional | TT65100 | Adjustable Roller Sheave (Steel Wheel) | - | - | |
| | TT65200 | Adjustable Roller Sheave (SS Wheel) | - | - | |
| | TT65408 | Adjustment Access Hole Plug for 8mm Hole | - | Black | |
| | TT66900 | Nylon Head Guide Block | - | - | |
| | TT61800 | Brass Screw 6G x 16 mm (5/8") CSK (Bag of 100) | - | - | |
| | TT61900 | Brass Screw 6G x 19 mm (3/4") CSK (Bag of 100) | - | - | |
| TIMBERLINE (200kg per door) | | | | | 74 |
| Components & Replacement | TT61150 | G380 Bottom Rolling Track | 6000mm | Brass | |
| | TT61151 | G380 Bottom Rolling Track | 6000mm | Brass | |
| | TT65700 | Adjustable Roller Sheave with Bronze Wheel | - | - | |
| MAXI ROLLER (227kg per door) | | | | | 76 |
| Components & Replacement | TT20811 | Aluminium Headguide (TT208A) | 2500mm | Mill | |
| | TT20841 | Aluminium Headguide (TT208A) | 4500mm | Mill | |
| | TT20852 | Aluminium Headguide (TT208A) | 6000mm | Clear Anodised | |
| | TT20872 | Aluminium Headguide (TT208A) | 6000mm | Clear (Drilled) | |
| | TT61210 | Manganese Track | 2500mm | Bronze | |
| | TT61220 | Manganese Track | 3000mm | Bronze | |
| | TT61240 | Manganese Track | 4500mm | Bronze | |
| | TT61250 | Manganese Track | 6000mm | Bronze | |
| | TT61241 | Manganese Track | 4500mm | Bronze (Drilled) | |
| | TT61251 | Manganese Track | 6000mm | Bronze (Drilled) | |
| | TT65500 | Sheave with Bronze Wheel | - | - | |
| Optional | TT66900 | Nylon Head Guide Block | - | - | |
| | TT61150 | Brass Track | 6000mm | Brass | |
| | TT61151 | Brass Track | 6000mm | Brass (Drilled) | |
| | TT61800 | Brass Screw 6G x 16 mm (5/8") CSK (Bag of 100) | - | - | |
| | TT61900 | Brass Screw 6G x 19 mm (3/4") CSK (Bag of 100) | - | - | |





3. GLASS DOOR TRACK SYSTEMS

MKII SASHLESS

ROLLER BEARING 6

ROLLER BEARING 10

BALL BEARING

PLASTIC TRACK

GLASS TRACK ACCESSORIES

LOCKS AND CATCHES

SLIDING GLASS DOOR TRACK SYSTEM

APPLICATION



The Plastic Track double sliding door track is a basic sliding panel system which operates without the use of a rolling mechanism. Panels run simply on the arc of the bottom track while the plastic design reduces friction to allow movement.

The Plastic Track is very easy to install and is ideal for small cabinets and vanities with infrequent use.

FEATURES

- Ideal for small cupboards & cabinets
- Suits glass or mirror panels
- Suits 5mm thick timber panels

DETAILS

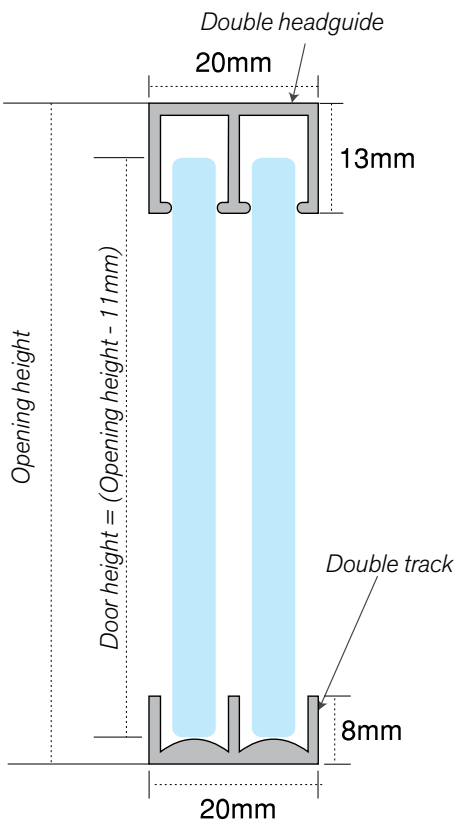

TECHNICAL SPECIFICATIONS

| | |
|--------------------------|---------------------|
| Max. Door Weight: | 6kg per door |
| Max. Door Size: | 0.562m ² |
| Max. Door Height: | 760mm |

Double track for 5mm float & mirror glass panels

GLASS PREPARATION DETAILS:

Cowdroy recommends all glass have polished edges and rounded or tipped corners.

* Full product codes & options refer to **page 100**

COMPONENTS



Double head
guide channel



Double track



Finger pull



SLIDING GLASS DOOR TRACK SYSTEM

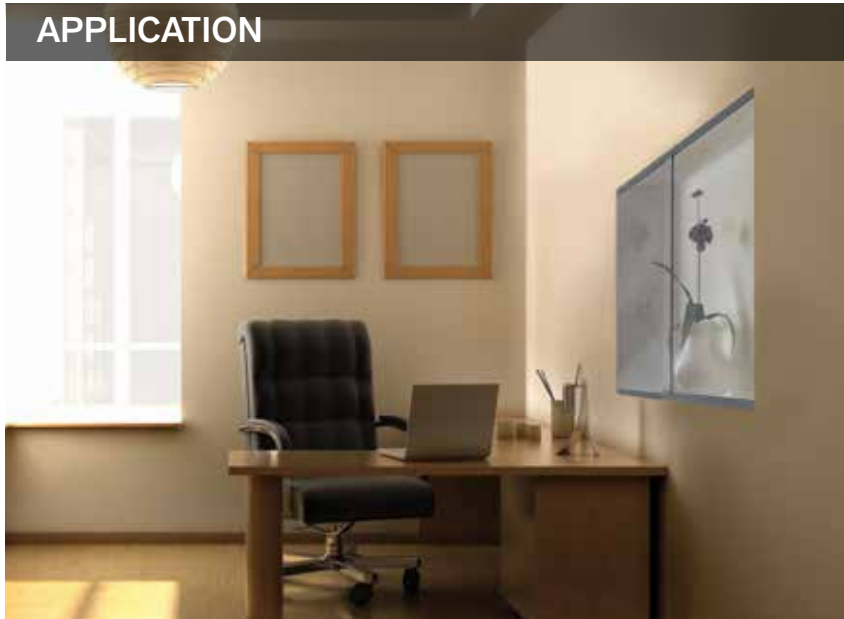

The **Ball Bearing** double sliding door system is a simple glass door system utilising free-running ball bearings inside the bottom track and is designed for simple installation.

Used in applications such as cabinets, vanities and small internal windows, the **Ball Bearing** sliding door system is only to 2 door applications but may also be used in multiples of 2 by running multiple tracks next to each other.

DETAILS

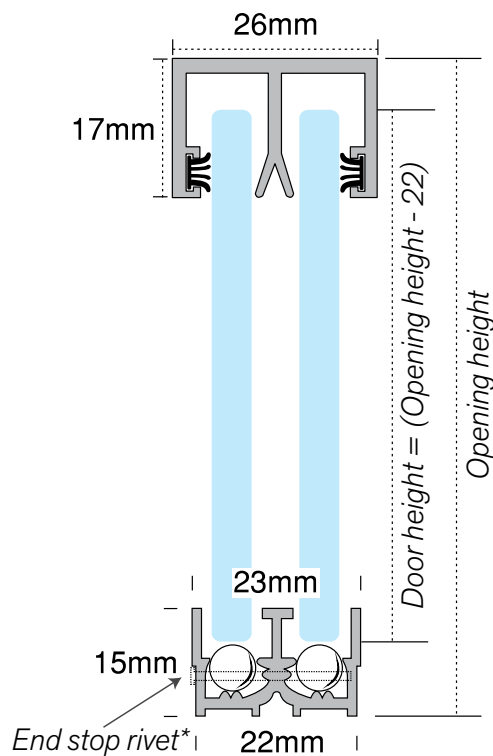

| TECHNICAL SPECIFICATIONS | |
|--------------------------|--|
| Max. Door Weight: | 22kg per panel |
| Max. Door Size: | 1.40m ² |
| Max. Door Height: | 1220mm |
| Glass Height: | Opening height - 22mm |
| Glass Width: | Half opening width + 25mm <i>(Will give a 50mm overlap)</i> |
| No. Balls: | 92 Balls per metre per channel |

Double track for 6mm float & 6.38mm laminate glass panels

*End stop rivet is only required when doors have an open end(s).

GLASS PREPARATION DETAILS:

Cowdroy recommends all glass have polished edges and rounded corners to 10mm.

* Full product codes & options refer to **page 100**

COMPONENTS



Double head guide



Double track

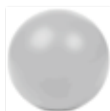

Stainless steel ball
(Bags of 440)



Nylon ball
(Bags of 440)



Finger pull

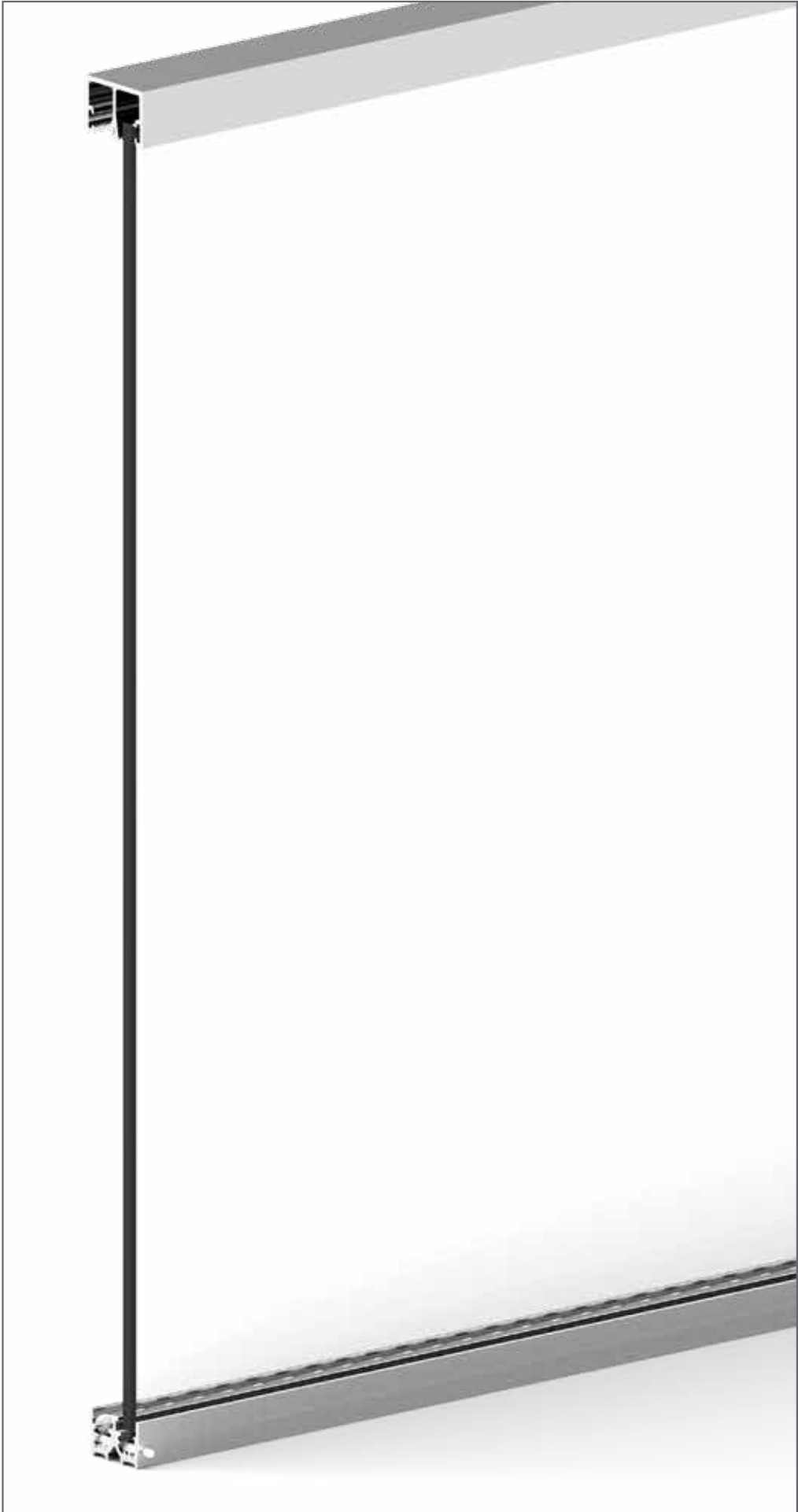

SLIDING GLASS DOOR TRACK SYSTEM

APPLICATION



The Roller Bearing 6 double sliding door system is a versatile glass door system which is slimline in design for maximum visibility yet strong enough to carry 45kg glass panels. Ideal for use in cabinets and vanities as well as small reception windows and display windows.

The Roller Bearing 6 single sliding door system is a great compliment to the double track version. It features all of the same characteristics but in a single track.

Ideal for use as a third door or as a stand alone panel for single access requirements. It may also be used for small cavity style windows and access openings.

DETAILS

GLASS PREPARATION DETAILS:

Cowdroy recommends all glass have polished edges and rounded or tipped corners.

TECHNICAL SPECIFICATIONS

| | |
|--------------------------|--|
| Max. Door Weight: | 60kg per panel |
| Max. Door Size: | 3.78m ² |
| Max. Door Height: | 1800mm |
| Glass Height: | Opening height - 36mm for double Opening height - 42 for single |
| Glass Width: | Half opening width + 25mm (Will give a 50mm overlap) |

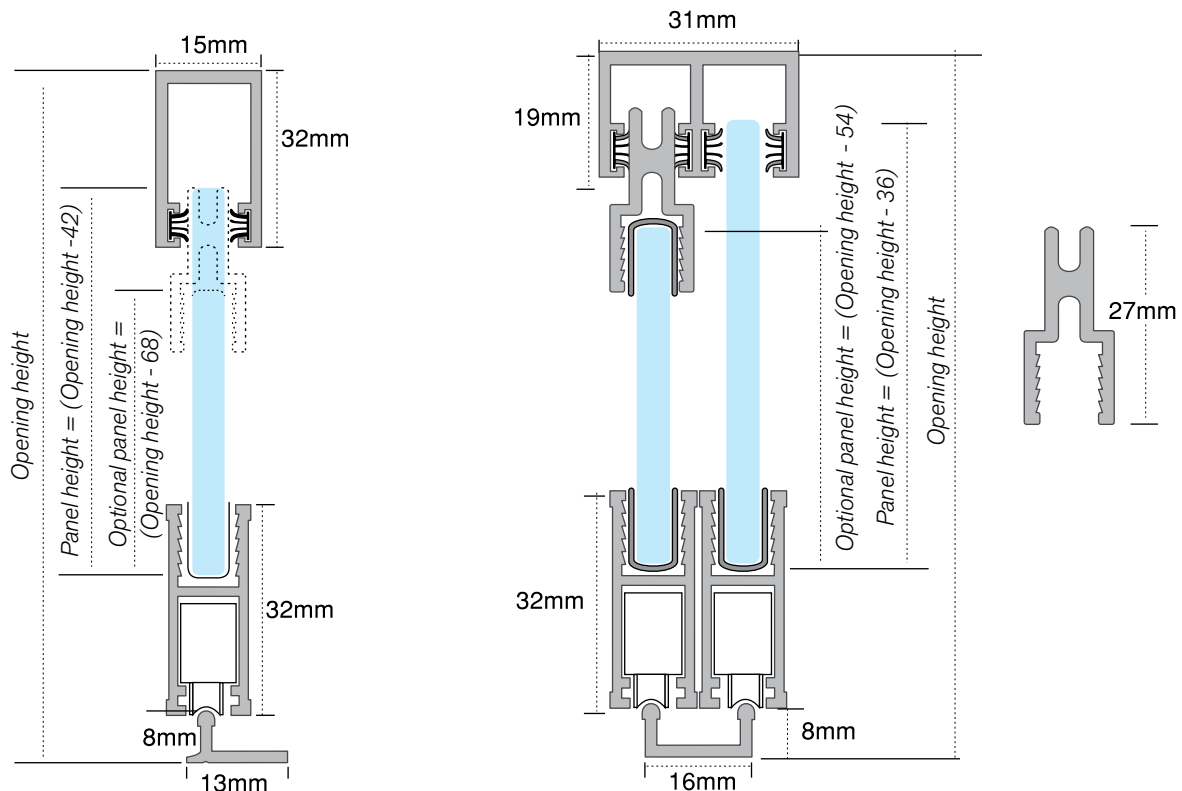

Single Track For 6mm Float & 6.38mm Laminate Glass Panels

Double Track For 6mm Float & 6.38mm Laminate Glass Panels

* Full product codes & options refer to **page 100**

COMPONENTS



Double head guide



Single head guide



Race



Single track



Double track



Roller assembly
(Nylon 30kg/pair)

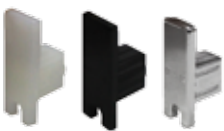

Nylon end plates



Finger pull



Head race
(Optional extra)



Single track

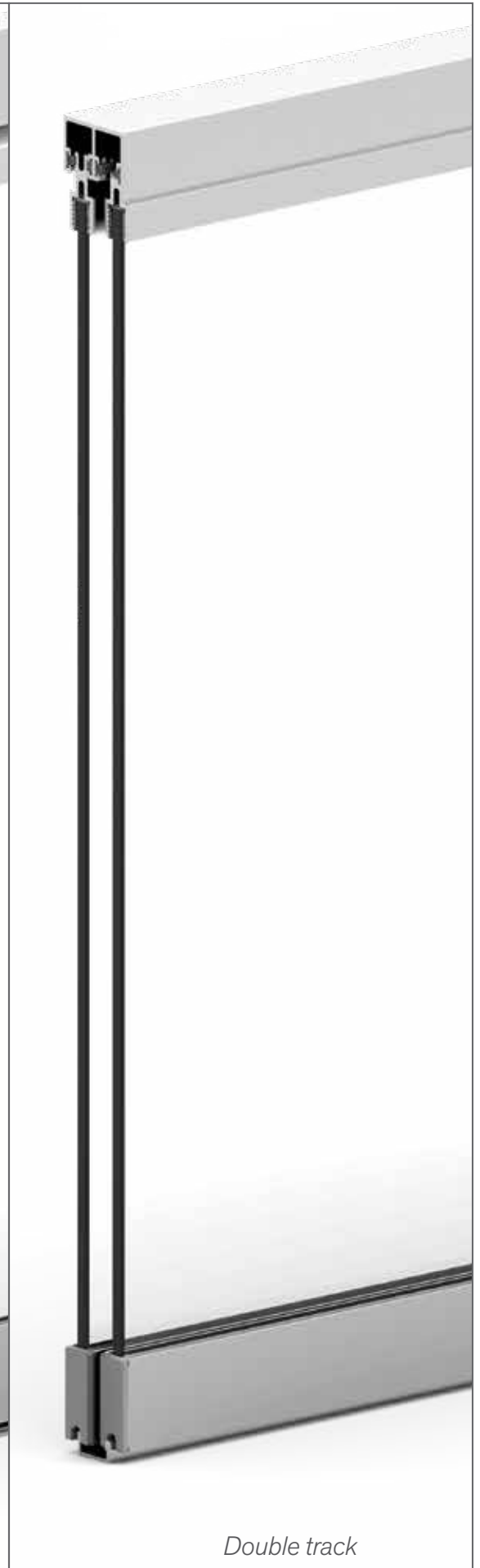

Double track

SLIDING GLASS DOOR TRACK SYSTEM

APPLICATION



The **Roller Bearing 10** double sliding door system is an adjustable glass door system which is slimline in design for maximum visibility yet robust enough to carry large 200kg glass panels.

Ideal for use in large cabinets and vanities, reception windows and display windows, the **Roller Bearing 10** sliding door system is best suited to 1 and 2 door applications but may also be used for 3 or 4 door applications by running multiple panels on each track or multiple tracks.

DETAILS

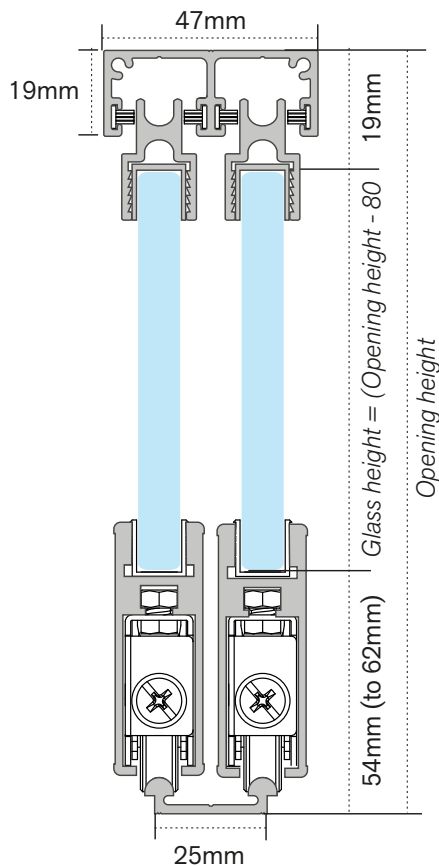

TECHNICAL SPECIFICATIONS

| | |
|--------------------------|---|
| Max. Door Weight: | 200kg per panel |
| Max. Door Size: | 3.35m ² |
| Max. Door Height: | 2400mm |
| Glass Height: | Opening height - 65mm |
| Glass Width: | Half opening width + 50mm <i>(Will give a 100mm overlap)</i> |

Double Track for 10mm & 10.38mm laminate glass panels

GLASS PREPARATION DETAILS:

Cowdroy recommends all glass have polished edges and rounded or tipped corners.

* Full product codes & options refer to **page 100**

COMPONENTS



Double head guide



Race



Double track



Double wheel assembly
(200kg/pair)



Roller assembly
(50kg/pair)



Nylon end plate

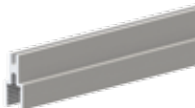

Head race
(Optional extra)

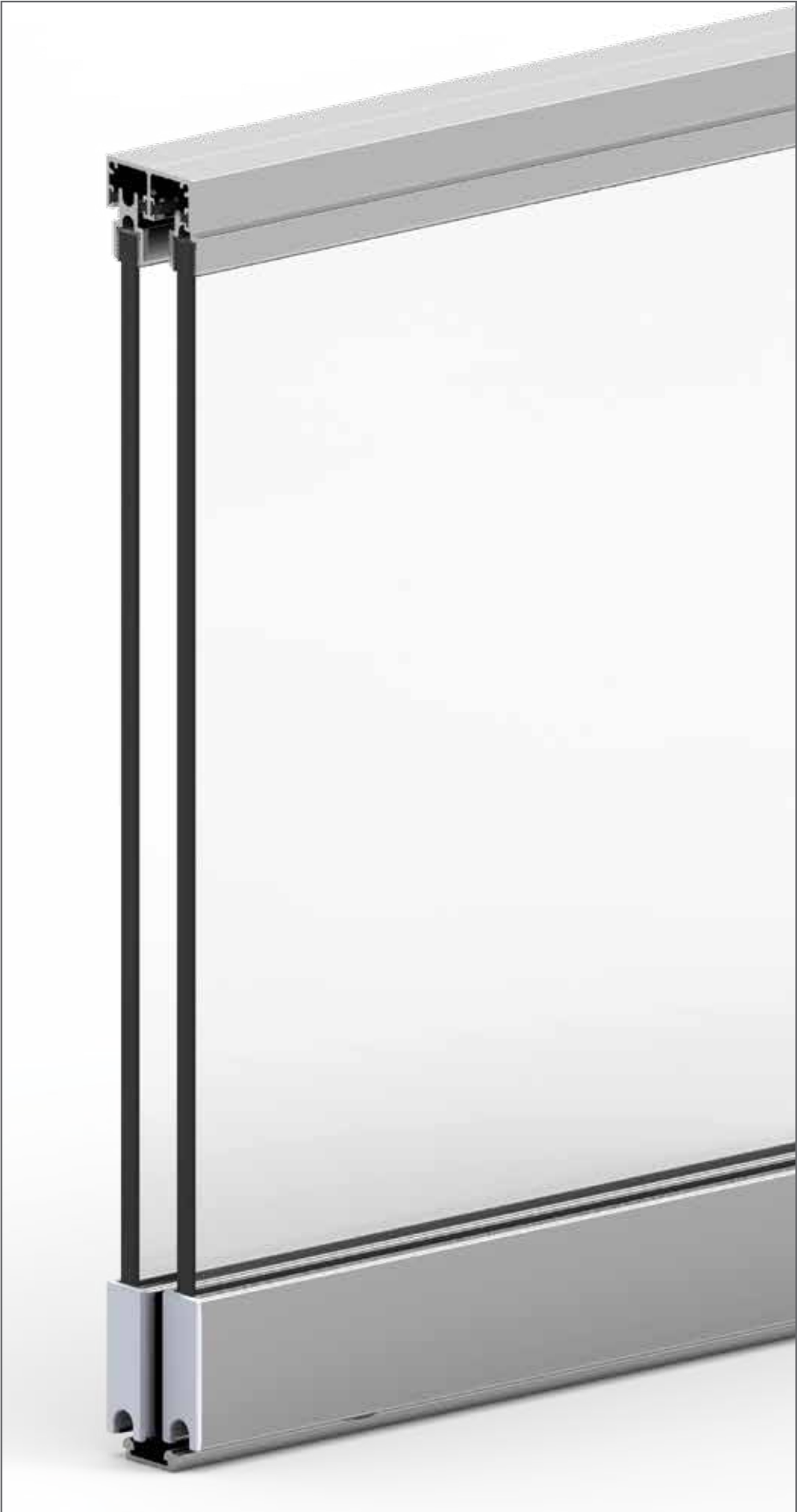

SLIDING GLASS DOOR/WINDOW TRACK SYSTEM

APPLICATION



The **MKII Sashless** window system is designed for maximum visibility. With all framework contained to the outer edges the result of an unobtrusive view and maximum light.

It is best suited for use in partially covered or protected areas (eg. under awnings or eaves) such that protection is afforded against driving wind and rain. Also ideal for use on large cabinets, reception windows and display windows.

The **MKII Sashless** window system is best suited to 2 panel applications but may also be used for 4 door applications by running multiple panels on each track or multiple tracks.

DETAILS

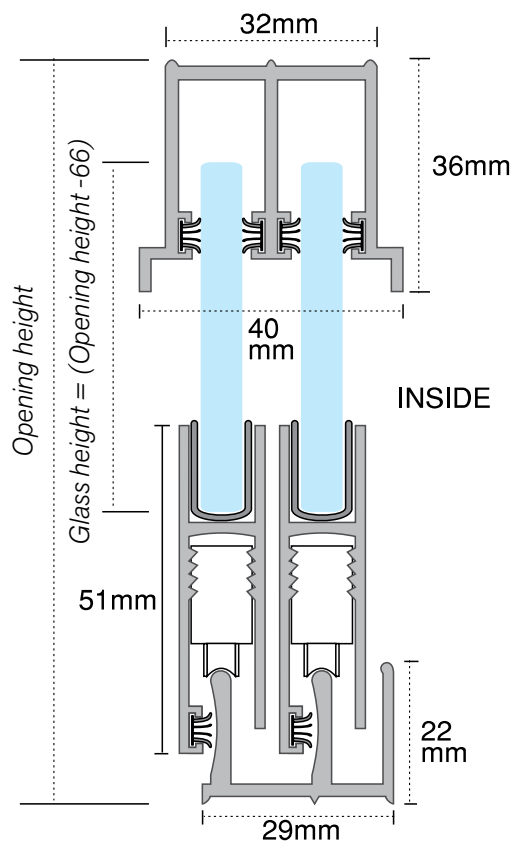

TECHNICAL SPECIFICATIONS

- Max. Door Weight:** 52kg per panel
- Max. Door Size:** 3.25m²
- Max. Door Height:** 1525mm
- Glass Height:** Opening height - 66mm
- Glass Width:** Half opening width + 50mm
(Will give a 100mm overlap)

USE OF MULLION AND EDGE BRACE

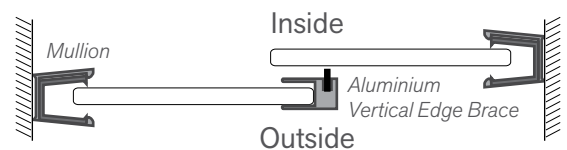

USE OF MULLION AND EDGE BRACE

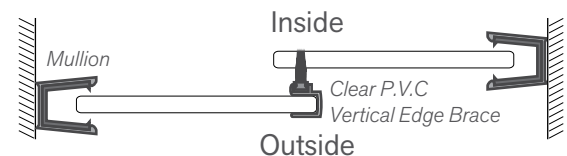

Double track for 6mm float & 6.38mm laminate glass panels

GLASS PREPARATION DETAILS:

Cowdroy recommends all glass has polished edges and rounded or tipped corners.

* Full product codes & options refer to **page 100**

COMPONENTS



Double head guide



Double track and race



Roller assembly



Nylon end plates

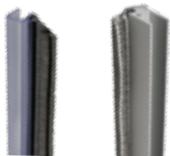

Vertical edge braces



Mullion channel











LOCKS AND CATCHES

* Full product codes & options refer to **page 101**

All keyed locks are available as Keyed Alike (K/A) or Keyed to Differ (K/D) unless indicated otherwise.

Keyed Alike locks are kept in batches of numbers. However, as batches continually change, Cowdroy cannot guarantee that any particular key number is available at any given time.

| | |
|--|--|
| <p>F603 KEYED PLUNGER LOCK FOR SLIDING DOORS Designed to suit Roller Bearing 6 and MKII Sashless. Chrome finish. Key blanks are also available. Fits into any area of the door race.</p>  | <p>F604 KEYED PLUNGER LOCK FOR SLIDING DOORS Designed suit Roller Bearing 6 and MKII Sashless. Chrome plated. Key blanks are also available. Fits into either end of door race with reversible holder.</p>  |
| <p>F609 KEYED CAM LOCK FOR HINGED DOORS 90 degrees swing down mechanism. Long and short barrel to suit varying panels. Chrome finish. Designed to fit directly through door panel. 16mmØ hole required.</p>  | <p>F607 KEYED PIN PROJECTION LOCK Designed to fit directly through door panel. 23mmØ hole required. Satin Chrome finish. Suitable for 6, 8 and 10mm panels.</p>  |
| <p>F614 KEYED PLUNGER LOCK FOR SLIDING DOORS Chrome plated finish. Fits into either end of door race with reversible holder. Suits Roller Bearing 10.</p>  | <p>TT86 KEYED RATCHET LOCK FOR SLIDING DOORS Wrap-around fitting suitable for 6mm panels. Adjusts to fit door overlaps up to 100mm. Chrome finish. Keyed to differ only.</p>  |
| <p>TT765 KEYLESS PLUNGER CATCH & BRACKET General purpose catch with angled bracket for sliding panels. May be used with TT71.</p>  | <p>TT856 KEYLESS PLUNGER CATCH & BRACKET General purpose catch with straight bracket for sliding panels. May be used with TT71.</p>  |



PRODUCT CODE INDEX - GLASS DOOR TRACK SYSTEMS

| CODE | DESCRIPTION | SIZE | COLOUR | PAGE NO. |
|--|---|--------|----------------|-----------|
| PLASTIC TRACK (6kg per panel) | | | | 88 |
| P02614 | Packaged Set (2 Doors) | 1200mm | Brown | |
| P02616 | Packaged Set (2 Doors) | 1200mm | White | |
| P02624 | Packaged Set (2 Doors) | 1800mm | Brown | |
| P02626 | Packaged Set (2 Doors) | 1800mm | White | |
| BALL BEARING (22kg per door) | | | | 90 |
| TT02011 | Aluminium Double Headguide with Pile | 4500mm | Mill | |
| TT02012 | Aluminium Double Headguide with Pile | 4500mm | Clear Anodised | |
| TT07400 | Nylon Ball | - | - | |
| TT07700 | Stainless Ball | - | - | |
| TT41511 | Aluminium Double Track | 4500mm | Mill | |
| TT41512 | Aluminium Double Track | 4500mm | Clear Anodised | |
| ROLLER BEARING 6 (60kg per panel) | | | | 92 |
| TT02111 | Aluminium Double Headguide with Pile | 4500mm | Mill | |
| TT02112 | Aluminium Double Headguide with Pile | 4500mm | Clear Anodised | |
| TT02311 | Aluminium Single Headguide with Pile | 4500mm | Mill | |
| TT02312 | Aluminium Single Headguide with Pile | 4500mm | Clear Anodised | |
| TT04711 | Aluminium Double Track | 4500mm | Mill | |
| TT04712 | Aluminium Double Track | 4500mm | Clear Anodised | |
| TT04811 | Aluminium Race Section with Pile | 4500mm | Mill | |
| TT04812 | Aluminium Race Section with Pile | 4500mm | Clear Anodised | |
| TT08700 | Glazing Rubber | 20m | - | |
| TT08710 | Glazing Rubber | per m | - | |
| TT08730 | Glazing Rubber | 30m | - | |
| TT41611 | Aluminium Track | 2000mm | Mill | |
| TT41621 | Aluminium Track | 2500mm | Mill | |
| TT41631 | Aluminium Track | 3000mm | Mill | |
| TT41651 | Aluminium Track | 5000mm | Mill | |
| TT41652 | Aluminium Track | 5000mm | Clear Anodised | |
| TT50000 | Adjustable Sheave (TT500A) | - | (SS Wheel) | |
| TT50010 | Adjustable Sheave (TT500B) | - | (Nylon Wheel) | |
| TT02411 | Aluminium Head Race | 4500mm | Mill | |
| TT02412 | Aluminium Head Race | 4500mm | Clear Anodised | |
| TT04606 | Nylon End Plate | - | White | |
| TT04608 | Nylon End Plate | - | Black | |
| TT04613 | Nylon End Plate | - | Bright Silver | |
| TT08900 | Glazing Wedge | 40m | - | |
| TT08910 | Glazing Wedge | per m | - | |
| TT01900 | Nylon Anti-lift Clip | - | - | |
| ROLLER BEARING 10 (200kg per panel) | | | | 94 |
| P51000 | Adjustable Roller Sheave (Nylon Wheel) | - | - | |
| P51500 | Adjustable Twin Roller Sheave (Nylon Wheel) | - | - | |
| TT02512 | Aluminium Double Headguide with Pile | 4500mm | Clear Anodised | |
| TT02912 | Aluminium Head Race | 4500mm | Clear Anodised | |
| TT05606 | Nylon End Plate | - | White | |
| TT05613 | Nylon End Plate | - | Bright Silver | |
| TT05712 | Aluminium Double Track | 4500mm | Clear Anodised | |
| TT05812 | Aluminium Race Section | 4500mm | Clear Anodised | |
| TT08700 | Glazing Rubber | 20m | - | |
| TT08710 | Glazing Rubber | per m | - | |
| TT08900 | Glazing Wedge | 40m | - | |
| TT08910 | Glazing Wedge | per m | - | |
| MKII SASHLESS (52kg/window) | | | | 96 |
| TT02211 | Aluminium Double Headguide with Pile | 4500mm | Mill | |
| TT02212 | Aluminium Double Headguide with Pile | 4500mm | Clear Anodised | |
| TT05211 | Aluminium Race Section with Pile | 4500mm | Mill | |

PRODUCT CODE INDEX - GLASS DOOR TRACK SYSTEMS

| CODE | DESCRIPTION | SIZE | COLOUR | PAGE NO. |
|---------|--|------------|----------------|----------|
| TT05212 | Aluminium Race Section with Pile | 4500mm | Clear Anodised | |
| TT05311 | Aluminium Double Track | 4500mm | Mill | |
| TT05312 | Aluminium Double Track | 4500mm | Clear | |
| TT08700 | Glazing Rubber | 20m | - | |
| TT08710 | Glazing Rubber | per m | - | |
| TT08730 | Glazing Rubber | 30m | - | |
| TT52000 | Adjustable Sheave | (SS Wheel) | - | |
| TP00610 | Clear P.V.C. Weather Strip | 30m | - | |
| TT05406 | Nylon End Plate | - | White | |
| TT05408 | Nylon End Plate | - | Black | |
| TT08900 | Glazing Wedge | 40m | - | |
| TT08910 | Glazing Wedge | per m | - | |
| TT12910 | Black P.V.C. Mullion Insert (TT129A) | 30m | - | |
| TT12911 | Aluminium Mullion Channel | 4500mm | Mill | |
| TT12912 | Aluminium Mullion Channel | 4500mm | Clear Anodised | |
| TT13011 | Alum. Vertical Edge Brace with Pile | 4500mm | Mill | |
| TT13012 | Alum. Vertical Edge Brace with Pile | 4500mm | Clear Anodised | |
| TT13511 | Clear P.V.C. Vertical Edge Brace with Pile | 3000mm | - | |

GLASS TRACK ACCESSORIES - LOCKS AND CATCHES

98

| | | | | |
|---------|--|--|--------------|--|
| F60300 | Sliding Door Keyed Plunger Lock (Front) KA | | Chrome | |
| F60310 | Sliding Door Keyed Plunger Lock (Front) KD | | Chrome | |
| F60407 | Sliding Door Keyed Plunger Lock (End - Long) KA | | Chrome | |
| F60417 | Sliding Door Keyed Plunger Lock (End - Long) KD | | Chrome | |
| F60427 | Sliding Door Keyed Plunger Lock (End - Short) KD | | Chrome | |
| F60410 | Key Blank for F604 | | - | |
| F60620 | Key Blank for F603 | | - | |
| F60700 | Keyed Pin Projection Lock KA | | Satin Chrome | |
| F60710 | Keyed Pin Projection Lock KD | | Satin Chrome | |
| F60907 | Hinged Door Keyed Cam Lock (Short Barrel) KA | | Chrome | |
| TT07100 | Ring Set for 6 mm Glass | | Chrome | |
| T08600 | Ratchet Lock KD only | | Chrome | |
| TT76500 | Plunger Catch with Bracket (Angled) | | - | |
| TT85600 | Plunger Catch with Bracket (Straight) | | - | |
| P703SC | Cavity Finger Pull Pack | | Satin Chrome | |

HANDIFRAME MIRROR FRAME (38kg per frame)

| | | | | |
|---------|-------------------------------------|--------|-----------|--|
| A30910 | P.V.C. Glazing Wedge for 6 mm Glass | 100m | | |
| A31312 | Alum. Frame | 4500mm | ClearAnod | |
| A31400 | Nylon Wall Fixing Clip | - | - | |
| A31900 | Nylon Corner Joiner | - | - | |
| TT79318 | P.V.C. Glazing Wedge for 4 mm Glass | 20m | Black | |





SLIDING DOOR SHEAVES



QUICK FIX DOOR GUIDE



TRIUMPH CONCEALED
DOOR STOP

4. REPLACEMENT COMPONENTS & ACCESSORIES

WHEELS
CAPPING TRACK
DOOR GUIDES
DOOR STOPS
PELMETS
DOOR COLLECTOR SEALS
CABINET DOOR HINGES
SOFT-CLOSE ADAPTORS
SOFT-CLOSE FOR DOORS & DRAWERS
DOOR FURNITURE

REPLACEMENT WHEELS, ROLLERS AND SHEAVES

SPARE PARTS COMPONENTS

DO IT YOURSELF

The Cowdroy range of replacement wheels, rollers and parts are ideal for those worn, stubborn or dysfunctional sliding windows and doors. Common symptoms of malfunctioning sliding components include the following:

- Excessive noise or grinding sound
- Extensive wear and tear on tracks
- Windows or doors do not slide freely
- Windows or doors feel bumpy when sliding
- Windows or doors are jammed

In most cases these worn parts are simple to replace and maintain.

DEFINITIONS

Small (Cupboards & Windows)

Up to 27mm diameter

Medium (Doors)

28mm to 36mm diameter

Large (Wardrobes)

38mm diameter and over

Screen Doors

Up to 15kg

GUIDELINES

It is generally recognised as good maintenance practice to replace components in sets (e.g. pairs of rollers or guides) in order to retain lifespan of replacement parts as well as to maximise sliding performance.

Whether it be sliding flyscreen, patio, security or wardrobe doors, in the majority of instances the procedure of removing rollers is quite similar.

Many rollers are adjustable. This adjustment may be actuated by either a screw or a nut. Generally, bottom sliding systems are screw adjustable and top sliding systems are nut adjustable. (Some roller assemblies are spring loaded and may be removed easily). The following steps will help in the removal and replacement of rollers.

1. Identify the adjustment mechanism (i.e. screws or nuts).
2. Should there be no visible means of adjustment then it may be possible to lift and remove the window or door without altering its position.
3. Loosen adjustment to allow door to lower. (In screw adjustment turn screw anti-clockwise to lower door. In nut adjustment loosen the nuts on the rear of the race assembly to lower door then re-tighten slightly once door has "dropped").
4. With adjustment now loose you should be able to lift and manoeuvre the window/door off the track and guides.
5. In some instances, such as glass patio doors, the removal of a fixed panel may be necessary in order to remove the door.
6. Rollers can be removed from panels quite easily as most are either screwed, bolted, clipped or spring loaded.
7. Assess your track for damage and cleanliness. You may want to clean the track and, in some cases, your track may need a light sanding to ensure your rollers run as smooth as possible.
8. Replace rollers and re-install doors by reversal of the sbove mentioned procedures.
9. It may be necessary to adjust rollers in order to ensure correct operation of latching/locking mechanism if present.
10. Should you not be confident with any aspect of the above procedures we recommend you consult a qualified window or door repairer.

WHEELS WITH AXLE AND NUT

* Full product codes & options refer to **page 120-121**

All wheels are nylon tyred unless stated otherwise.

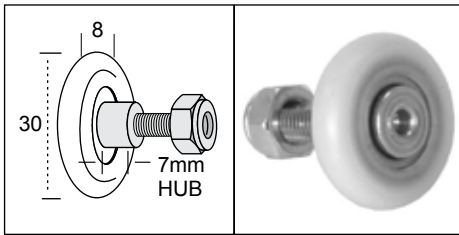

Centurion
S10400 (Pack of 2) Max. 30kg each

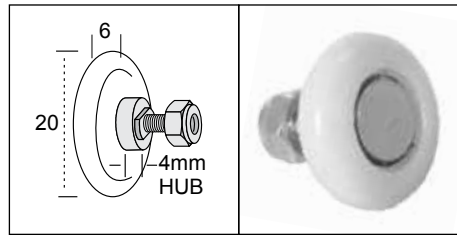

Quick-Fix
S23300 (Pack of 2) Max. 12kg each

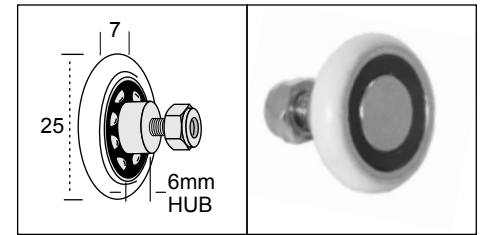

Arrow
S68100 (Pack of 2) Max. 18kg each

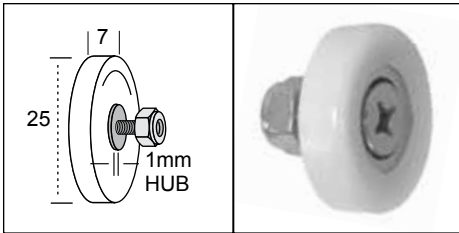

Flat - Threaded Axle
S91200 (Pack of 2) Max. 25kg each

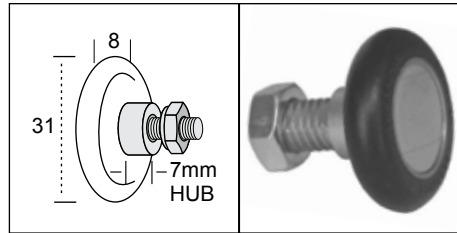

Round - Threaded Axle
S91300 (Pack of 2) - Max. 30kg each

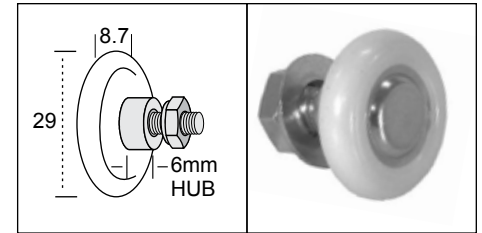

Round - Threaded Axle
S93600 (Pack of 2) - Max. 35kg each

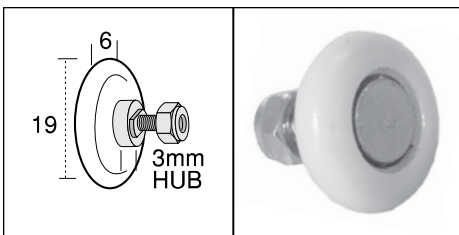

Round - Threaded Axle
S45400 (Pack of 2) Max. 8kg each

WHEELS WITH AXLE AND SCREW

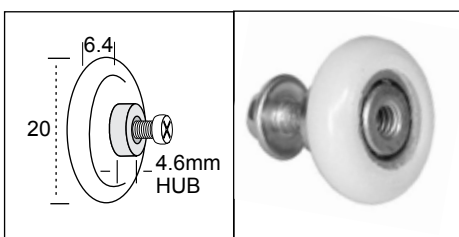

Round - Threaded Bore
S90200 (Pack of 2) Max. 10kg each

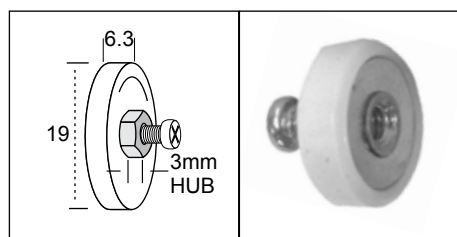

Flat - Threaded Bore
S91000 (Pack of 2) Max. 5kg each

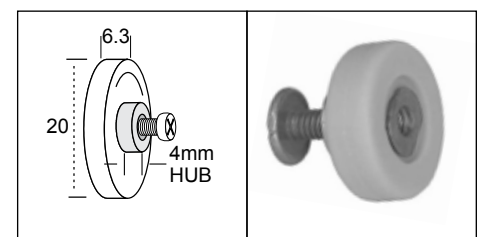

Flat - Threaded Bore
S91100 (Pack of 2) Max. 15kg each

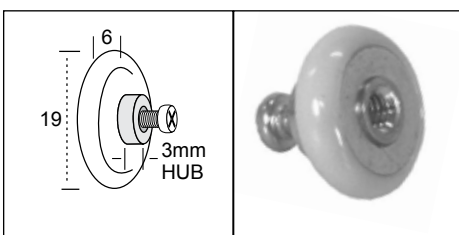

Round - Threaded Bore
S93000 (Pack of 2) Max. 5kg each

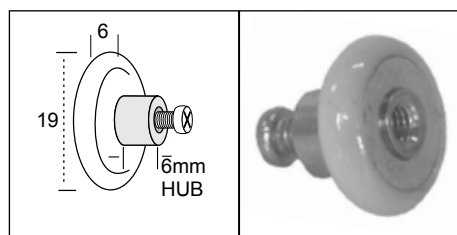

Round - Threaded Bore
S93200 (Pack of 2) Max. 5kg each

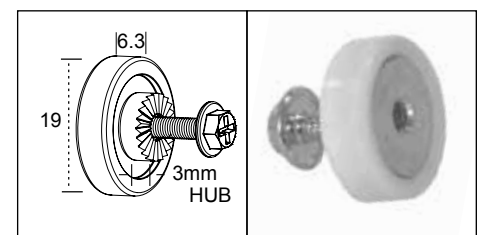

Flat - Threaded Bore
S93300 (Pack of 2) Max. 10kg each

REPLACEMENT WHEELS, ROLLERS AND SHEAVES

WHEELS WITH BORE

* Full product codes & options refer to **page 120-121**

All wheels are nylon tyred unless stated otherwise.

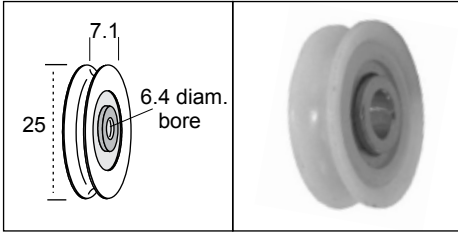

Concave - 6.4mm Bore
S92200 (Pack of 2) Max. 15kg each

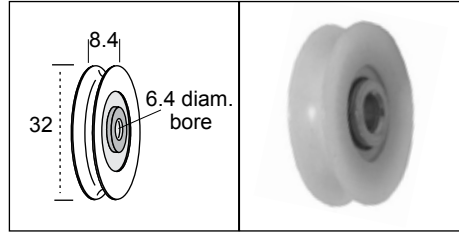

Concave - 6.4mm Bore
S92400 (Pack of 2) Max. 25kg each

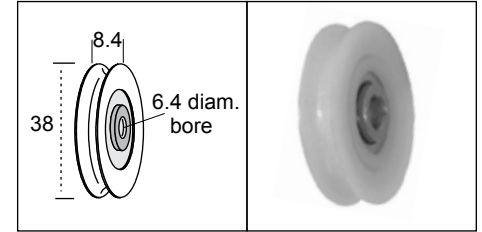

Concave - 6.4mm Bore
S92600 (Pack of 2) Max. 30kg each

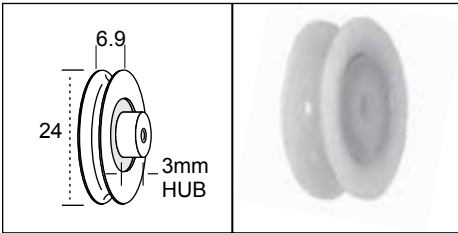

Concave - Threaded Bore
S92700 (Pack of 2) Max. 12kg each

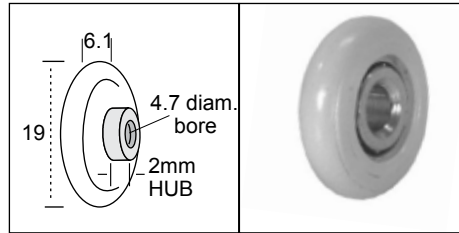

Round - 4.7mm Bore
S93100 (Pack of 2) Max. 5kg each

WHEELS WITH AXLE

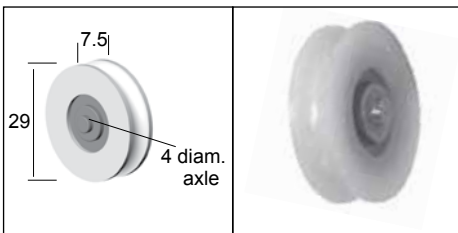

Concave Wheel for Security/Flyscreen
S91800 (Pack of 2) Max. 15kg each

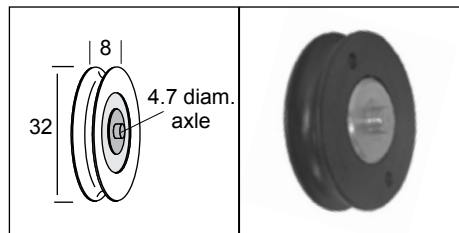

Concave - 4.7mm Axle
S92000 (Pack of 2) Max. 25kg each

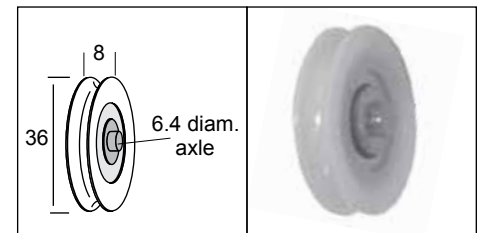

Concave - 6.4mm Axle
S92100 (Pack of 2) Max. 25kg each

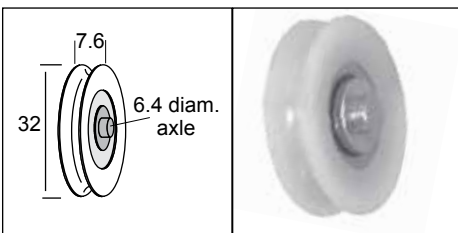

Concave - 6.4mm Axle
S92500 (Pack of 2) Max. 25kg each

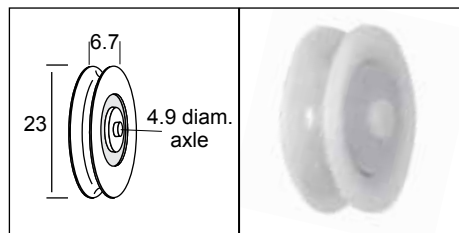

Concave - 4.9mm Axle
S92800 (Pack of 2) Max. 12kg each

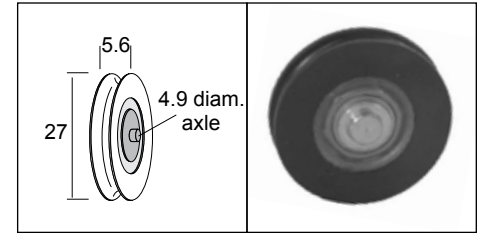

Concave - 4.9mm Axle
S94000 (Pack of 2) Max. 15kg each

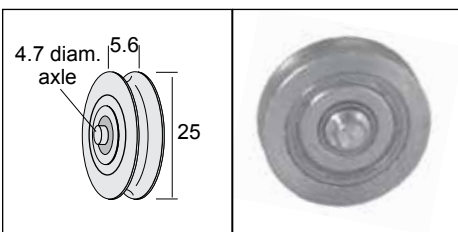

Concave Stainless Steel - 4.7mm Axle
S94800 (Pack of 2) Max. 25kg each

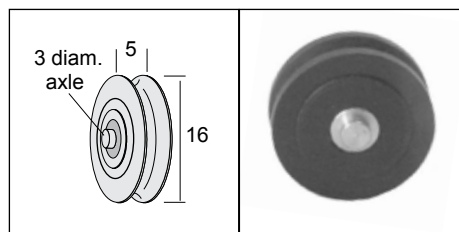

Concave Wheel For Sliding Window
S97000 (Pack of 2) Max. 12kg each

SMALL SHEAVES - HORIZONTAL for window/screens

* Full product codes & options refer to **page 120-121**

All wheels are nylon tyred unless stated otherwise.

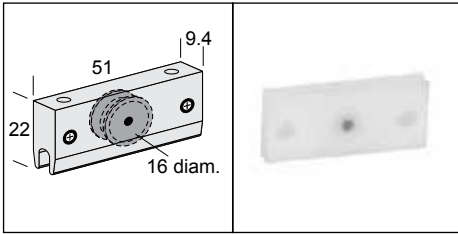

Easy Roller
TT40000 Concave Wheel
Max. 12.5kg each

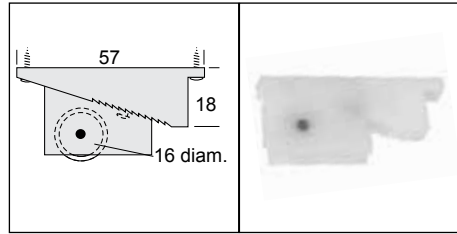

Jiffy Adjuster
TT43000 Concave Wheel
Max. 14kg each

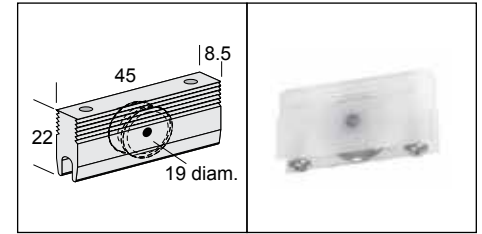

TT52000 Concave Stainless Steel Wheel
Sashless Window
Max. 29kg each

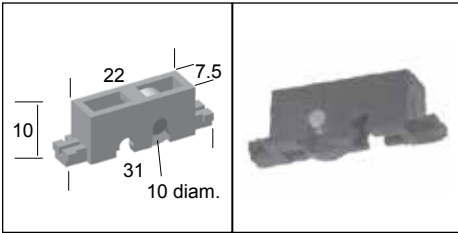

Flat wheel sheave for sliding window
S91900 (Pack of 2) Max. 12kg each

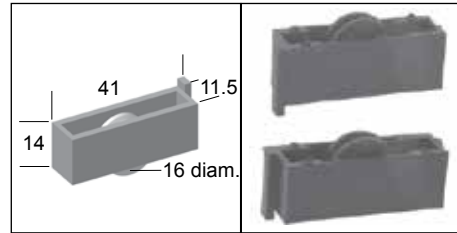

Concave wheel sheave for sliding window
S97600 (Pack Set of 2) Max. 12kg each

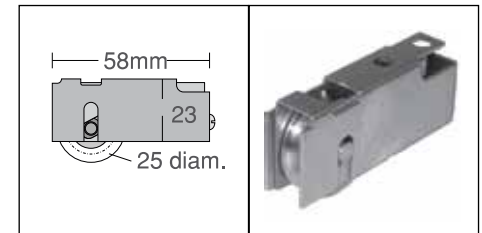

Concave Wheel Joinery Sheave
304 Stainless Steel Casing
TT66200 - Max. 20kg each

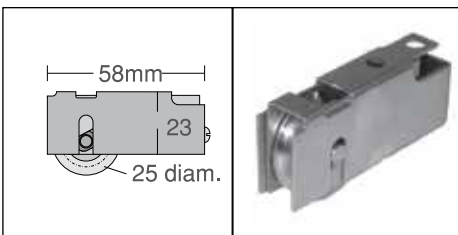

Concave Wheel Joinery Sheave
All 304 Stainless Steel
TT66300 - Max. 30kg each

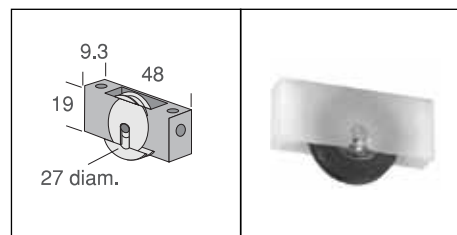

Concave Wheel Sheave
for Sliding Window
S94100 (Pack of 2) - Max. 15kg each

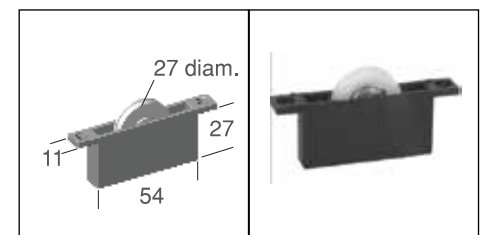

Concave Wheel Sheave
for Security/Flyscreen
S96300 (Pack of 1) Max. 15kg each

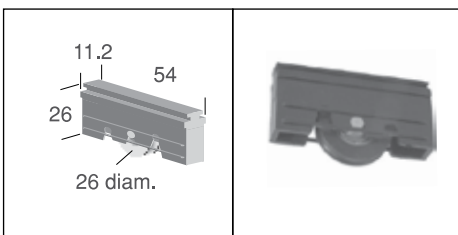

Concave Wheel Sheave
for Security/Screen
S98500 (Pack of 2) Max. 15kg each

SMALL SHEAVES - VERTICAL for window/screens

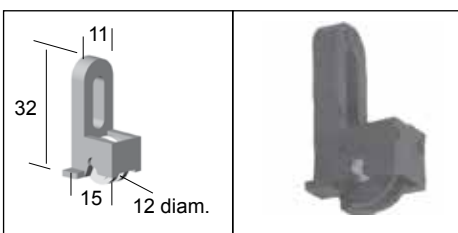

Concave Wheel Sheave
for Sliding Window
S97800 (Pack of 2) Max. 12kg each

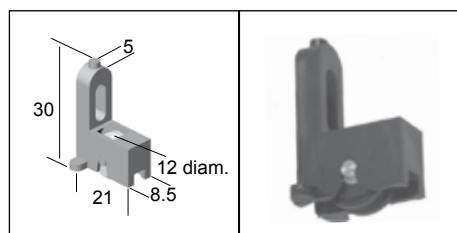

Concave Wheel Sheave
for Sliding Window
S97900 (Pack of 2) Max. 25kg each

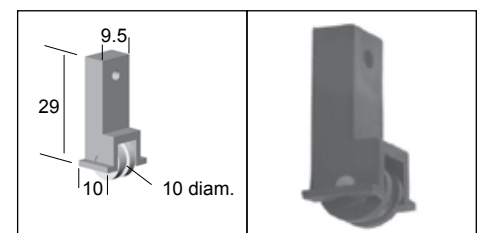

Concave Wheel Sheave
for Sliding Window
S98000 (Pack of 2) Max. 12kg each

REPLACEMENT WHEELS, ROLLERS AND SHEAVES

MEDIUM SHEAVES - HORIZONTAL for doors

* Full product codes & options refer to **page 120-121**

All wheels are nylon tyred unless stated otherwise.

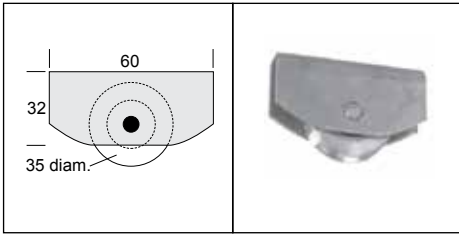

Maxi Roller
Concave Bronze Wheel
TT65500 - Max. 113kg each

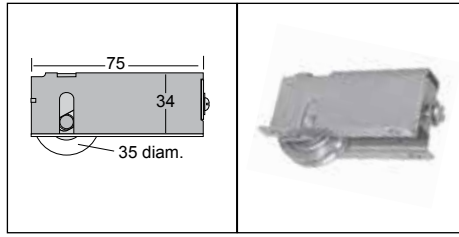

Timberline
Concave Bronze Wheel
TT65700 - Max. 100kg each

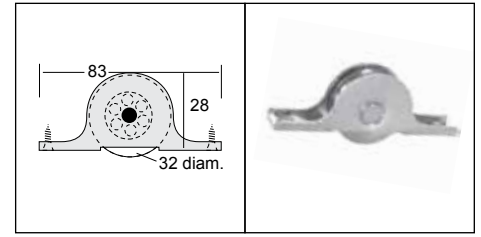

Horizon
P66100 (Pack of 2) Concave
(Nylon tyre) Max. 30kg each

P67100 (Pack of 2) Concave
(Steel tyre) Max. 60kg each

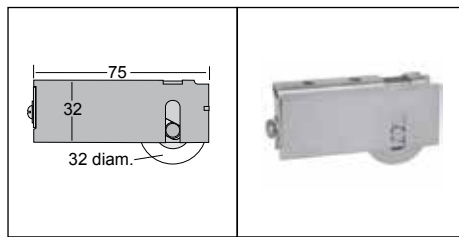

Coastline Concave Wheel
All Stainless Steel
TT66500 - Max. 50kg each

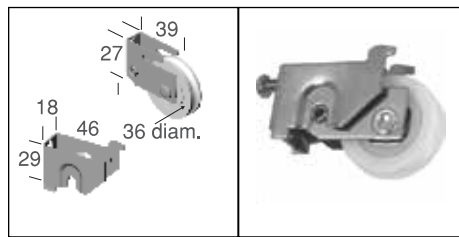

Concave Wheel Sheave & Bracket
for Sliding Door
S94900 - Max. 25kg each

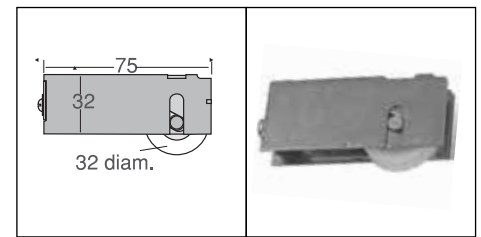

Concave Wheel Sheave
for Sliding Door
S95300 (Pack of 2) Max. 25kg each

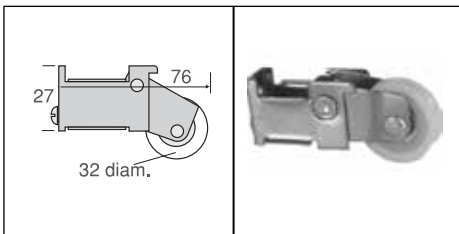

Concave Wheel Sheave
for Sliding Door
S95400 (Pack of 1) - Max. 30kg each

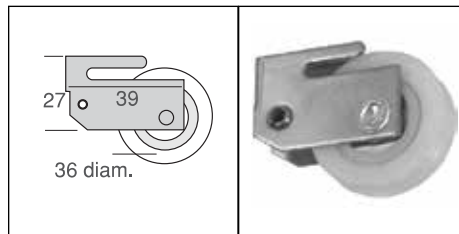

Concave Wheel Sheave
for Sliding Door
S95500 (Pack of 2) - Max. 35kg each

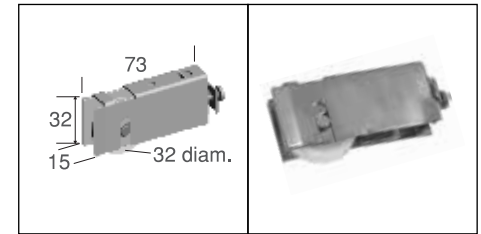

Concave Wheel Sheave
for Sliding Door
S95600 (Pack of 2) - Max. 25kg each

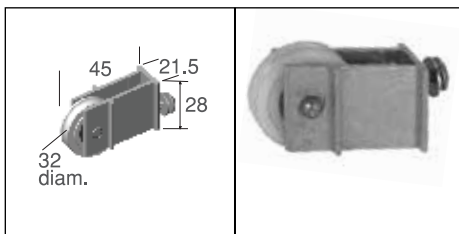

Concave Wheel Sheave
for Sliding Door
S95800 (Pack of 1) - Max. 25kg each

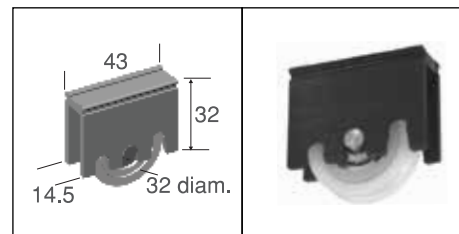

Concave Wheel Sheave
for Sliding Door
S96200 (Pack of 1) - Max. 25kg each

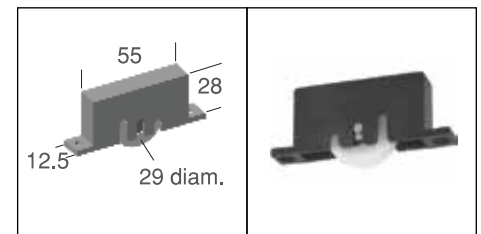

Concave Wheel Sheave
for Sliding Door
S96400 (Pack of 1) - Max. 25kg each

MEDIUM SHEAVES - HORIZONTAL (Cont.)

* Full product codes & options refer to **page 120-121**

All wheels are nylon tyred unless stated otherwise.

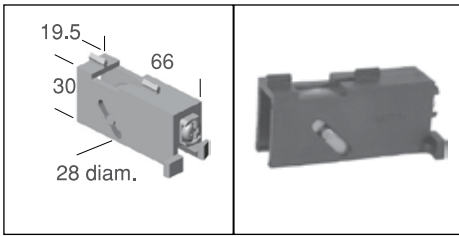

Concave Wheel Sheave for Sliding Door - R.H.
S96500 (Pack of 1) - Max. 25kg each

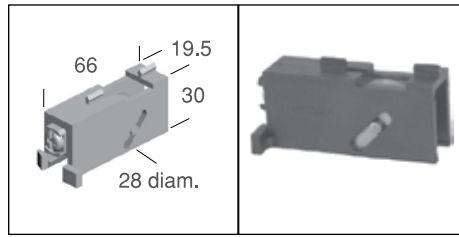

Concave Wheel Sheave for Sliding Door - L.H.
S96600 (Pack of 1) - Max. 25kg each

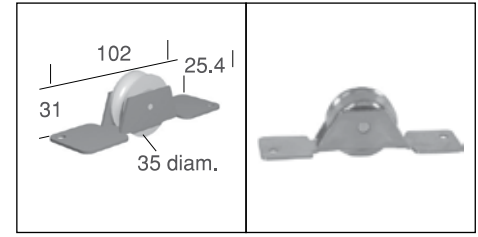

Concave Brass Wheel Sheave
for Sliding Door
S96700 (Pack of 1) - Max. 100kg each

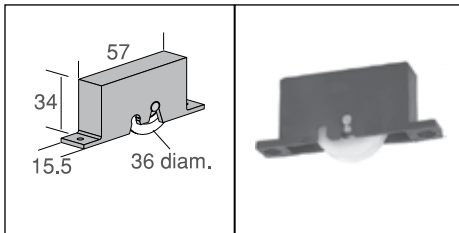

Concave Wheel Sheave
for Sliding Door
S98600 (Pack of 2) - Max. 15kg each

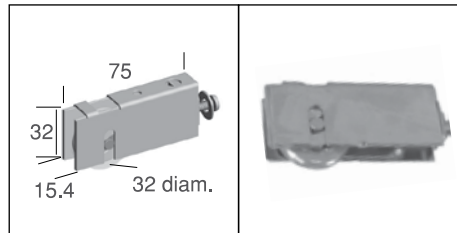

Concave Brass Wheel Sheave
for Sliding Door
S98700 (Pack of 2) - Max. 100kg each

MEDIUM SHEAVES - VERTICAL

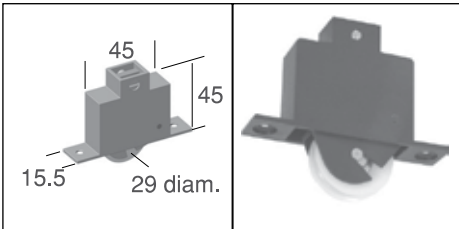

Concave Wheel Sheave
for Security/Flyscreen
S95100 (Pack of 1) - Max. 15kg each

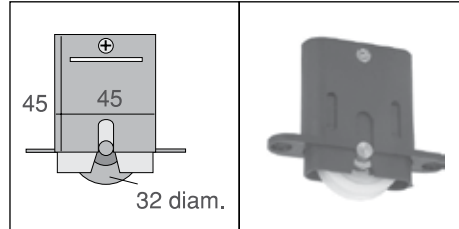

Concealed Spring Loaded Sheave
S95200 (Pack of 1) - Max. 25kg each

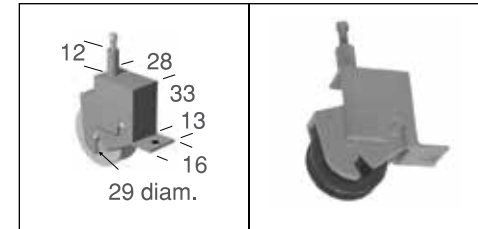

Concealed Spring Loaded Sheave
S98400 (Pack of 1) - Max. 8kg each

LARGE SHEAVES - VERTICAL

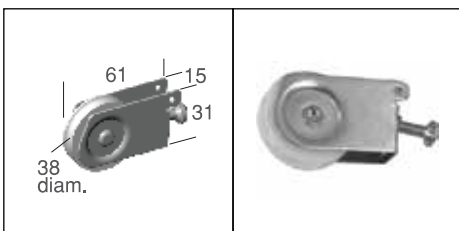

Concave Wheel Sheave
for Wardrobe Door
S95900 (Pack of 1) - Max. 20kg each

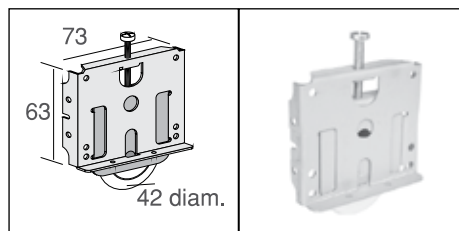

Round Wheel Sheave for Wardrobe Door
S90500 (Pack of 1) - Max. 25kg each

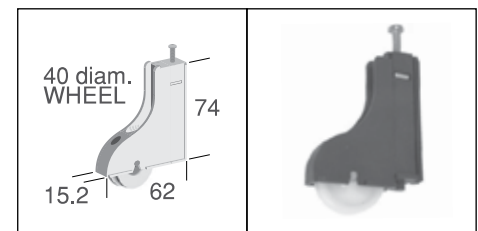

Concave Wheel Sheave for Wardrobe Door
S98300 (Pack of 1) - Max. 25kg each

REPLACEMENT WHEELS, ROLLERS AND SHEAVES

SPARE PARTS

* Full product codes & options refer to **page 120-121**

All wheels are nylon tyred unless stated otherwise.

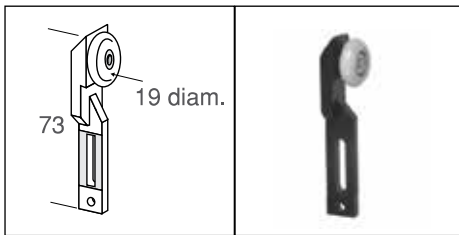

Universal Security/Flyscreen
Wheel Assembly
S96000 (Pack of 1) Max. 15kg each



Security/Flyscreen
Wheel Assembly
S96100 (Pack Set of 2) Max. 10kg each

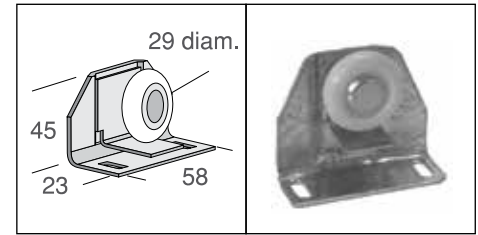

Race Assembly with Anti-Lift Bracket
S96900 (Pack of 1) Max. 30kg each

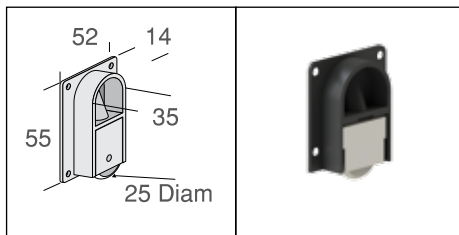

Cabinetmaker
with Round Wheel
TT18400 - Max. 10kg each

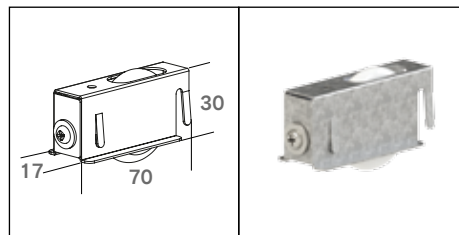

Robemaker
with Round Wheel
TT58400 - Max. 25kg each

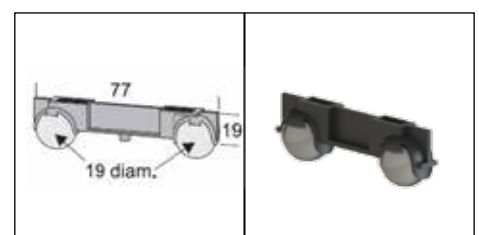

Quad-Ball Carrier Assembly Pack
P75500 (Pack of 2) - Max. 25kg each

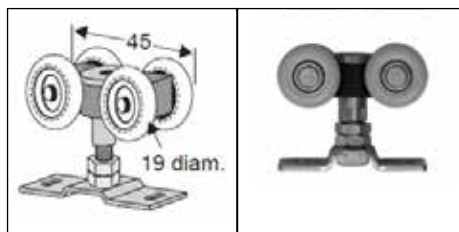

Forerunner Wheel Assembly
S33100 (Pack of 2) - Max. 34kg each

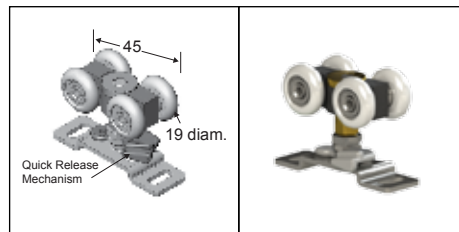

Triumph Quick Release Wheel Assembly
S33700 (Pack of 2) Max. 40kg each

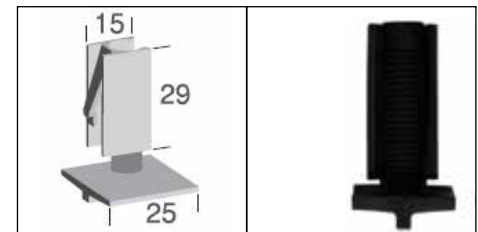

Nylon Top Hanger Guide
for Security/Flyscreen
S98800 (Pack of 2)

ADDITIONAL SPARE PARTS

P51000 (Pack of 2) Roller Bearing 10
Adjustable Wheel Assembly
50kg per door

P51500 (Pack of 2) Roller Bearing 10
Adjustable Twin Wheel Assembly
200kg per door

S96800 (Pack of 2)
Garden Shed Roller Assembly

TT19400 Cupboardline
Sliding Door Wheel Assembly
Concave Wheel
Max. 10kg each

TT21751 Glidemaster
Wheel with Axle, Nut & Washers
Max. 136kg each

TT38500 Triumph Stealth
Wheel Assembly

TT48500 Manhattan
Race Assembly - 2mm offset
Max. 25kg each

TT48600 Manhattan
Race Assembly - 12.5mm offset
Max. 25kg each

TT55000 Tudor
Wheel Assembly
Max. 10kg each

TT65000 Twin-Roll
Adjustable Wheel Assembly
Max. 60kg each
Nylon Wheel

TT65200 Twin-Roll
Adjustable Wheel Assembly
Stainless Steel Wheel
Max. 200kg each

TT65100 Twin-Roll
Steel Wheel
Max. 60kg each

S98900 (Pack of 2)
Nylon Bottom Guide
for Security/Flyscreen

AW83100 AllWeather
Sliding Door Wheel Assembly
Max. 120kg each

AW83500 AllWeather
Folding Door Wheel Assembly

* Full product codes & options refer to **page 121**

APPLICATION

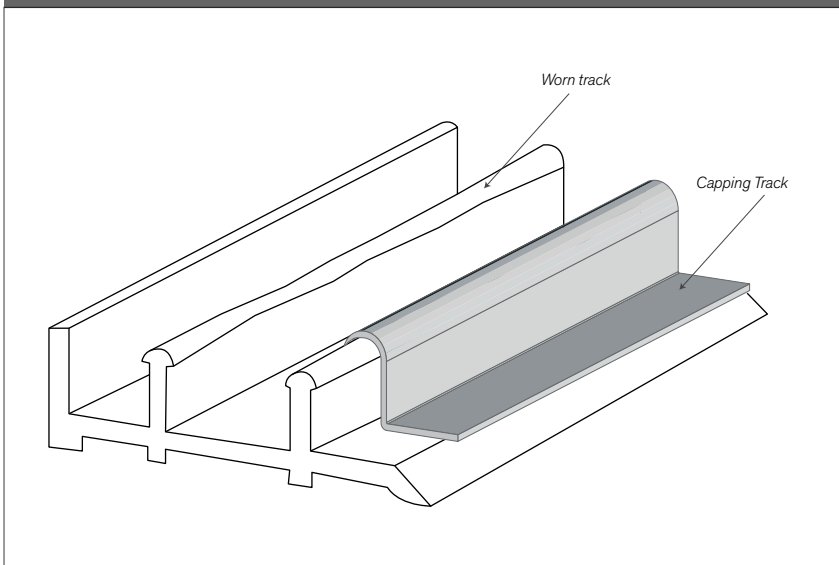

The Stainless Steel Capping Track is the inexpensive solution to those old, worn sliding door tracks. The use of a capping track is cheap, simple to install and does not require you disturbing your existing door frame.

All you do is select the capping track style which suits, cut it to size and fit it on top of your existing track.

CAPPING TRACK RANGE

- TT60100 50mm sample set of each track
- TT60200 14mm x 2.8mm radius concave wheel
- TT60300 10mm x 2.8mm radius concave wheel
- TT60400 23mm x 2.8mm radius concave wheel
- TT60500 18mm x 2.8mm radius concave wheel
- TT60600 15mm x 1.5mm radius concave wheel
- TT60700 9mm x 1.5mm radius concave wheel
- TT60800 7mm x 2.8mm radius concave wheel

RANGE

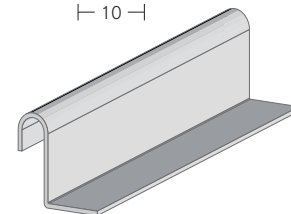
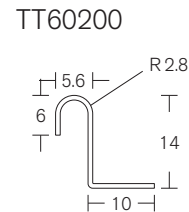
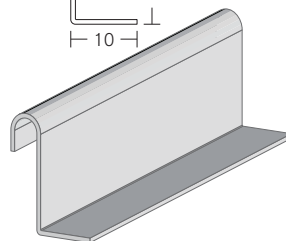
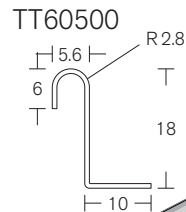
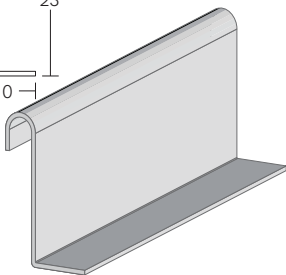
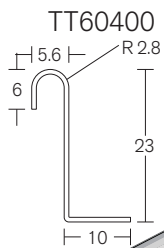

TT60300

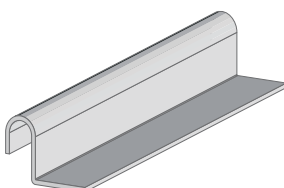
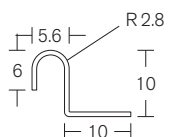

TT60800

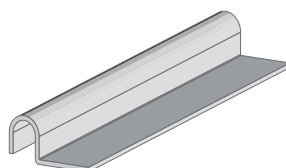
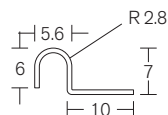

TT60600

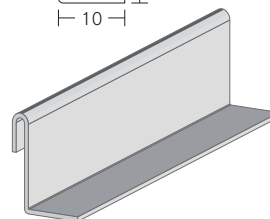
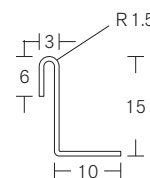

TT60700

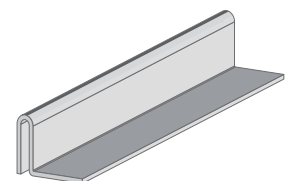
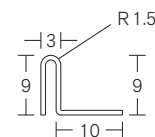

DOOR STOPS

DOOR TRACK SYSTEMS

* Full product codes & options refer to **page 121**

GENERAL PURPOSE DOOR STOP

Suitable for light and standard duty systems and
May be track, wall, floor or door mounted.
Also included in Arrow and Centurion packs.



TT64900

GLIDEMASTER RUBBER DOOR STOP

Designed specifically for use on the Glidemaster track.



TT22610

TRIUMPH CONCEALED SLIDING DOOR STOP

Designed specifically for the use in the Triumph track.
Included in packs.



TT32600

ALLWEATHER CONCEALED END STOP

Designed specifically for use in the AllWeather Sliding track.



AW82600

TRIUMPH DOOR STOP SET WITH BUMPER

Designed specifically for use in the Triumph track.



TT32100/TT37500

HEAVY DUTY DOOR STOP

Suitable for heavy duty systems and may be wall
mounted.



TT21800

INDUSTRO DOOR STOP

Designed specifically for use in the Industro track.



OM54100

QUAD BALL, FORERUNNER, TROJAN, EXPOSED 90,
BARRACUDA AND TRIUMPH FOLDING DOOR STOPS ARE
NOT AVAILABLE LOOSE.

DOOR TRACK SYSTEMS

* Full product codes & options refer to **page 121**

P20700 ADJUSTABLE DOOR GUIDE PACK

Weather pile protects surface. No need to groove door.
Fully adjustable interlocking grooves for 19mm to 38mm doors.

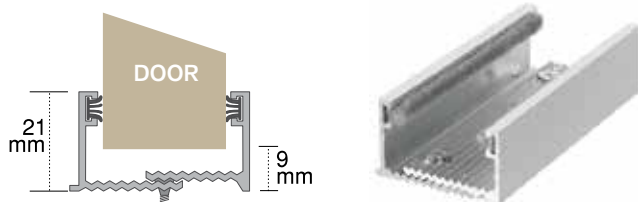

S03100 NYLON ADJUSTABLE DOOR GUIDE

(Pack of 1)

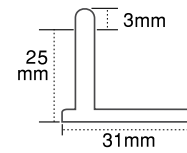

S03200 NYLON ADJUSTABLE WALL MOUNT DOOR GUIDE

(Pack of 1) Suitable for 30mm to 51mm doors.

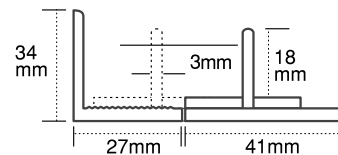

P20900 NYLON ADJUSTABLE WALL MOUNT DOOR GUIDE PACK

Guide not visible from front of door.
Fully adjustable slot for 19mm to 51mm doors.
(Incorporates the TT208 Guide + bracket)

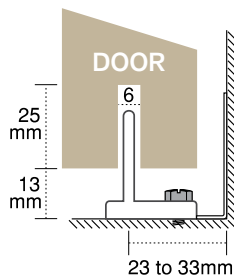

S03300 NYLON ADJUSTABLE CAVITY DOOR GUIDE

(Pack of 1) Suitable for 19mm to 35mm doors.

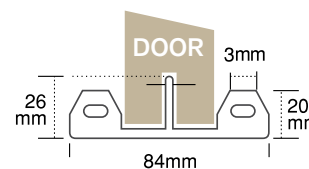

S03400 NYLON SCREEN DOOR GUIDE

(Pack of 2)

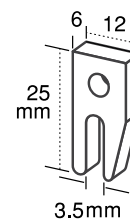

P21300 ADJUSTABLE WALL MOUNT DOOR GUIDE PACK

Weather pile protects surface. No need to the groove door.
Fully adjustable interlocking grooves for 19 to 38mm doors.

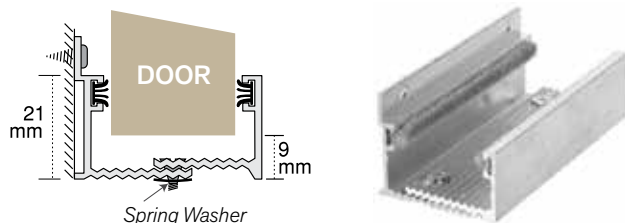

S03500 STEEL ADJUSTABLE WALL MOUNT DOOR GUIDE

(Pack of 1)

Suits 16 to 45mm Doors

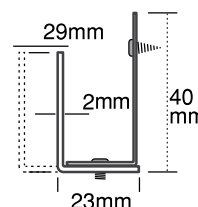

S03000 NYLON LIGHT DUTY DOOR GUIDE

(Pack of 2)

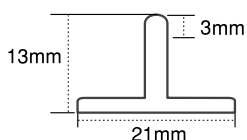

S20800 STANDARD DOOR GUIDE

(Pack of 1)

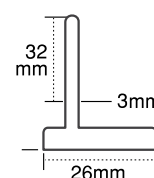

DOOR TRACK SYSTEMS

* Full product codes & options refer to **page 121**

TT208A ALUMINIUM DOOR GUIDE
 (Also available for use as a headguide)
 Available in 2500, 4500mm mill, 6000mm clear anodised undrilled & 6000mm clear anodised pre-drilled

TT66900 NYLON HEAD GUIDE BLOCK
 Used when TT208A is used as a continuous guide.

TT21600 ALUMINIUM HEAVY DUTY DOOR GUIDE 150mm

TT419 CONTINUOUS ALUMINIUM DOOR GUIDE
 (Also available for use as a headguide)
 Available in 2500 and 5000mm in Mill finish and 5000mm in Clear anodised

S31000 SPRING LOADED GUIDE
 (Pack of 2)

D32141 ALUMINIUM GUIDE CHANNEL
 Available in 4500mm Mill

S68400 NYLON CAVITY DOOR GUIDE SET
 (Set of 2)

BOTTOM DOOR GUIDE POSITIONING
 Continuous door guides may be used in any sliding door and some folding door situations but are especially recommended for multi-door openings.

Head guides are generally used when doors are bottom rolling

Bottom door guides are generally used when doors are top hung

Single door - wall mounted track

2 doors butting - wall mounted track

2 doors bi-passing - top mount track

Multiple doors bi-passing - top mount track

ALUMINIUM PELMET GUIDE

All Pelmet are optional accessories and are sold separately.

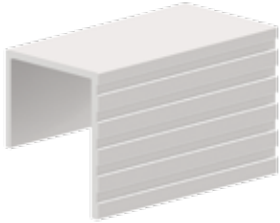

ALUMINIUM PELMET



FEATURES

- Extruded Aluminium with attractive grooved face for aesthetic appeal
- Pelmet Guide Block eliminates rattle and reduces noise
- Helps aid with weatherproofing
- Fits easily to most bottom rolling systems including the Cowdroy "Coastline", "Twin-Roll" "Timberline" and "Maxi Roller"
- Available in 6000mm clear & bronze anodised

FEATURES

- Attractive fluted design Powder Coated White
- End caps and fixing spring clips included
- Both fit easily to the Cowdroy "Arrow", "Centurion", "Quad Ball" and "Triumph" sliding door systems
- Available in sets 1830mm and 3660mm long

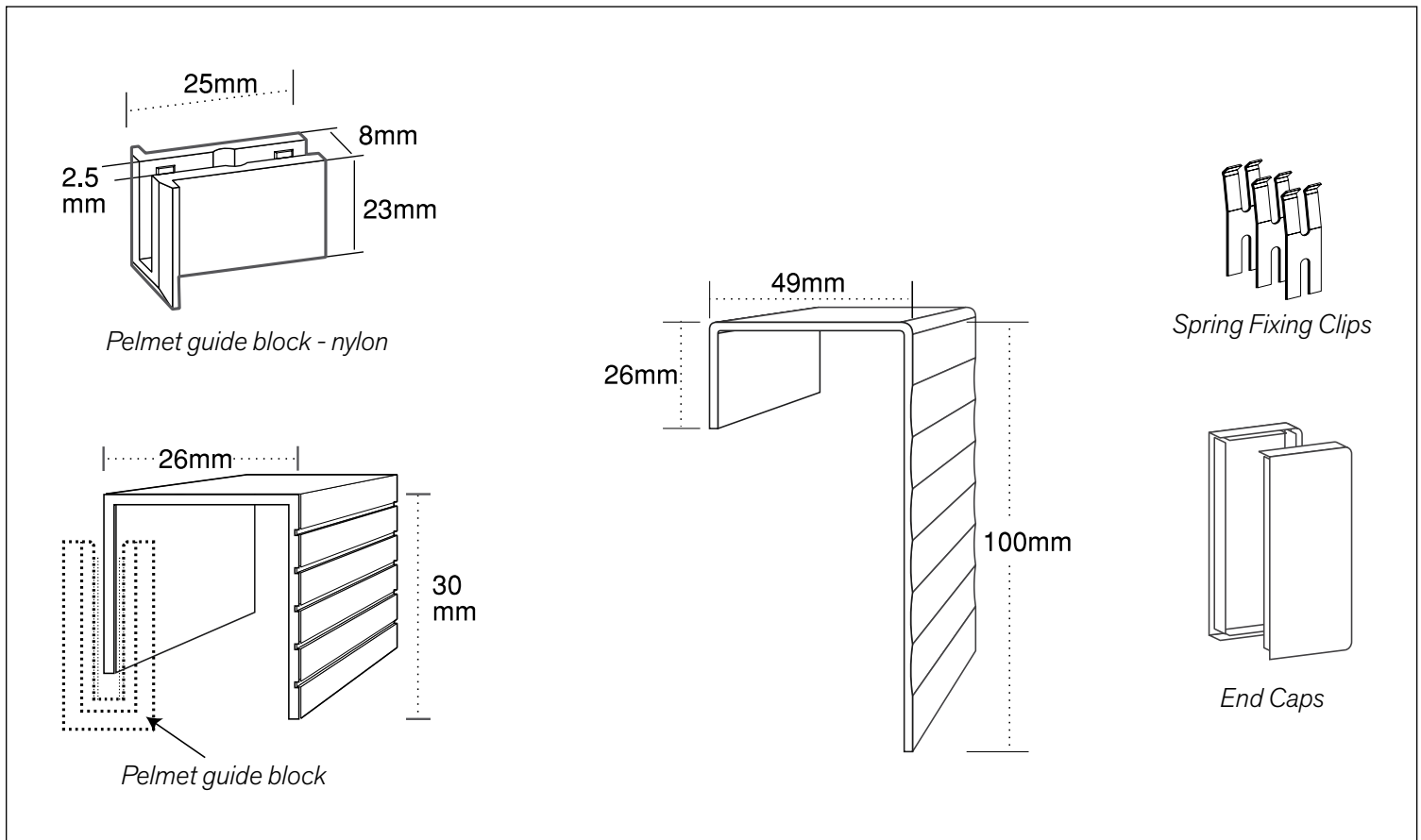

SLIDING DOOR FLUSH PULLS

* Full product codes & options refer to **page 122**

ROUNDED END

SQUARE END



FEATURES

- Suitable for all internal sliding door applications
- Includes fixing screws

METAL FLUSH PULL - ROUNDED END
128mm H x 32mm W x 9mm D

METAL FLUSH PULL - SQUARED END
113mm H x 33mm W x 10mm D

P705 Sliding door flush pull - retail pack of 2

P706 Sliding door flush pull - retail pack of 2

Available in:

Polished chrome, satin chrome

SLIDING SCREEN DOOR LATCHES

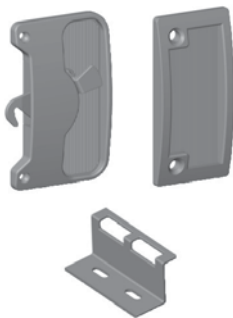

Sliding screen door latch black plastic latch with external pull, steel keeper (powder coated black) and screws. Keyless latch suitable for most sliding screen doors.

- Latched from the inside only
- Simple lever operation
- May be used in either left or right hand applications
- Includes steel keeper and fixing screws

P71600 Screen door latch - Retail pack of 1

SLIDING PATIO DOOR LOCKS



Cowdroy Sliding Patio Door Locks can be latched secure for safety. Easy to install and operate simply via the turn of a lever. Locks can be used as either right hand or left hand and can be keyed alike.

TT713 SLIDING PATIO DOOR DEADLOCK

This lock has a corrosion free polesium handle and can be latch-locked or can be dead-locked for greater security. Pin cylinder operated and is available in white, primrose and black.

P713 Patio door deadlock (pin cylinder) - Retail pack of 1

TT713 Patio door deadlock (pin cylinder) - Trade pack of 1

Available in:

Black only

CAVITY DOOR LATCHES AND PULLS

* Full product codes & options refer to **page 122**

POLARIS SLIDING CAVITY DOOR LOCKS, LATCHES AND PULLS

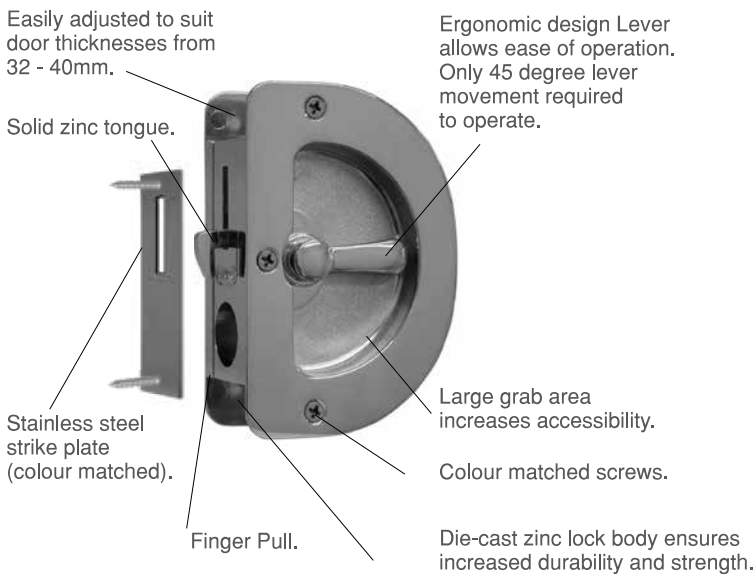

PRIVACY LATCH

The POLARIS cavity Privacy Latch is suitable for applications such as bedrooms and bathrooms where privacy is the desired function. Contains one latching lever and one emergency egress coin turn.



PASSAGE PULL

The POLARIS cavity Passage Pull is suitable for bi-parting door applications and may be used with the Privacy Latch, the Connector Latch or as a single passage pull.



CONNECTOR LATCH

The POLARIS cavity Connector Latch is suitable for all non locking applications where access is required from both sides of the door. Has a lever on each side

- P688SC Privacy latch - retail pack of 1
- P689SC Passage pull - retail pack of 1
- P690SC Connector latch - retail pack of 1

Available in: Satin chrome

CRESCENT SLIDING CAVITY DOOR LOCKS

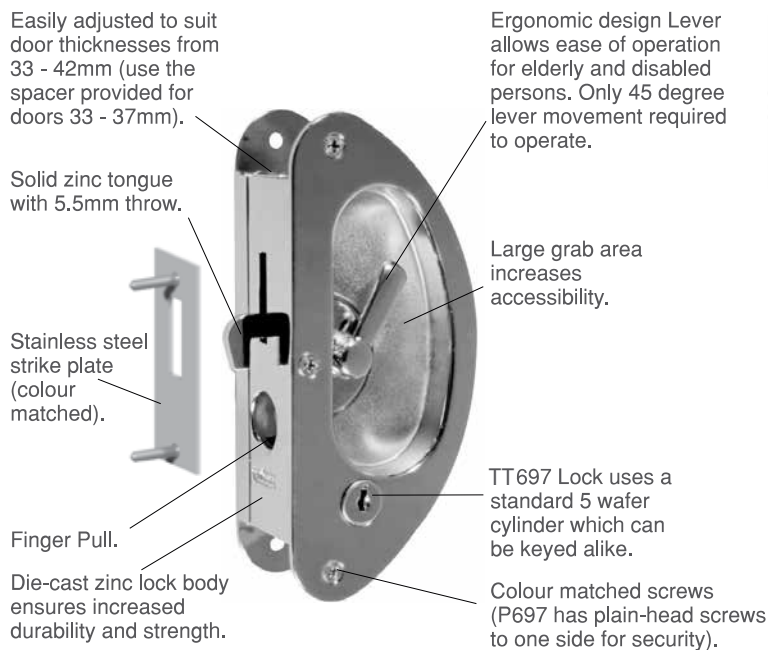

KEYED LATCH LOCK

The CRESCENT cavity keyed latch lock is suitable for applications where keyed locking is the desired function such as garage entry doors or offices. Contains two levers and two cylinders.

- TT697 Keyed Latch Lock - Trade Pack of 1

Available in: Satin chrome

FOR DOORS & DRAWERS

The Soft Close is a DIY solution designed to keep children safe from jammed fingers as well as quick and simple installation.

The product is easy to retro-fit on existing drawers and features intuitive positioning for gentle closing. Suitable for kitchens, laundries, bathrooms, wardrobes, cupboards, dressers, caravans and R.V's.

FEATURES

- Easy to retro-fit to existing drawers
- Intuitive positioning
- Gentle closing
- No slamming
- Noise reducing

BENEFITS

- No need to change existing cupboard hardware*
- Quick and simple installation
- Safe for children - no jammed fingers
- Less wear and tear
- Great in ensuites and caravans



* This range may not be compatible with your existing hardware and as such may not function correctly as a retro-fit item. Please refer to the product specifications to check whether your existing components are suitable.

FOR HINGED DOORS

* Full product codes & options refer to **page 123**

FEATURES

- Works with full overlay concealed hinges
- Designed for easy retro-fit
- Intuitive positioning - non handed
- Tool-less adjustable dampener



BT97200 Trade Bag of 10
BP97200 Retail Pack of 4

FOR TIMBER DRAWERS

FEATURES

- Works with most roller runner drawer slides
- Designed for easy retro-fit
- Intuitive positioning - non handed
- Controlled soft closing action

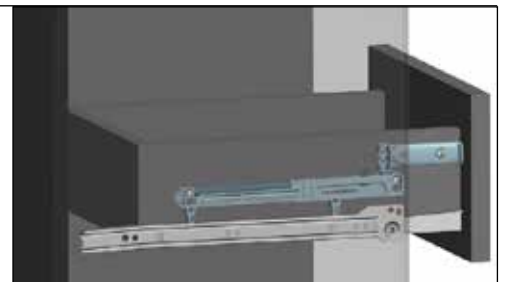

BT97300 Trade Bag of 10
BP97300 Retail Pack of 2

FOR METAL DRAWERS

FEATURES

- Works with most single skin metal box drawers on roller runner drawer slides
- Designed for easy retro-fit
- Intuitive positioning - non handed
- Controlled soft closing action

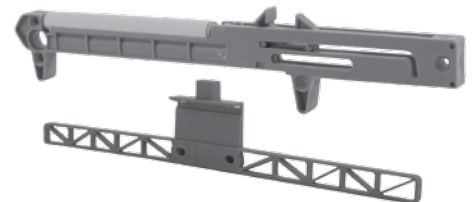
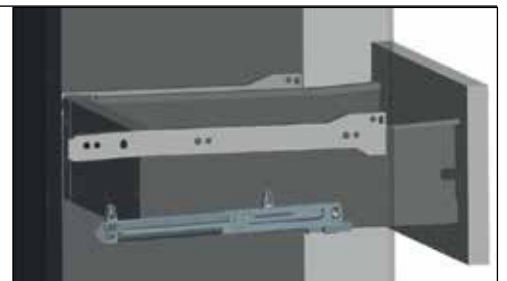

BT97310 Trade Bag of 10
BP97310 Retail Pack of 2

PUSH TO OPEN FOR HINGED DOORS & DRAWERS

FEATURES

- Works with standard concealed hinges & drawers
- Effortless one-touch opening
- Depth adjustable for consistent performance
- Concealed click-on mounting plate



BT91500 Trade Bag of 10
BP91500 Retail Pack of 4

| CODE | DESCRIPTION | SIZE | COLOUR | PAGE NO. |
|--|---|------|--------|----------------|
| REPLACEMENT WHEELS, ROLLERS AND SHEAVES | | | | 105-110 |
| S96200 | Sliding Door Concave Wheel Sheave Pack | | | |
| S96300 | Security/Flyscreen Concave Wheel Sheave Pack | | | |
| S96400 | Security/Flyscreen Concave Wheel Sheave Pack | | | |
| S96500 | Sliding Door Concave Wheel Sheave - Right Hand Pack | | | |
| S96600 | Sliding Door Concave Wheel Sheave - Left Hand Pack | | | |
| S96700 | Sliding Door Concave Brass Wheel Sheave Pack | | | |
| S96800 | Garden Shed Roller Assy Pack of 2 | | | |
| S96900 | Race Assembly with Anti-Lift Bracket Pack | | | |
| S97000 | Sliding Window 16 mm Concave Wheel Pack of 2 | | | |
| S97200 | Roller Bearing Concave Wheel Sheave Pack of 2 | | | |
| S97400 | Sliding Window Concave Wheel Sheave Pack of 2 | | | |
| S97600 | Sliding Window Concave Wheel Sheave Set Pack | | | |
| S97800 | Sliding Window Concave Wheel Sheave Pack of 2 | | | |
| S97900 | Sliding Window Concave Wheel Sheave Pack of 2 | | | |
| S98000 | Sliding Window Concave Wheel Sheave Pack of 2 | | | |
| S98300 | Wardrobe Door Concave Wheel Sheave Pack | | | |
| S98400 | Concave Wheel Spring Loaded Sheave Pack | | | |
| S98500 | Security/Flyscreen Concave Wheel Sheave Pack of 2 | | | |
| S98600 | Wardrobe Door Concave Wheel Sheave Pack of 2 | | | |
| S98700 | Sliding Door Concave Brass Wheel Sheave Pack of 2 | | | |
| S98800 | Security/Flyscreen Nylon Top Hanger Guide Pack of 2 | | | |
| S98900 | Security/Flyscreen Nylon Bottom Guide Pack of 2 | | | |
| TT18400 | Adjustable Roller Sheave | | | |
| TT19400 | Sliding Door Concave Wheel Sheave | | | |
| TT21751 | Wheel with Axle, Nut & Washers | | | |
| TT33100 | Wheel Assembly | | | |
| TT33700 | Quick Release Wheel Assembly | | | |
| TT38500 | Wheel Assembly | | | |
| TT39600 | Double Wheel Assembly | | | |
| TT39800 | Roller Guide Assembly | | | |
| TT40000 | Sheave Block (Nylon Wheel) | | | |
| TT43000 | Adjustable Roller Sheave (TT430B) (Nylon Wheel) | | | |
| TT48500 | Race Assembly - 2mm offset | | | |
| TT48600 | Race Assembly - 12.5mm offset | | | |
| TT50000 | Adjustable Roller Sheave (TT500A) (SS Wheel) | | | |
| TT50010 | Adjustable Roller Sheave (TT500B) (Nylon Wheel) (30kg Per Door) | | | |
| TT52000 | Adjustable Roller Sheave (TT520A) (SS Wheel) | | | |
| TT55000 | Wheel Assembly | | | |
| TT58400 | Adjustable Roller Sheave | | | |
| TT65000 | Adjustable Roller Sheave (Nylon Wheel) | | | |
| TT65100 | Adjustable Roller Sheave (Steel Wheel) | | | |
| TT65200 | Adjustable Roller Sheave (SS Wheel) | | | |
| TT65500 | Sheave with Bronze Wheel | | | |
| TT65700 | Adjustable Roller Sheave with Bronze Wheel | | | |
| TT66200 | Joinery Sheave (Nylon Wheel) | | | |
| TT66300 | Joinery Sheave (SS Wheel) | | | |
| TT66500 | Adjustable Roller Sheave (SS Wheel) | | | |
| TT90200 | 19mm Round Wheel & Screw | | | |
| TT90500 | Wardrobe Door Sheave Assembly | | | |
| TT92150 | 36mm Concave Wheel with 6.4 mm Axles | | | |
| TT92450 | 32mm Concave Wheel with 6.4 mm Bore | | | |
| TT92550 | 32mm Concave Wheel with 6.4 mm Axles | | | |
| TT93150 | 19mm Wheel with 4.7 mm Bore | | | |
| TT93650 | 29mm Wheel, Nut & Washer | | | |
| TT94100 | Sliding Window Concave Wheel Sheave | | | |
| TT94800 | 25mm Concave Stainless Wheel with 4.7 mm Axles | | | |
| TT95100 | Security/Flyscreen Concave Wheel Sheave | | | |
| TT95200 | Concave Wheel Spring Loaded Sheave | | | |
| TT95350 | Sliding Door Concave Wheel Sheave | | | |

| CODE | DESCRIPTION | SIZE | COLOUR | PAGE NO. |
|-----------------------|--|--------|----------------|----------------|
| TT95400 | Sliding Door Concave Wheel Sheave | | | |
| TT95550 | Sliding Door Concave Wheel Sheave | | | |
| TT95600 | Sliding Door Concave Wheel Sheave | | | |
| TT95800 | Sliding Door Concave Wheel Sheave | | | |
| TT95900 | Wardrobe Door Concave Wheel Sheave | | | |
| TT96000 | Universal Security / Flyscreen Race Assembly | | | |
| TT96200 | Sliding Door Concave Wheel Sheave | | | |
| TT96300 | Security/Flyscreen Concave Wheel Sheave | | | |
| TT96400 | Security/Flyscreen Concave Wheel Sheave | | | |
| TT96500 | Sliding Door Concave Wheel Sheave - Right Hand | | | |
| TT96600 | Sliding Door Concave Wheel Sheave - Left Hand | | | |
| TT96700 | Sliding Door Concave Brass Wheel Sheave | | | |
| TT96900 | Race Assembly with Anti-Lift Bracket | | | |
| TT97000 | Sliding Window 16 mm Concave Wheel | | | |
| TT98300 | Wardrobe Door Concave Wheel Sheave | | | |
| TT98400 | Concave Wheel Spring Loaded Sheave | | | |
| TT98500 | Security/Flyscreen Concave Wheel Sheave | | | |
| TT98700 | sliding Door Concave Brass Wheel Sheave | | | |
| CAPPING TRACKS | | | | 111 |
| TT60100 | Sample Set | | 304 Stainless | |
| TT60200 | 14mm Track | 2440mm | 304 Stainless | |
| TT60300 | 10mm Track | 2440mm | 304 Stainless | |
| TT60400 | 23mm Track | 2440mm | 304 Stainless | |
| TT60500 | 18mm Track | 2440mm | 304 Stainless | |
| TT60600 | 15mm Track | 2440mm | 304 Stainless | |
| TT60700 | 9mm Track | 2440mm | 304 Stainless | |
| TT60800 | 7mm Track | 2440mm | 304 Stainless | |
| DOOR STOPS | | | | 112 |
| AW82600 | Concealed Nylon Door Stop | - | - | |
| OM54100 | Industro Door Stop | - | - | |
| S64900 | General Purpose Door Stop Pack | - | - | |
| TT21800 | Heavy Duty Door Stop | - | - | |
| TT22610 | Aluminium End Stop with Rubber Bumper | - | Mill | |
| TT32100 | Triumph Door Stop Bracket | - | - | |
| TT37500 | Triumph Door Stop | - | - | |
| TT64900 | General Purpose Door Stop | - | - | |
| TT67412 | Door Collector Seal | 3000mm | Clear Anodised | |
| TT67414 | Door Collector Seal | 3000mm | Clear Anodised | |
| DOOR GUIDES | | | | 113-114 |
| AW21600 | Roller Guide | - | Stainless | |
| AW84200 | End Fix Roller Guide | - | - | |
| AW84700 | Frameless Glass Door Guide | - | - | |
| D32141 | Aluminium Guide Channel | 4500mm | Mill | |
| OM55100 | Brass Roller Guide | - | - | |
| OM57111 | Galvanised Steel Guide Channel | 5800mm | - | |
| P20700 | Adjustable Door Guide Pack | - | - | |
| P20900 | Nylon Adj. Wall Mount Door Guide Pack | - | - | |
| P21300 | Adj. Wall Mount Door Guide Pack | - | - | |
| S03000 | Nylon Light Duty Door Guide Pack | - | - | |
| S03100 | Nylon Adjustable Door Guide Pack | - | - | |
| S03200 | Nylon Adj. Wall Mount Door Guide Pack | - | - | |
| S03300 | Nylon Adjustable Cavity Door Guide Pack | - | - | |
| S03400 | Nylon Screen Door Guide Pack | - | - | |
| S03500 | Steel Adj. Wall Mount Door Guide Pack | - | - | |
| S20800 | Standard Duty Door Guide Pack | - | - | |
| S31000 | Spring Loaded Guide Pack | - | - | |
| S68400 | Nylon Cavity Door Guide Set Pack | - | - | |
| TT20811 | Aluminium Headguide (TT208A) | 2500mm | Mill | |
| TT18012 | Double Headguide Channel | 4880mm | Clear Anodised | |
| TT18016 | Double Headguide Channel | 4880mm | Gloss White | |
| TT18600 | Door Guide | | | |

| CODE | DESCRIPTION | SIZE | COLOUR | PAGE NO. |
|--|---------------------------------------|--------|--------------------------|------------|
| TT20800 | Standard Duty Door Guide | - | - | |
| TT20841 | Aluminium Headguide (TT208A) | 4500mm | Mill | |
| TT20852 | Aluminium Headguide (TT208A) | 6000mm | Clear Anodised | |
| TT20872 | Aluminium Headguide (TT208A) | 6000mm | Clear Anodised (Drilled) | |
| TT21600 | Aluminium Heavy Duty Door Guide | 150mm | Mill | |
| TT41921 | Aluminium Headguide | 2500mm | Mill | |
| TT41951 | Aluminium Headguide | 5000mm | Mill | |
| TT41952 | Aluminium Headguide | 5000mm | Clear Anodised | |
| TT61742 | Alum 32 x 3 mm Flat Bar Headguide | 4000mm | Clear Anodised | |
| TT66900 | Nylon Head Guide Block | - | - | |
| TT84911 | Aluminium Guide Channel | 6000mm | Mill | |
| TT58012 | Double Headguide Channel | 5000mm | Clear Anodised | |
| TT58016 | Double Headguide Channel | 5000mm | Gloss White | |
| TT58600 | Door Guide | - | - | |
| TT59016 | Triple Headguide Channel | 5000mm | Gloss White | |
| TT68420 | Nylon Cavity Door Guide Set (LH & RH) | - | - | |
| PELMETS | | | | 115 |
| P67710 | Aluminium Pelmet Set | 1830mm | White | |
| P67720 | Aluminium Pelmet Set | 3660mm | White | |
| TT65832 | Aluminium Pelmet Guide | 6000mm | Clear Anodised | |
| TT65834 | Aluminium Pelmet Guide | 6000mm | Bronze Anodised | |
| TT65900 | Pelmet Guide Block | - | - | |
| SLIDING DOOR FLUSH PULLS | | | | 116 |
| P705PC | Rounded End Pack | - | Pol. Chrome | |
| P705SC | Rounded End Pack | - | Satin Chrome | |
| P706PC | Square End Pack | - | Pol. Chrome | |
| P706SC | Square End Pack | - | Satin Chrome | |
| FLUSH BOLTS | | | | |
| TT730SN | Flush Bolt (Rounded End) Lock Pack | 140mm | Satin Nickel | |
| TT731SN | Flush Bolt (Rounded End) Pack | 140mm | Satin Nickel | |
| TT732SN | Flush Bolt (Square End) Lock Pack | 140mm | Satin Nickel | |
| TT733SN | Flush Bolt (Square End) Pack | 140mm | Satin Nickel | |
| TT734SN | Flush Bolt Slimline Keeper for | 140 mm | Satin Nickel | |
| TT735SN | Flush Bolt (Rounded End) Lock Pack | 210mm | Satin Nickel | |
| TT736SN | Flush Bolt (Rounded End) Pack | 210mm | Satin Nickel | |
| TT737SN | Flush Bolt (Square End) Lock Pack | 210mm | Satin Nickel | |
| TT738SN | Flush Bolt (Square End) Pack | 210mm | Satin Nickel | |
| TT741SN | Flush Bolt Offset (Rounded End) Pack | 210mm | Satin Nickel | |
| TT743SN | Flush Bolt Offset (Square End) Pack | 210mm | Satin Nickel | |
| TT746SN | Flush Bolt (Rounded End) Pack | 400mm | Satin Nickel | |
| TT748SN | Flush Bolt (Square End) Pack | 400mm | Satin Nickel | |
| TT79926 | Router Bit 26mm for Flush Bolt | | | |
| TT79941 | Router Bit 41mm for Flush Bolt | | | |
| SLIDING FLYSCREEN DOOR LATCHES | | | | 116 |
| P71600 | Flyscreen Door Latch Pack | - | - | |
| SLIDING PATIO DOOR LOCKS MARK 3 | | | | 116 |
| P71308 | Patio Door Deadlock (Pin) Retail Pack | - | Black | |
| TT71308 | Patio Door Deadlock (Pin) Pack | - | Black | |
| POLARIS SLIDING CAVITY DOOR LATCHES AND PULLS | | | | 117 |
| P688SC | Privacy Latch Pack | - | Satin Chrome | |
| P689SC | Passage Pull Pack | - | Satin Chrome | |
| P690SC | Connector Latch Pack | - | Satin Chrome | |
| CRESCENT SLIDING CAVITY DOOR LOCKS, LATCHES AND PULLS | | | | 117 |
| TT697SC | Keyed Latch Lock Pack | - | Satin Chrome | |

| CODE | DESCRIPTION | SIZE | COLOUR | PAGE NO. |
|--|--------------------------------|------|--------|----------------|
| SOFT CLOSE - RETAIL REORDER CODES | | | | 118-119 |
| BP91500 | Push To Open with Linear Plate | | | |
| BP97200 | Soft Close for Hinged Door | | | |
| BP97300 | Soft Close for Timber Drawers | | | |
| BP97310 | Soft Close for Metal Drawers | | | |
| SOFT CLOSE - TRADE REORDER CODES - PACK OF 12 (NOT FOR INDIVIDUAL SALE) | | | | 118-119 |
| BT91500 | Push To Open with Linear | | | |
| BT97200 | Soft Close for Hinged Door | | | |
| BT97300 | Soft Close for Timber Drawers | | | |
| BT97310 | Soft Close for Metal Drawers | | | |



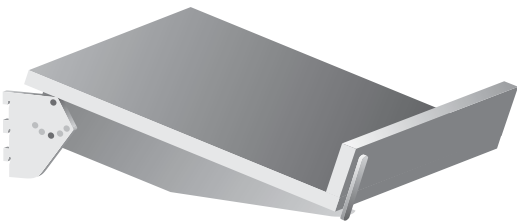

ADJUSTABLE ANGLE SHELF BRACKETS

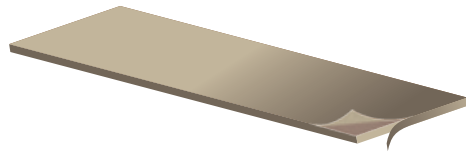

TIMBER SHELVES

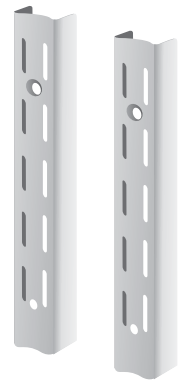

WALL STRIPPING

5. SHELVING SYSTEMS

- WALL STRIPPING
- STANDARD SHELF BRACKETS
- ADJUSTABLE ANGLE BRACKETS
- SHELF RESTS
- HANG RAIL BRACKETS
- DOUBLE SHELF BRACKETS
- TIMBER SHELVES

SHELVING SYSTEMS

* Full product codes & options refer to **page 130**

The SHELVIT shelving system is one of the most popular DIY shelving systems in Australia. The system is basically comprised of stripping, brackets, shelf rests and shelves. The stripping mounts to the wall or suitable panel and the brackets locate into the stripping to form the basis of the shelf.

WALL STRIPPING

SHELVIT stripping is manufactured from roll-formed steel, is punched in either single or double slot at 40.5mm pitch and is pre-cut to the most popular market sizes.

STOCK SIZES AND COLOURS OF STRIPPING

| Size | 600 | 900 | 1200 | 1500 | 1800 | 2100 | 2400 |
|--------|-----|-----|------|---------|---------|---------|---------|
| White | S/S | S/S | S/S | S/S&D/S | S/S&D/S | S/S&D/S | S/S&D/S |
| Chrome | S/S | S/S | S/S | S/S&D/S | S/S&D/S | S/S&D/S | S/S&D/S |

S/S = Single Slot D/S = Double Slot
Grooved Wall Bracket Adaptors also available.

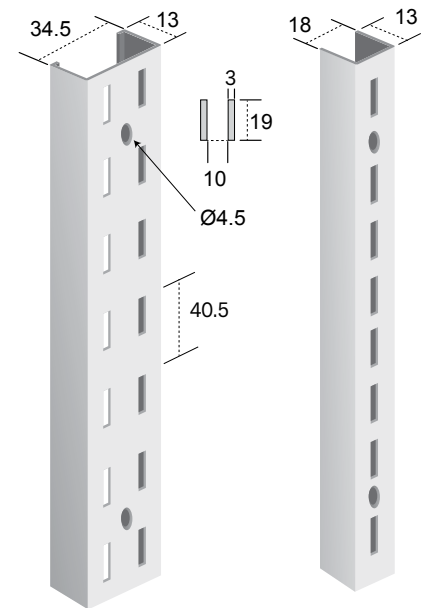

STANDARD SHELF BRACKETS

SHELVIT brackets are made from **punched steel** and incorporate unique self-locking bracket lugs which hold the brackets firmly in the stripping while minimising the lateral shelf movement.

The brackets are made using a 40.5mm pitch (distance between lugs), which is the most common pitch used in Australia. A variety of standard sizes ensures that they are suitable for most decors.

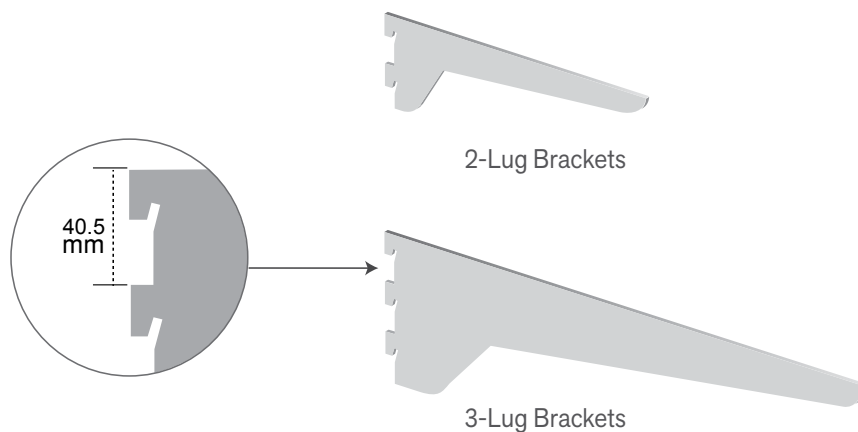

RECOMMENDED WEIGHT LOADINGS

| Bracket Size | Max. Load |
|--------------|-------------------|
| 150mm | 90 kg per bracket |
| 200mm | 70 kg per bracket |
| 250mm | 60 kg per bracket |
| 300mm | 60 kg per bracket |
| 350mm | 80 kg per bracket |
| 400mm | 75 kg per bracket |
| 450mm | 60 kg per bracket |
| 500mm | 45 kg per bracket |

The recommended maximum loads are based upon a failure point of bracket to wallstrip, not wallstrip to wall.

Loadings are assumed to be static loads spread evenly over the entire shelf.

Stock Sizes and Colours of Stripping

| Size | 150 | 200 | 250 | 300 | 350 | 400 | 450 | 500 |
|--------|-----|-----|-----|-----|-----|-----|-----|-----|
| White | 2/L | 2/L | 2/L | 2/L | 3/L | 3/L | 3/L | 3/L |
| Chrome | 2/L | 2/L | 2/L | 2/L | 3/L | 3/L | 3/L | 3/L |

2/L = 2 Lug 3/L = 3 Lug

OTHER BRACKETS

* Full product codes & options refer to **page 130**

As well as the standard SHELVIT brackets, there are special purpose brackets for angled shelves and hang rails. These brackets are made to work basically the same as the standard brackets.

ADJUSTABLE ANGLE SHELF BRACKETS

These brackets are often used where angled shelves are required. They are made in two parts, a lugged backplate and a bracket blade, are rivetted together and are held on the angle by a wingnut and screw.

The backplates come in 2-lug for sizes from 150mm to 300mm and in 3-lug from 350mm to 450mm.

The bracket blade has 2 shelf rest locating cut-outs and a cut out for the optional tilt tips. The five angle settings, ranging from horizontal to 70° (in 17.5° increments), allow for versatility in product display.

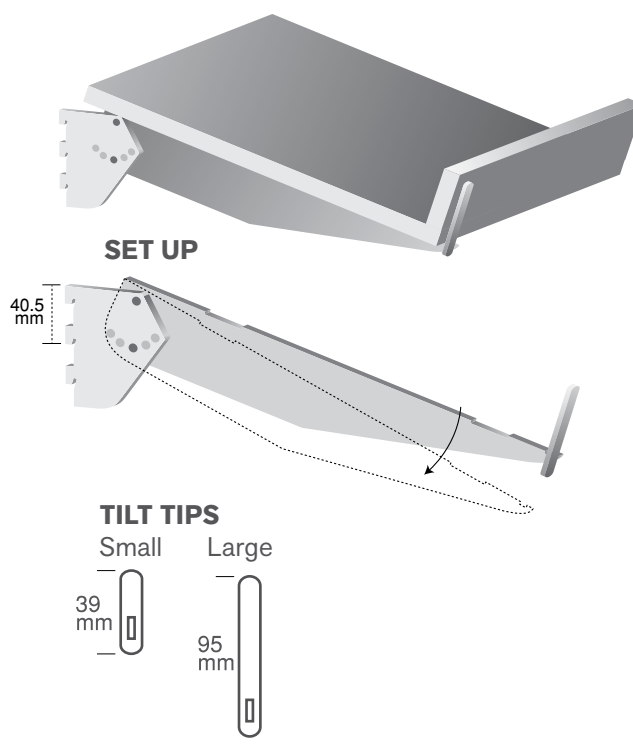

HANG RAIL (RING) BRACKETS

These brackets are used to hold a hanging rail (25mm O.D. tube) which is to support items such as coat hangers. The brackets are standard 3-lug type in 280mm and 350mm and have a ring welded to the tip.

This ring will accept up to a 25mm diameter tube and has a thumb screw tapped into one side for stabilisation.

FULL RANGE OF TUBE AVAILABLE ON REQUEST

Hang Rail (Ring) Brackets

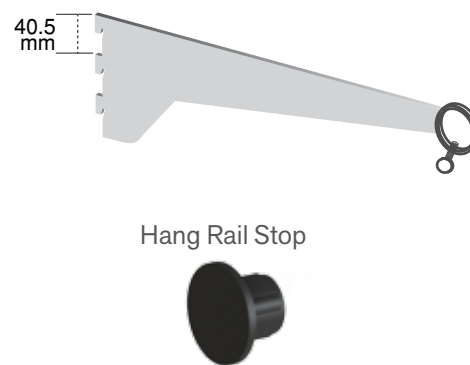

Hang Rail Stop

Stock Sizes and Colours of the Brackets & Tube

| Size | 150 | 200 | 250 | 280 | 300 | 350 | 400 | 450 |
|--------|-----|-----|-----|-----|-----|-------|-----|-----|
| White | A | A | A | R | A | A & R | A | A |
| Chrome | A | A | A | R | A | A & R | A | A |

A = Adjustable Angle Bracket
R = Hang Rail Ring Bracket

SHELF RESTS

Optional plastic shelf rests can be used with either glass or timber shelves to reduce movement.

The rubber “grommet” helps minimise movement of glass shelves but may also be removed to allow for screwing to a timber shelf.

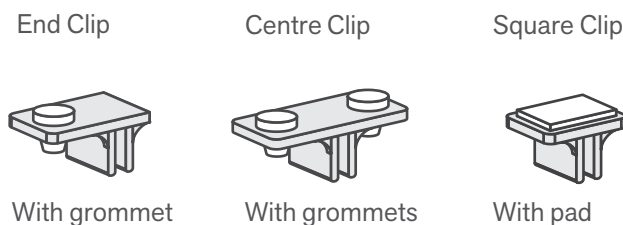

With grommet

With grommets

With pad

WALL STRIPPING AND DOUBLE SHELF BRACKETS 31.7MM PITCH

A sturdy, stable and simple to install shelving range. Made from powder coated steel. Popular 31.7mm retail slot pitch. Double slotted wall stripping with sunken face for added aesthetics. Slimline shelf brackets with double lugs for increased strength. Durable melamine timber shelves in sizes to suit.

| DESCRIPTION | COLOUR |
|----------------------------------|--------|
| Double Wall Stripping 420mm | White |
| Double Wall Stripping 710mm | White |
| Double Wall Stripping 990mm | White |
| Double Wall Stripping 1400mm | White |
| Double Shelf Bracket 2-lug 130mm | White |
| Double Shelf Bracket 2-lug 180mm | White |
| Double Shelf Bracket 2-lug 230mm | White |
| Double Shelf Bracket 2-lug 270mm | White |
| Double Shelf Bracket 2-lug 320mm | White |
| Double Shelf Bracket 2-lug 370mm | White |

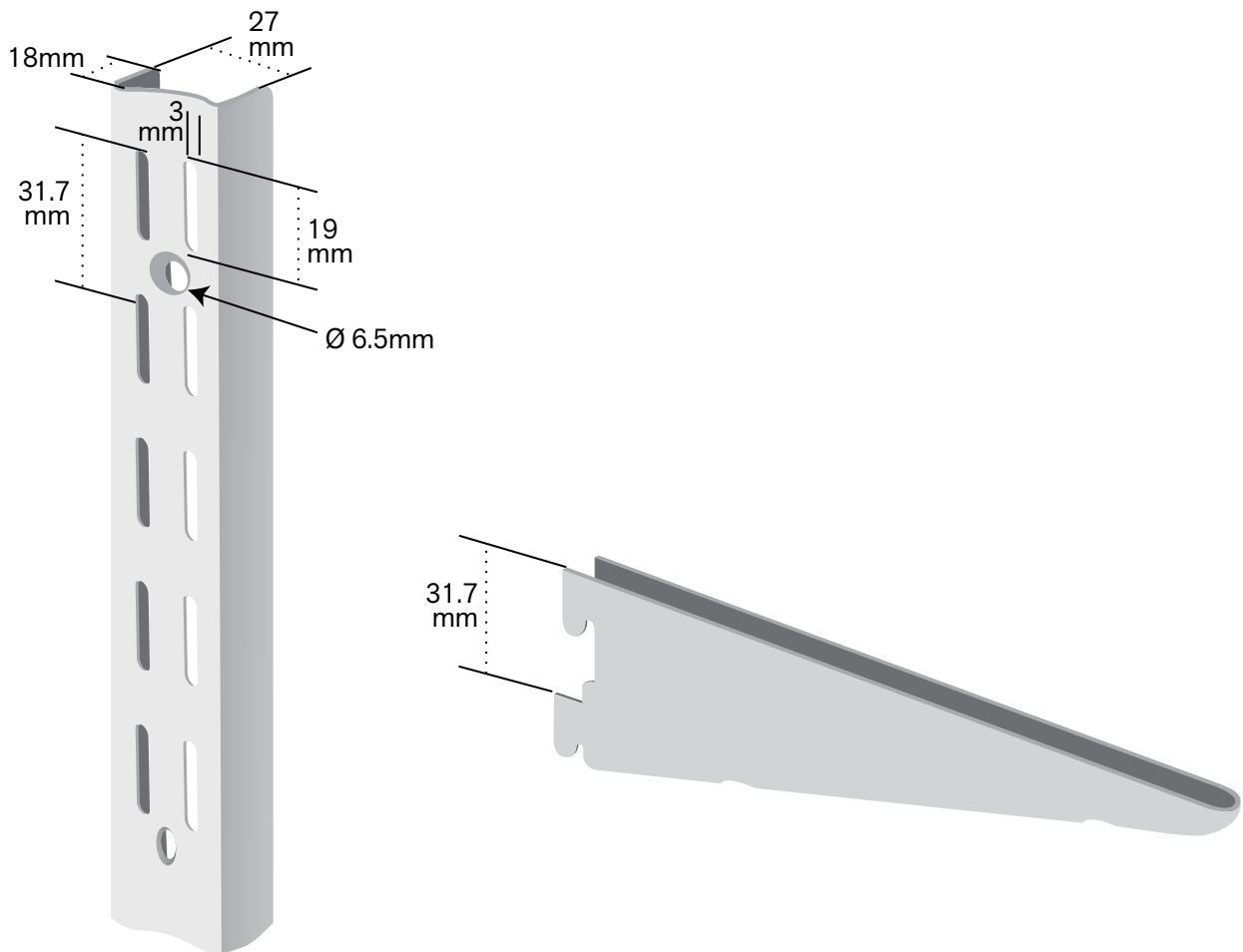

MAXIMUM LOAD 100kg per bracket
 Loadings are assumed to be static loads spread evenly over the entire shelf.

TIMBER SHELVES

The SHELVIT system can be complimented by our range of timber shelves. These 16mm shelves are manufactured from pineboard and are finished in a coloured melamine.

Shelves are stocked in 600mm, 900mm & 1200mm wide x 150, 200, 250 & 300mm deep and are available in white.

| TIMBER SHELF STOCK SIZES | | |
|--------------------------|-------------|--------------|
| 600 x 150mm | 900 x 150mm | 1200 x 150mm |
| 600 x 200mm | 900 x 200mm | 1200 x 200mm |
| 600 x 250mm | 900 x 250mm | 1200 x 250mm |
| 600 x 300mm | 900 x 300mm | 1200 x 300mm |

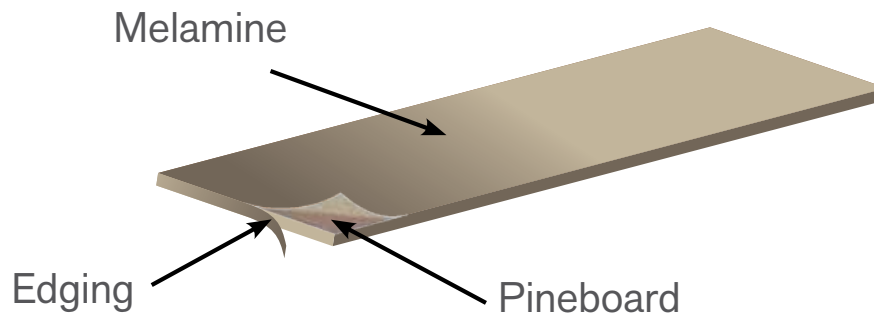

EASY TO FIX

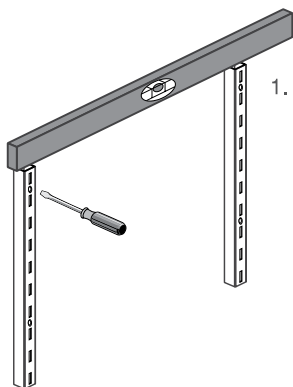

1. Fix stripping to wall ensuring that they are vertical and level. Check that all stripping is the same way up. ie. Check that slots are in line.

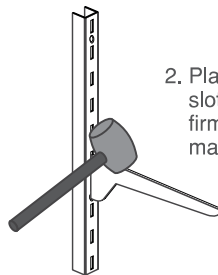

2. Place brackets into slots and knock down firmly with a rubber mallet to lock into place.

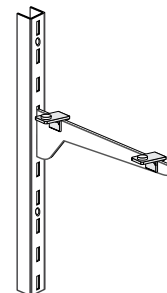

3. Fit plastic clips to front & rear of each bracket and place shelf into position. For timber shelves rubber grommets may be removed and replaced by screws.



| CODE | DESCRIPTION | SIZE | COLOUR | PAGE NO. |
|------------------|---|--------|-------------|-----------------|
| STRIPPING | | | | 126, 128 |
| SB11916 | Single Slot 40.5 mm Pitch | 600mm | White | |
| SB11917 | Single Slot 40.5 mm Pitch | 600mm | Chrome | |
| SB11926 | Single Slot 40.5 mm Pitch | 900mm | White | |
| SB11927 | Single Slot 40.5 mm Pitch | 900mm | Chrome | |
| SB11936 | Single Slot 40.5 mm Pitch | 1200mm | White | |
| SB11937 | Single Slot 40.5 mm Pitch | 1200mm | Chrome | |
| SB11946 | Single Slot 40.5 mm Pitch | 1500mm | White | |
| SB11947 | Single Slot 40.5 mm Pitch | 1500mm | Chrome | |
| SB11956 | Single Slot 40.5 mm Pitch | 1800mm | White | |
| SB11957 | Single Slot 40.5 mm Pitch | 1800mm | Chrome | |
| SB11966 | Single Slot 40.5 mm Pitch | 2100mm | White | |
| SB11967 | Single Slot 40.5 mm Pitch | 2100mm | Chrome | |
| SB11976 | Single Slot 40.5 mm Pitch | 2400mm | White | |
| SB11977 | Single Slot 40.5 mm Pitch | 2400mm | Chrome | |
| SB13216 | Double Slot 40.5 mm Pitch | 1800mm | White (DS) | |
| SB13217 | Double Slot 40.5 mm Pitch | 1800mm | Chrome (DS) | |
| SB13226 | Double Slot 40.5 mm Pitch | 2100mm | White (DS) | |
| SB13227 | Double Slot 40.5 mm Pitch | 2100mm | Chrome (DS) | |
| SB13236 | Double Slot 40.5 mm Pitch | 2400mm | White (DS) | |
| SB13237 | Double Slot 40.5 mm Pitch | 2400mm | Chrome (DS) | |
| SB13116 | Double Slot 31.7 mm Pitch | 420mm | White (DS) | |
| SB13126 | Double Slot 31.7 mm Pitch | 710mm | White (DS) | |
| SB13136 | Double Slot 31.7 mm Pitch | 990mm | White (DS) | |
| SB13156 | Double Slot 31.7 mm Pitch | 1400mm | White (DS) | |
| SB13166 | Double Slot 31.7 mm Pitch | 1980mm | White (DS) | |
| SB15171 | Alum. Concealed Single Slot 40.5 mm Pitch | 2400mm | Mill | |
| SB15191 | Alum. Concealed Single Slot 40.5 mm Pitch | 3000mm | Mill | |
| SB15271 | Alum. Concealed Double Slot 40.5 mm Pitch | 2400mm | Mill (DS) | |
| SB15291 | Alum. Concealed Double Slot 40.5 mm Pitch | 3000mm | Mill (DS) | |

| SHELVIT STANDARD SHELF BRACKETS | | | | 126 |
|--|------------------------------|-------|------------|------------|
| SB20016 | Standard 2 Lug 40.5 mm Pitch | 150mm | White | |
| SB20017 | Standard 2 Lug 40.5 mm Pitch | 150mm | Chrome | |
| SB20026 | Standard 2 Lug 40.5 mm Pitch | 200mm | White | |
| SB20027 | Standard 2 Lug 40.5 mm Pitch | 200mm | Chrome | |
| SB20036 | Standard 2 Lug 40.5 mm Pitch | 250mm | White | |
| SB20037 | Standard 2 Lug 40.5 mm Pitch | 250mm | Chrome | |
| SB20046 | Standard 2 Lug 40.5 mm Pitch | 300mm | White | |
| SB20047 | Standard 2 Lug 40.5 mm Pitch | 300mm | Chrome | |
| SB20056 | Standard 3 Lug 40.5 mm Pitch | 350mm | White | |
| SB20057 | Standard 3 Lug 40.5 mm Pitch | 350mm | Chrome | |
| SB20066 | Standard 3 Lug 40.5 mm Pitch | 400mm | White | |
| SB20067 | Standard 3 Lug 40.5 mm Pitch | 400mm | Chrome | |
| SB20076 | Standard 3 Lug 40.5 mm Pitch | 450mm | White | |
| SB20077 | Standard 3 Lug 40.5 mm Pitch | 450mm | Chrome | |
| SB20086 | Standard 3 Lug 40.5 mm Pitch | 500mm | White | |
| SB20087 | Standard 3 Lug 40.5 mm Pitch | 500mm | Chrome | |
| SB23116 | Double 2 Lug 31.7 mm Pitch | 130mm | White (DS) | |
| SB23126 | Double 2 Lug 31.7 mm Pitch | 180mm | White (DS) | |
| SB23136 | Double 2 Lug 31.7 mm Pitch | 230mm | White (DS) | |
| SB23146 | Double 2 Lug 31.7 mm Pitch | 270mm | White (DS) | |
| SB23156 | Double 2 Lug 31.7 mm Pitch | 320mm | White (DS) | |
| SB23166 | Double 2 Lug 31.7 mm Pitch | 370mm | White (DS) | |

| SHELVIT ADJUSTABLE ANGLE SHELF BRACKETS | | | | 127 |
|--|--|-------|--------|------------|
| SG72216 | Adjustable Angle Bracket (40.5 mm Pitch) | 150mm | White | |
| SG72217 | Adjustable Angle Bracket (40.5 mm Pitch) | 150mm | Chrome | |
| SG72226 | Adjustable Angle Bracket (40.5 mm Pitch) | 200mm | White | |
| SG72227 | Adjustable Angle Bracket (40.5 mm Pitch) | 200mm | Chrome | |
| SG72236 | Adjustable Angle Bracket (40.5 mm Pitch) | 250mm | White | |

| CODE | DESCRIPTION | SIZE | COLOUR | PAGE NO. |
|---------|--|-------|--------|----------|
| SG72237 | Adjustable Angle Bracket (40.5 mm Pitch) | 250mm | Chrome | |
| SG72246 | Adjustable Angle Bracket (40.5 mm Pitch) | 300mm | White | |
| SG72247 | Adjustable Angle Bracket (40.5 mm Pitch) | 300mm | Chrome | |
| SG72256 | Adjustable Angle Bracket (40.5 mm Pitch) | 350mm | White | |
| SG72257 | Adjustable Angle Bracket (40.5 mm Pitch) | 350mm | Chrome | |
| SG72266 | Adjustable Angle Bracket (40.5 mm Pitch) | 400mm | White | |
| SG72267 | Adjustable Angle Bracket (40.5 mm Pitch) | 400mm | Chrome | |
| SG72276 | Adjustable Angle Bracket (40.5 mm Pitch) | 450mm | White | |
| SG72277 | Adjustable Angle Bracket (40.5 mm Pitch) | 450mm | Chrome | |
| SG72416 | Tilt Tips - Small | - | White | |
| SG72417 | Tilt Tips - Small | - | Chrome | |
| SG72426 | Tilt Tips - Large | - | White | |
| SG72427 | Tilt Tips - Large | - | Chrome | |

SHELVIT HANG RAIL (RING) BRACKETS 127

| | | | | |
|---------|---------------------------------------|-------|--------|--|
| SG72626 | Hang Rail (Ring) Bracket 40.5mm pitch | 280mm | White | |
| SG72627 | Hang Rail (Ring) Bracket 40.5mm pitch | 280mm | Chrome | |
| SG72636 | Hang Rail (Ring) Bracket 40.5mm pitch | 350mm | White | |
| SG72637 | Hang Rail (Ring) Bracket 40.5mm pitch | 350mm | Chrome | |
| SG72700 | Hang Rail End Stop | - | - | |

SHELVIT SHELF RESTS 127

| | | | | |
|---------|---------------------------|---|---|--|
| SB29010 | End Clip with Grommet | - | - | |
| SB29110 | Centre Clip with Grommets | - | - | |
| SB29210 | Square Clip with Pad | - | - | |
| R10100 | End Clip (No Grommet) | - | - | |
| R10200 | Centre Clip (No Grommets) | - | - | |
| R10300 | Grommets | - | - | |

SHELVIT TIMBER SHELVES 129

| | | | | |
|---------|--------------|--------------|-------|--|
| SB30616 | Timber Shelf | 600 x 150mm | White | |
| SB30626 | Timber Shelf | 600 x 200mm | White | |
| SB30636 | Timber Shelf | 600 x 250mm | White | |
| SB30646 | Timber Shelf | 600 x 300mm | White | |
| SB30916 | Timber Shelf | 900 x 150mm | White | |
| SB30926 | Timber Shelf | 900 x 200mm | White | |
| SB30936 | Timber Shelf | 900 x 250mm | White | |
| SB30946 | Timber Shelf | 900 x 300mm | White | |
| SB31216 | Timber Shelf | 1200 x 150mm | White | |
| SB31226 | Timber Shelf | 1200 x 200mm | White | |
| SB31236 | Timber Shelf | 1200 x 250mm | White | |
| SB31246 | Timber Shelf | 1200 x 300mm | White | |

GROOVED WALL (UNIWALL) BRACKET ADAPTORS

| | | | | |
|---------|---------------------------------------|---|--------|--|
| UW10006 | Bracket Adaptor 3 Slot (40.5mm Pitch) | - | White | |
| UW10007 | Bracket Adaptor 3 Slot (40.5mm Pitch) | - | Chrome | |
| UW20006 | Bracket Adaptor 2 Slot (40.5mm Pitch) | - | White | |
| UW20007 | Bracket Adaptor 2 Slot (40.5mm Pitch) | - | Chrome | |

SHELVING SYSTEMS RAILS

| | | | | |
|-------|------------------------------|--------------------|--------|--|
| 36064 | Round Tube Plate 0.7mm thick | 3.6m x 19mm | Chrome | |
| 36068 | Round Tube Plate 0.7mm thick | 3.6m x 25mm | Chrome | |
| 36069 | Oval Tube 0.7mm thick | 3.6m x 15mm x 30mm | Chrome | |
| 36078 | Towel Pillar Centre | 19mm Round | Chrome | |
| 36079 | Towel Pillar Centre | 25mm Round | Chrome | |
| 36081 | Towel Pillar End | 19mm Round | Chrome | |
| 36082 | Towel Pillar End | 25mm Round | Chrome | |
| 36085 | Towel Pillar End | 15 x 30mm Oval | Chrome | |
| 36086 | Towel Pillar Centre | 15 x 30mm Oval | Chrome | |





6. BARRIER DOORS

SUPERIOR
BIRCHGROVE
FEDERATION
PADDINGTON
HARRINGTON
BALMAIN

The Cowdroy Barrier Door range offers a selection of standard and custom built quality screen doors in a range of designs and colours that will enhance and compliment the look of your home.

** Full product codes & options refer to **page 138***

All doors come with the following:

- Heavy duty extruded aluminium frame
- Double cylinder lock with deadlocking and privacy functions
- 2 hinges per door
- 21 standard powder coat colours to choose from
- A range of popular optional accessories
- Custom made to your sizes
- Australian made
- Warranty information found on the Cowdroy website

SUPERIOR DOOR

Features a high quality and impact resistant #316 grade woven stainless steel mesh fitted inside the frame by way of a double locking wedge and an acrylic adhesive.

The "Superior" door combines strength and quality with an unobtrusive view.

BIRCHGROVE

Popular diamond grille door made to order.

PADDINGTON, FEDERATION, HARRINGTON, BALMAIN

Features a decorative cast aluminium panel fitted within the frame and finished with a quality fibreglass mesh.

There are 4 highly popular panel inserts available in the range, each of which are finished in the same durable powdercoat as the frame.

This range combines elegance with quality and will give your home a new look.

BARRIER DOOR OPTIONAL EXTRAS

✓ TRIPLE LOCK

Upgrade your lock option to an Austral EKIT triple lock for increased locking security.



✓ DOOR CLOSER

Add a pneumatic door closer to automatically return your door to its closed position.



✓ PET DOORS*

*Suitable for Superior & Birchgrove doors only

Pet doors are ideal for those with indoor pets.

Available in 3 sizes Small (190x240mm), Medium (255x305mm) & Large (260x400mm)



✓ BUG SEAL

Consider a bug seal to help keep out those unwanted pests.

All bug seals are finished in the same colour as your door.



✓ DVA MESH

For increased privacy upgrade your mesh to reduced visibility, light dependant DVA mesh.



✓ PET MESH

Protect your pet by upgrading your mesh to a pet-friendly soft mesh.



6 EASY STEPS TO SELECTING YOUR BARRIER DOOR

HERE IS HOW YOU ORDER YOUR CUSTOMER BUILT BARRIER DOOR

① BARRIER DOORS

Below is the range of Barrier Door styles.



SUPERIOR

Custom Maximum Size 2500mm x 1300mm



BIRCHGROVE

Maximum Size 2512mm x 1365mm



FEDERATION

Minimum Size 1940mm x 760mm
Maximum Size 2120mm x 920mm



PADDINGTON

Minimum Size 1950mm x 760mm
Maximum Size 2120mm x 920mm



HARRINGTON

Minimum Size 1850mm x 760mm
Maximum Size 2120mm x 920mm



BALMAIN

Minimum Size 1833mm x 760mm
Maximum Size 2120mm x 920mm

② CHOOSE COLOURS

| Door Finish | Default Lock Finish | Default Door Closer Finish (Optional) |
|-------------|--------------------------------------|---------------------------------------|
| | <input type="radio"/> White | <input type="radio"/> White |
| | <input type="radio"/> White Birch | <input type="radio"/> White Birch |
| | <input type="radio"/> Primrose | <input type="radio"/> Primrose |
| | <input type="radio"/> Black | <input type="radio"/> Black |
| | <input type="radio"/> Stone Beige | <input type="radio"/> Stone Beige |
| | <input type="radio"/> Black | <input type="radio"/> Black |
| | <input type="radio"/> Black | <input type="radio"/> Black |
| | <input type="radio"/> Black | <input type="radio"/> Black |
| | <input type="radio"/> Black | <input type="radio"/> Black |
| | <input type="radio"/> Black | <input type="radio"/> APO Grey |
| | <input type="radio"/> Black | <input type="radio"/> Black |
| | <input type="radio"/> Black | <input type="radio"/> Black |
| | <input type="radio"/> Black | <input type="radio"/> Black |
| | <input type="radio"/> Black | <input type="radio"/> Black |
| | <input type="radio"/> Black | <input type="radio"/> Black |
| | <input type="radio"/> Black | <input type="radio"/> Black |
| | <input type="radio"/> Bronze | <input type="radio"/> Bronze |
| | <input type="radio"/> Brown | <input type="radio"/> Brown |
| | <input type="radio"/> Woodland Grey | <input type="radio"/> Woodland Grey |
| | <input type="radio"/> Hawthorn Green | <input type="radio"/> Hawthorn Green |
| | <input type="radio"/> Black | <input type="radio"/> Black |

Choose any combination of door lock & closer from the above colour range.

* Full product codes & options refer to **page 138**

③ DOOR OPENING MEASUREMENTS

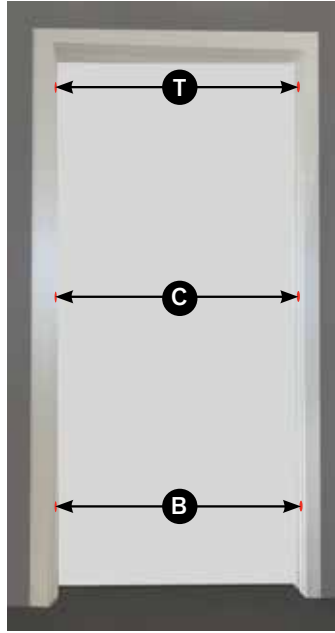
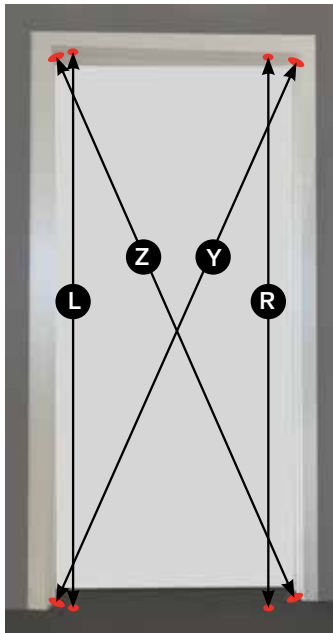

Always measure on the other side of the jamb from which the entry door sits.

HEIGHT

| | | |
|----------|----------------------|----|
| L | <input type="text"/> | mm |
| R | <input type="text"/> | mm |

DIAGONAL

| | | |
|----------|----------------------|----|
| Z | <input type="text"/> | mm |
| Y | <input type="text"/> | mm |

WIDTH

| | | | | | |
|----------|----------------------|----|----------|----------------------|----|
| T | <input type="text"/> | mm | B | <input type="text"/> | mm |
| C | <input type="text"/> | mm | | | |

④ LOCK/HANDLE

Check the space between your existing door lock and the outside face of your jamb. The gap required to ensure your new barrier door fits is minimum 20mm.

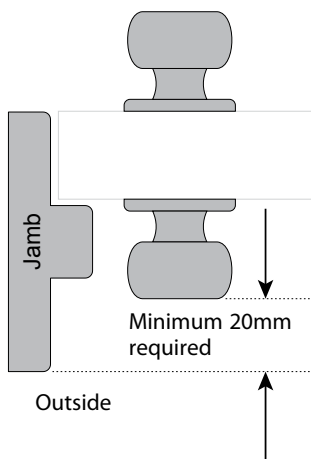

⑤ HANDLE SIDE

From the outside looking in, choose your handle side. *Usually the same side as your existing door.*



L/H Side



R/H Side

⑥ HANDLE HEIGHT

How high would you like your handle? Enter your distance from the sill up to the centre of the handle lever.

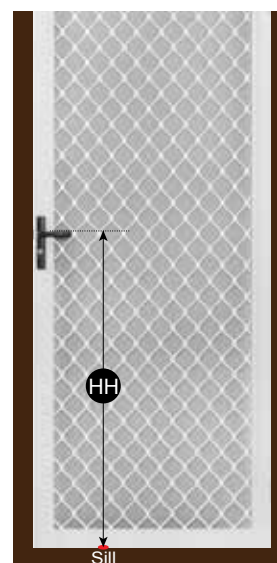

IMPORTANT
Ensure the height of the handle of your new barrier door will not collide with the handle of your existing door when closed.

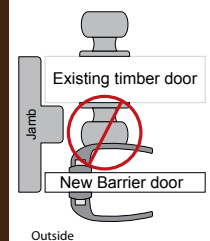

Outside

| | | |
|-----------|----------------------|----|
| HH | <input type="text"/> | mm |
|-----------|----------------------|----|

STANDARD INCLUSIONS

Using the guide to the left complete this form to order your new barrier door.
 Note: Take extra care with your measurements as your door cannot be altered once it has been made.

1. Select door type What type of door would you like?

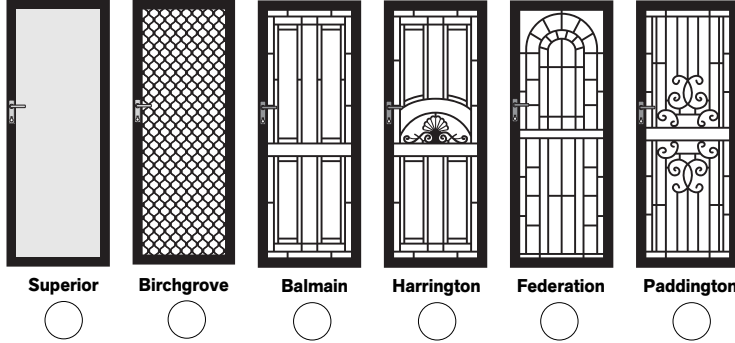

2. What colour would you like your doors from the options to the left.

3. Enter your door opening sizes in column A
 OR your make-to-size in column B

| | A Door Opening | Less | B Doors Make to Size |
|----------|--------------------------|--------------|--------------------------------|
| L | mm | -10mm | mm |
| R | mm | -10mm | mm |
| T | mm | -8mm | mm |
| C | mm | -8mm | mm |
| B | mm | -8mm | mm |

4. Select your handle colour. Available colours shown below

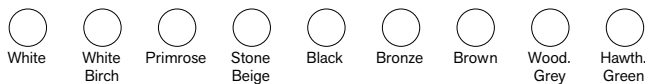

5. Select your handle side. (From the outside looking inwards)



6. Enter your handle height. (From sill to centre of handle lever)

HH mm

(NOTE: For Triple Lock option - fittings will be located at an equal distance above and below this nominated handle height)

OPTIONAL ACCESSORIES

Optional extras sold separately

A. Extra security - Triple lock

B. DVA Mesh/Privacy

Select colour

(Available colours shown below)



Not available for Superior Doors

C. Superior Steel Mesh

(Available on all doors. Included as standard for Superior Doors)

D. Paw-Proof Pet Mesh

(Not available for Superior Door)

E. Perspex Pet Door

(Available for Superior & Birchgrove Doors Only)



F. Door Closer

Select colour (Available colours shown below)

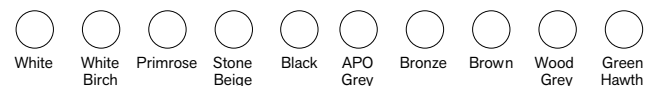

G. Bug Seal

Please email your completed form to:
 cowdroy@cowdroy.com.au

| | |
|-----------------------------|---|
| Order No. | <input style="width: 100%; height: 20px;" type="text"/> |
| Customer name | <input style="width: 100%; height: 20px;" type="text"/> |
| Customer contact No. | <input style="width: 100%; height: 20px;" type="text"/> |
| Store suburb | <input style="width: 100%; height: 20px;" type="text"/> |
| Staff member | <input style="width: 100%; height: 20px;" type="text"/> |
| Date | <input style="width: 100%; height: 20px;" type="text"/> |
| Customer Signature | <input style="width: 100%; height: 20px;" type="text"/> |

| CODE | DESCRIPTION | SIZE | COLOUR | PAGE NO. |
|--|--|---------------------------|-------------|------------|
| CUSTOM MADE DOORS | | | | 135 |
| BAR01SUP | Superior Standard | MTM up to 2500mm x 930mm | | |
| BAR02SUP | Superior Large | MTM up to 2500mm x 1300mm | | |
| BAR13COL | Federation | Made to Measure | | |
| BAR14COL | Harrington | Made to Measure | | |
| BAR34COL | Balmain | Made to Measure | | |
| BAR56COL | Paddington | Made to Measure | | |
| BAR60BIR | Birchgrove | MTM up to 2512mm x 1365mm | | |
| OPTIONAL EXTRAS (Available only with custom made doors) | | | | 134 |
| BAR901TL | Triple Lock | | | |
| BAR902DC | Door Closer | | | |
| BAR903BS | Bug Seal | | | |
| BAR904PS | Pet Door - Small (Superior & Birchgrove ONLY) | | | |
| BAR905PM | Pet Door - Medium (Superior & Birchgrove ONLY) | | | |
| BAR906PL | Pet Door - Large (Superior & Birchgrove ONLY) | | | |
| BAR907MP | Mesh - Pet Mesh (Excl. Superior) | | | |
| BAR908MD | Mesh - DVA Mesh (Excl. Superior) | | | |
| BAR909MS | Mesh - Stainless Steel (Excl. Superior - Comes standard with Superior) | | | |
| STOCK DOORS | | | | 135 |
| BAR01SUPBK | Superior Stock | 2032mm x 813mm | Black | |
| BAR01SUPBW | Superior Stock | 2032mm x 813mm | Birch White | |
| BAR01SUPPR | Superior Stock | 2032mm x 813mm | Primrose | |
| BAR01SUPWH | Superior Stock | 2032mm x 813mm | White | |
| BAR60BIRBK | Birchgrove Stock | 2032mm x 813mm | Black | |
| BAR60BIRBW | Birchgrove Stock | 2032mm x 813mm | Birch White | |
| BAR60BIRPR | Birchgrove Stock | 2032mm x 813mm | Primrose | |
| BAR60BIRWH | Birchgrove Stock | 2032mm x 813mm | White | |



For all warranty information and terms and conditions, please refer to cowdroy.com.au or contact us on 1800 COWDROY (1800 269 376).

H.M. Cowdroy Pty Ltd. Head Office Sydney

38 Redfern St, Wetherill Park, NSW 2164 Australia

Phone: +61 (2) 9604 3000

Fax: +61 (2) 9604 8129

Sales fax: +61 (2) 9609 3694

Website: www.cowdroy.com.au

Email: sales@cowdroy.com.au

National Call: 1800 COWDROY (1800 269 376)

H.M. Cowdroy Pty Ltd. ABN 47 000 033 947

Cowdroy is an Australian company supplying industry leading door and window hardware to retail, trade and architectural outlets.

Established in 1890, Cowdroy specialises in door tracking systems, window and door

seals, replacement wheels & rollers, sliding glass cabinet tracking systems and door hardware.

For all our product information visit the Cowdroy website at: www.cowdroy.com.au

HEAD OFFICE SYDNEY

38 Redfern St
Wetherill Park, NSW 2164
Phone: (02) 9604 3000
Fax: (02) 9604 8129
Sales Fax: (02) 9609 3694

WEBSITE

www.cowdroy.com.au

EMAIL

sales@cowdroy.com.au

NATIONAL CALL

1800 COWDROY (1800 269 376)

Melbourne

U1 / 34-36 Deans Court
Dandenong South, VIC 3175
Ph: 1800 269 376
Fax: (03) 9791 6759

Auckland NZ

18 Kerwyn Ave, East Tamaki
Auckland 2013
Phone: (09) 274 7279
Fax: (09) 274 4453

Perth

2 Meares Way
Canning Vale, WA 6155
Ph: (08) 9455 5354
Fax: (08) 9455 5461

Christchurch NZ

56 Treffers Road, Sockburn
Christchurch 8042
Phone: (03) 943 2060
Fax: (03) 943 2061

Launceston

ACCESS HARDWARE Pty Ltd.
Goodman Cres., Invermay 7248
Ph: (03) 6324 4900
Fax: (03) 6324 4901

Adelaide

Unit 2/52 Wodonga St
Beverley, SA 5009
Ph: 1800 269 376
Fax: (02) 9604 8129

Brisbane

U1 / 90 Pritchard Rd
Virginia, QLD 4014
Ph: (07) 3265 3311
Fax: (07) 3265 3733

Townsville

U1/42 Carmel St,
Garbutt, QLD 4814
Ph: (07) 4779 5122
Fax: (07) 4725 5495

cowdroy



**ALCHIN
LONG
GROUP**

