

Nero® Collection



We take the worry out of
protecting what's valuable to you.
Lockwood: *no worries*®

25YEAR MECHANICAL
WARRANTY

LOCKWOOD

ASSA ABLOY

www.lockweb.com.au

NERO[®]

COLLECTION



Master the Mood
with Lockwood

*The Lockwood Nero Collection provides a sensuous
quality that complements contemporary décor;
adding a defining design element to any space.*

Contents



143
Entrance Handle
page 4



Velocity® Large Rose
Element Lever
page 6



Velocity® Small Rose
Leversets
page 9



Velocity® Small Rose
Escutcheons
page 13



Cavity Sliding
Door Lock
page 15



FP2
Flush Pull
page 17



724 Series
Slide Arm Door Closer
page 19



Nexion® Mechanical
Entrance Lockset
page 21



Paradigm® 005
Double Cylinder Deadbolt
page 25

143 Entrance Handle



The Lockwood 143 Entrance Handle is constructed using the finest materials to incorporate the maximum standards in style, durability, finish and design.

Style and Variety

Combining fit for purpose with the epitome of style, the Lockwood 143 Entrance Handle offers a high quality solution to the requirements of both residential and commercial markets.

Packaging For Various Doors

Comes supplied with spigots to suit 10 – 12mm thick glass doors as well as aluminium and timber doors up to 50mm thick.

Application

Suitable for use on timber or aluminium frame as well as glass doors; making them the ideal choice for commercial, industrial and residential applications.

Multi Fix - timber, aluminium or glass doors

Product Details

Materials

Stainless Steel Construction: Constructed of 304 grade stainless steel, suitable for use in external environments

Standards and Compliance



Disabled Access - AS1428.1

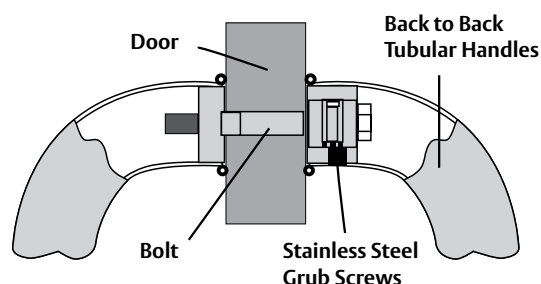

143 Entrance Handle

143 Entrance Handle

Part Number 143X600MBK

Fixing

Timber 2 x 62mm M6 Bolts - 8.5mm hole

Glass 2 x 32mm M6 Bolts - 13mm hole



Disabled Accessible AS1428.1

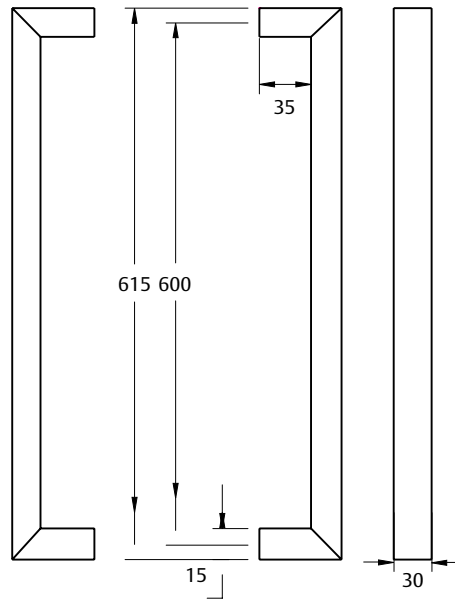

Velocity® Series Large Rose Door Furniture



The Velocity Series is a stylish range of door furniture suitable for use in residential dwellings.

Designed to suit common door preparations in the Australian market, Velocity is ideal for both new and retrofit applications.

Retrofitable

Fits majority of doors with 54mm hole.

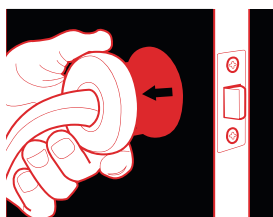

1 Align **2 Twist** **3 Tighten**



Features and Specifications

- All fixings are concealed beneath a removable rose trim providing a crisp and clean presentation desired by the discerning home owner
- Simple twist and tighten fixing method with pre-assembled lever set allows for super easy and fast installation
- The rose fits 50mm or 54mm diameter holes making it suitable for retrofit and common door preparations
- Designed in Australia for the specific needs of the Australian market

Product Details

Rose Dimensions 63mm by 12.5mm.

Materials Solid zinc die-cast with steel rose trims

Latches Passage sets are available with a 60mm backset tubular latch. Privacy sets are supplied with a 60mm backset privacy latch which includes an activating pin for the inside of the door and an external emergency release function. The latch is automatically released when the internal handle is operated and is easily adapted for both open in and open out applications. All latches are supplied with industry standard "D" strikes.

Door Thickness 32mm to 45mm hinged doors

Finishes Matt Black (MBK)

Standards and Compliance

D5 Tested to AS4145.2 2008 for Durability passing D5 - 100,000 cycles.



Tested to AS4145.2 2008 for Neutral Salt Spray, passing C6 - 168 hours.

Not suited to coastal applications

Velocity® Series Large Rose Door Furniture

Element™ – Lever 3

Length	122mm
Projection	54.5mm
Finger Clearance	47.5mm

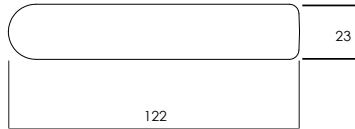
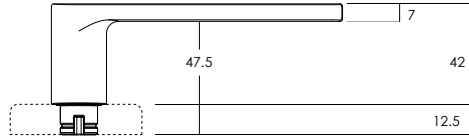

Passage Leverset

Part Number	VEL1/L3MBK
--------------------	------------

Dummy Lever

Part Number	VEL3/L3MBK
--------------------	------------

Privacy Leverset

Part Number	VEL2/L3MBK
--------------------	------------



Velocity® Series Large Rose Door Furniture

Square Rose Passage Trim

Part Number VES1-TRIMMBK

* Pack of 2

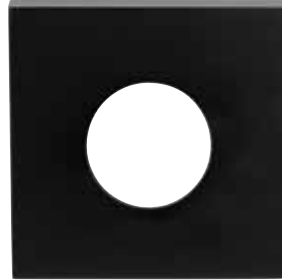

Square Rose Privacy Trim

Part Number VES2-TRIMMBK

* Pack of 2

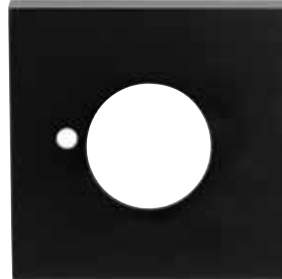

Velocity® Series Small Rose Door Furniture



The Velocity Small Series is a stylish range of door furniture suitable for both residential and semi-commercial applications. Designed primarily for new installation on timber doors, the range incorporates functionality for use with Mortice Locks in addition to Passage, Privacy and Dummy Levers.

Installation

Suits door thickness range of 32mm to 45mm.

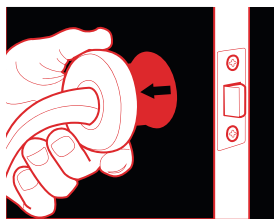

1 **Align** 2 **Twist** 3 **Tighten**



Features and Specifications

- All fixings are concealed beneath a removable rose trim providing an aesthetically appealing installation
- Simple twist and tighten fixing method with pre-assembled lever set allows for super easy and fast installation
- Choose from two lever designs, the ever popular Element L3 lever and the AS1428.1 compliant Dianella L8 lever
- Accessories include AS1428.1 compliant turn, standard turn and privacy indicating emergency turns
- The 55mm rose suits up to 45mm door thickness commonly used with mortice locks or latches
- Designed in Australia for the specific needs of the Australian market

Product Details

Rose Dimensions	55mm by 12.5mm - Round Rose 58mm by 12.5mm - Square Rose
Materials	Solid zinc die-cast lever with steel rose trims
Latches	Passage sets are available with a 60mm backset tubular latch. Privacy sets are supplied with a 60mm backset privacy latch which includes a locking pin for the inside of the door and an external emergency release function. The latch is automatically released when the internal handle is operated and is easily adapted for both open in and open out applications. All latches are supplied with industry standard "D" and "T" strikes.
Door Thickness	32mm to 45mm hinged doors
Finishes	Matt Black (MBK)

Standards and Compliance



Successfully tested up to 2 hours on fire door assemblies in accordance with the Australian Standard AS1905.1 2005 - Part 1: Fire Resistant Doorsets when used with Lockwood Synergy or Selector mortice locks

D8

Tested to AS4145.2 2008 for Durability passing D8 - 500,000 cycles



Tested to AS4145.2 2008 for Neutral Salt Spray, passing C6 - 168 hours



AS1428.1 Compliance. The range includes AS1428.1 compliant levers and turns

Velocity® Series Small Rose Door Furniture

Element™ - Lever 3

Length	122mm
Projection	54.5mm
Finger Clearance	47.5mm

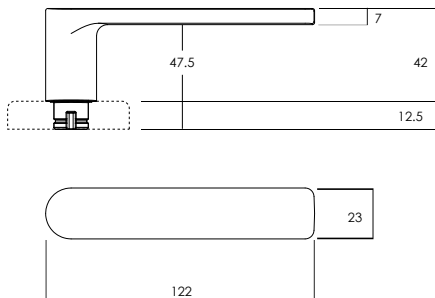

Mortice Lock Leverset

Part Number	VSR0/L3MBK
--------------------	------------

Passage Leverset

Part Number	VSR1/L3MBK
--------------------	------------

Dummy Lever

Part Number	VSR3/L3MBK
--------------------	------------



Privacy Leverset

Part Number	VSR2/L3MBK
--------------------	------------



Velocity® Series Small Rose Door Furniture

Dianella™ - Lever 8

Length 121mm

Projection 51mm

Finger Clearance 38mm



Disabled Accessible
AS1428.1

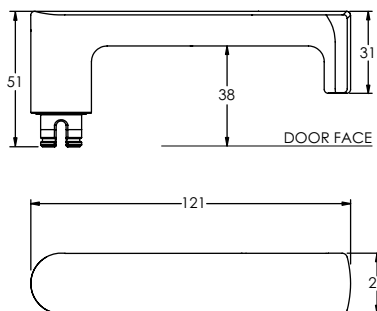

Mortice Lock Leverset

Part Number VSR0/L8MBK

Passage Leverset

Part Number VSR1/L8MBK



Privacy Leverset

Part Number VSR2/L8MBK



Velocity® Series Small Rose Door Furniture

Square Rose Passage Trim

Part Number VSS1-TRIMMBK

* Pack of 2

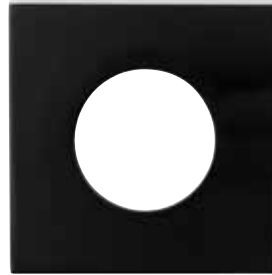

Square Rose Privacy Trim

Part Number VSS2-TRIMMBK

* Pack of 2

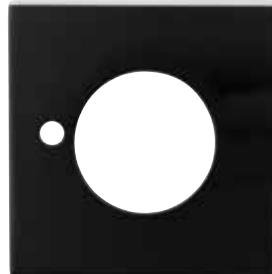

Velocity® Series Small Rose Door Furniture

Euro Cylinder Escutcheon

Part Number VSR5/MBK

Height 55mm

Depth 12.5mm

Supplied with
2x Wood Screws

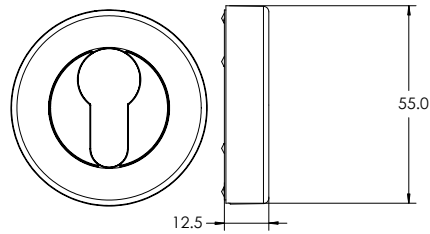

Oval Cylinder Escutcheon

Part Number VSR6/MBK

Height 55mm

Depth 12.5mm

Supplied with
2x Wood Screws

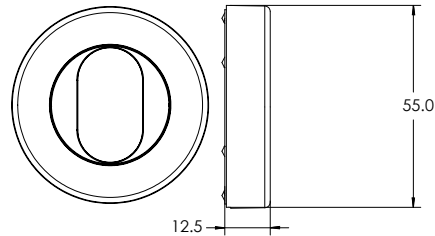

Standard Turnknob

Part Number VSR7/MBK

Height 55mm

Depth 12.5mm

Handing Not required

Supplied with
2x Wood Screws
1x Short Tail Bar
1x Medium Tail Bar
1x Tail Bar Spring
1x Instructions (1220-321)

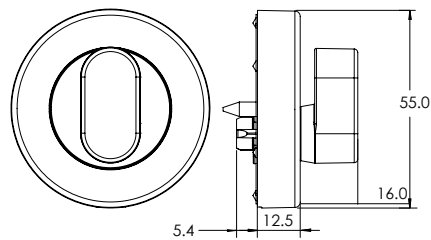

Privacy Indicating Emergency Turn

Part Number VSR8/MBK

Height 55mm

Depth 12.5mm

Supplied with
2x Wood Screws
1x Emergency Tail Bar
1x Instructions (1220-321)

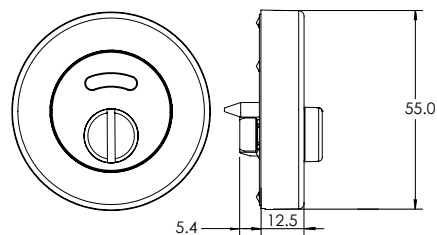

Velocity® Series Small Rose Door Furniture

Disabled Accessible Turnknob

Part Number VSR9/MBK

Height 55mm

Depth 12.5mm

Turn Snib Length 52mm

Handing Site handable

Supplied with

- 2x Wood Screws
- 1x Tail Bar (short)
- 1x Tail Bar (medium)
- 1x Tail Bar Spring
- 1x Instructions (1220-321)

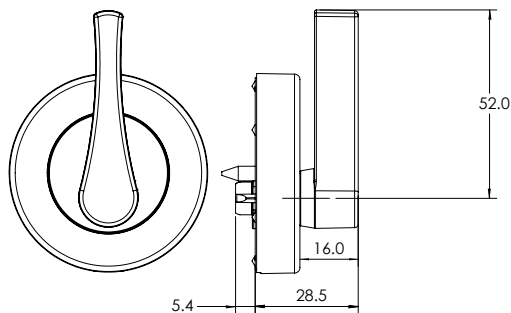

Square Rose Escutcheon Trim

Part Number VSS6-TRIMMBK

* Pack of 2

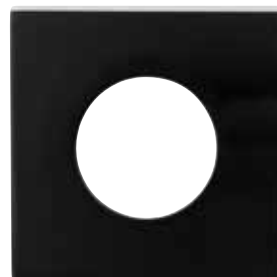

Cavity Sliding Door Lock



The Lockwood sliding door lock range is possibly the most innovative and aesthetically pleasing lock for a cavity sliding door in Australia. Combining elegance and ease of use, the Lockwood Cavity Sliding Door Lock range is ideal for any home décor and security solution.

Currently available with the privacy latch model, offering the perfect solution for residential bathroom sliding doors.

Features and Specifications

- Fitted flush against the panel of the sliding door for full recess into the door cavity

Retractable door pull

Designed after extensive research, the sliding cavity door lock features an innovative retractable door pull which combines style with functionality.

Product Details

Cross Drill	25mm
Door Thickness	32* to 40mm for timber doors *Requires spacer ring (included)
Finishes	Matt Black (MBK)
Latch Backset	60mm
Prep Hole	54mm
Strike	Box strike or pip strike (passage)
Materials	Furniture plate: Zinc Alloy Bolt: Nickel Plated Zinc (12.4mm projection) Bolt Beak: Stainless Steel Front End Plate: Stainless Steel Retractable Door Pull: Zinc Plated Strike Plate: Stainless Steel Strike Box: Zinc Plated

Cavity Sliding Door Lock

7400 Privacy Set

Part Number	Finish
7400MBKDP	Matt Black

Outside

Emergency release button opened by coin or screwdriver

Inside

Locked or unlocked by turn-plate

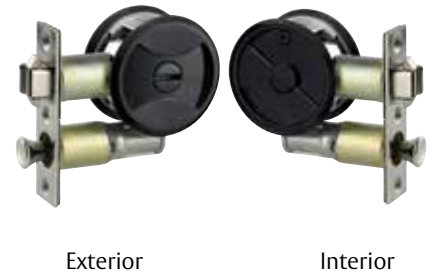
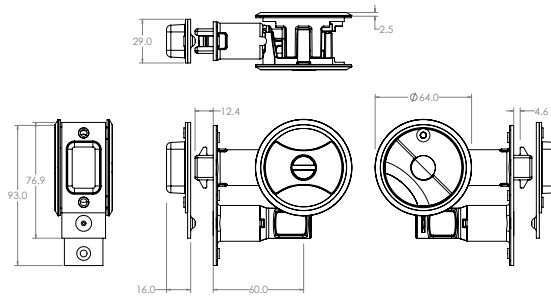

FP2 Flush Pull



The Lockwood Nero® Flush Pull offers multiple solutions for flush mount door furniture.

Application

Suited to numerous applications which require the door furniture to be flush with the surface of the door.

Product Details

Materials	Zinc Stainless Steel
------------------	-------------------------

Standards and Compliance

C6	These products have been successfully tested in accordance with AS 2331-3.1: 2001. Neutral Salt Spray Test (NSS TEST). Passing C6 Corrosion Resistance - 168 hours
-----------	--

FP2 Flush Pull

FP2-150

Dimensions	Packaging	Part Number
------------	-----------	-------------

150 x 50mm	Trade	FP2-150PC
------------	-------	-----------

Features and Specifications

- Stainless steel flush pull
- Trade packed, complete with fixing screws

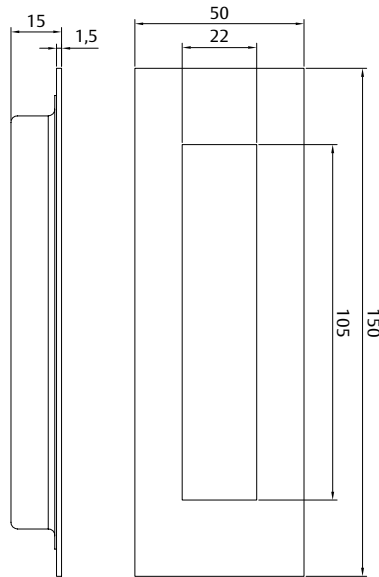

724 Series Slide Arm Door Closer



The Lockwood Rack & Pinion Slide Arm Series provides for a cleaner, more aesthetic appearance on the door whilst utilizing the same robust features and benefits of Rack and Pinion functionality.

Specifications

Power	EN adjustable 2 to 4
Back check (BC)	Adjustable
Hold Open	Adjustable. Hold-open can be set at any angle up to 150° of opening
Handing	Non-handed. Suitable for left or right hand doors
Cover	Clip-on
Materials	Extruded aluminium body manufactured from high-performance silicon alloy
Mechanism	Rack and pinion design
Mounting	Regular, parallel and over-door
Valves	Adjustable closing and latching speed valves with overload protection.

Standards and Compliance



Tested on fire door assemblies up to 4 hours in accordance with Australian Standard AS1905.1- 1997, Part 1: Fire Resistant Doorsets The Lockwood 724SR series closer has been successfully tested upto four hours (depending on type of doorset) on fire door assemblies in accordance with Australian Standard AS1905.1:2005, Part: Fire Resistant Door sets.

Note: Hold open option is not approved on any fire door.

724 Series Slide Arm Door Closer

724SR Slide Arm Pull Side

Part Numbers

724SRBLK

Closer installed on pull side of door. This mounting position permits opening of 130°.

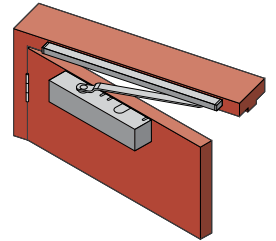
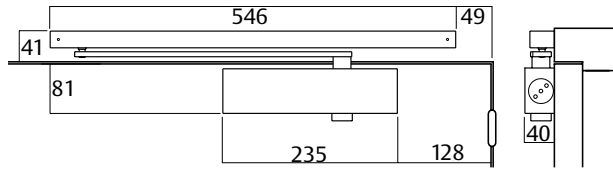

724SR Slide Arm Push Side

Part Numbers

724SRBLK

Closer installed on push side of door. This mounting position permits opening of 115°.

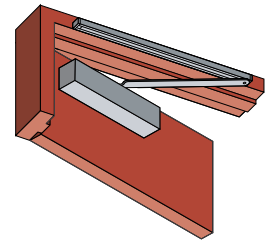
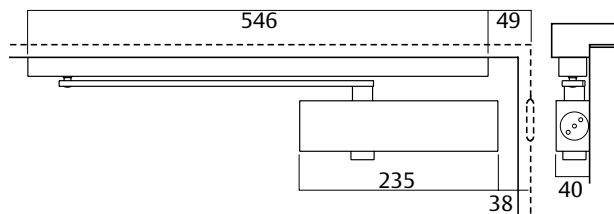

724SR Slide Arm Over Door Mounting Push Side

Part Numbers

724SRBLK

Closer installed on push side of door and top rail where conditions do not allow parallel mounting. This mounting position permits opening of 115°.

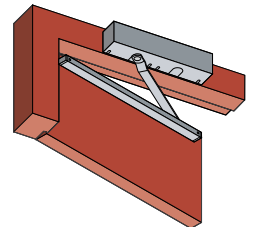
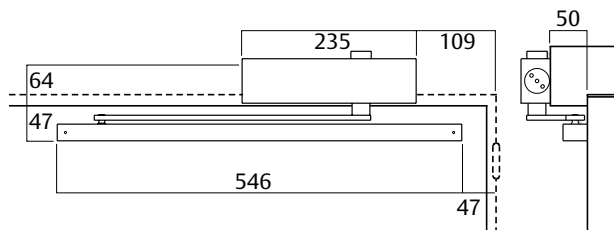

Nexion® Mechanical Entrance Lockset



The Nexion Entrance Lockset represents the next generation in home security.

Designed and manufactured to the highest standards of quality, the Lockwood Nexion has set the benchmark for safety, security and style. The Nexion offers the ultimate protection for your home and family.

Features and Specifications

- Three mode security: Secure, Safety and Passage mode provides excellent security without compromising convenience
- LockAlert® indicator shows lock status at a glance
- SafetyRelease™ automatically unlocks the inside handle upon entry to minimise the risk of being locked in
- High security latch
- Box strike with concealed crossgrain door frame strengthening screw
- Can be keyed alike to other Lockwood door locks as well as builder's key systems

Product Details

Backset	60mm as supplied 70mm optional (order part 530-222SC)
Case	High purity zinc alloy
Door Thickness	35 to 45mm
Finishes	Matt Black (MBK)
Handles	Element Lever 3
Latch	13mm projection brass bolt
Strike	Box strike with concealed crossgrain door frame strengthening screw
Templates	Installation template included
Handing	Adjustable handing by set screw
Cylinder	Internal and external 5 pin tumbler mechanism with 6 pin capability Brass cylinders and brass barrels

Standards and Compliance



The locksets can be optioned to suit fire door sets with a fire resistance level of up to 1 hour on fire door assemblies in accordance with Australian Standard AS1905.1:2005 Fire Resistant Doorsets. The fire rated option is achieved with a standard Nexion Vision Entrance Lockset and the optional fire rated kit (order NXVFRKIT).

SL7

(Security) Australian Lock Standard (AS4145.2.2008)

D8

(Durability) Australian Lock Standard (AS4145.2.2008)

C5

(Corrosion) Australian Lock Standard (AS4145.2.2008)

CE

CE Approved



C-tick certified

Nexion® Mechanical Entrance Lockset

Keying

- Supplied individually keyed with two keys per lock
- 78,000 key combinations
- Key blank KB2015P

Restricted Special Keying

Lockwood locks can be keyed to a number of controlled and/or specially keyed systems. These range from legally protected keys to protect against unauthorised duplication, which can also include specially designed key systems such as master key systems, which allow for different levels of mechanical access control.

Please refer to Lockwood Keying Catalogue or contact your local sales office or customer service for specific information.

Latch Dimensions

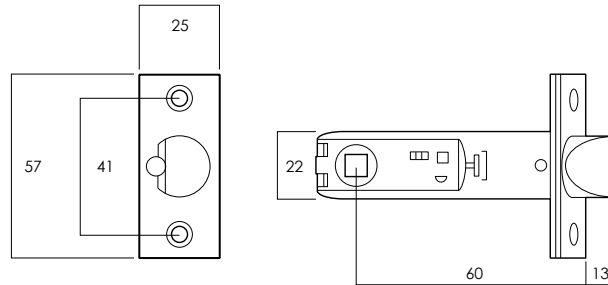

Kinetic Defence®
Bump and pick resistant.



Deadlatch Bolt
13mm projection
brass bolt.



SafetyRelease™
Minimises the risk of being
locked in.



2 Keys Included
Can be keyed alike to other
Lockwood door locks.



LockAlert®
Interior Indicator shows lock
status at a glance.



Quick Installation
Suitable for door thicknesses
between 35–45mm.



Safety Mode
Securely locked from outside
and free from inside.



Retrofittable
Fits majority of doors with
54mm hole.



Secure Mode
Securely locked from both
inside and outside. For when
nobody is home.



Passage Mode
Free to enter from outside
and free to exit from inside.

Nexion® Mechanical Entrance Lockset

Nexion Vision - Double Cylinder



Exterior



Interior

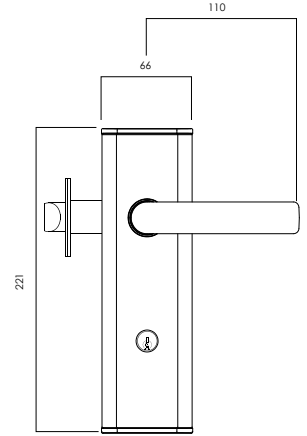
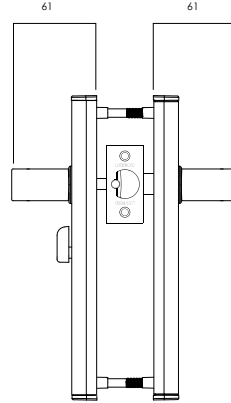
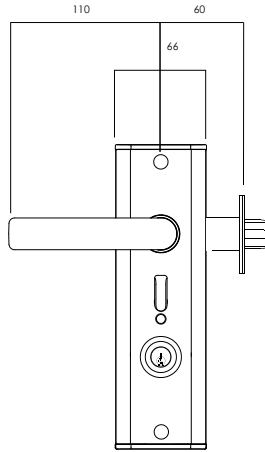

Nexion® Mechanical Entrance Lockset

Ordering Procedure

Series	Function	Cylinders	App. Options	Levers	Finish	Keying
NXV	1	2	1	L3	MBK	-

Series	Cylinders	Levers	Keying
Nexion Vision NXV	Double 2	Element L3	Keyed to Differ (Standard) -

Function	Application Options	Finish	Keying
Mechanical 1	Timber Frame Strike* 1	Matt Black MBK	Keyed Alike 5 Pins 5KA
			Project Keyed 5 Pins 5PK
			Restricted Profile 5 Pins 5RP
			Keyed Alike 6 Pins 6KA
			Project Keyed 6 Pins 6PK

**Metal Frame T-Strike optional (order part NX8/40SC)*

**For Fire Rated Nexion Vision option (order part NXVFRKIT)*

Paradigm® 005 Cylinder Deadbolt



The Paradigm® 005 Double Cylinder Deadbolt is the premium security solution with its innovative safety features. The contemporary styling can be combined with any lever or entrance handle to create an elegant security solution, ideal for residential and architectural applications.

Key Features

- Three function modes with DualSelect® provides combination of convenience and security
- High security cut resistant stainless steel bolt
- Safety Release™ automatically unlocks internal knob upon key entry from outside
- LockAlert® indicator shows lock status at a glance
- Available in round or square rose

Restricted Special Keying

Lockwood locks can be keyed to a number of controlled and/or specially keyed systems. These range from legally protected keys to protect against unauthorised duplication, which can also include specially designed key systems such as master key systems, which allow for different levels of mechanical access control.

Please refer to Lockwood Keying Catalogue or contact your local sales office or customer service for specific information.

Retrofittable

Replace your existing Deadbolt. Fits 54mm hole. 60-70mm adjustable backset. 32-48mm door thickness.

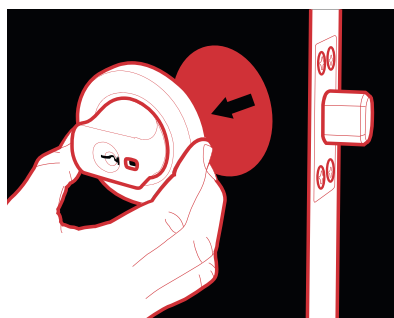

Product Details

Backset	60 to 70mm adjustable stainless steel bolt
Bolt	High security, cut resistant stainless steel bolt
Cylinder	5 pin tumbler mechanism Brass cylinder and brass barrel
Door Thickness	32–48mm 32–36mm doors require a spacer (Included)
Finishes	Matt Black (MBK)
Keying	Supplied individually keyed with two keys per lock, 78,000 key combinations, Key blank KB2015P
Materials	High purity zinc alloy
Strike	Box strike with concealed crossgrain door frame strengthening screw

Standards and Compliance

SL8	(Security) Australian Lock Standard (AS4145.2 - 2008)
D8	(Durability) Australian Lock Standard (AS4145.2 - 2008)
C6	(Corrosion) Australian Lock Standard AS4145.2 - 2008)
K5	(Key Security) Australian Lock Standard AS4145.2 - 2008)

Paradigm® 005 Cylinder Deadbolt

Round Rose



Exterior



Interior

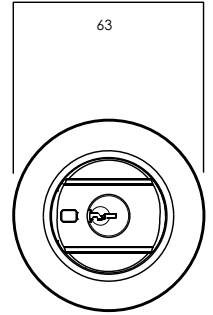
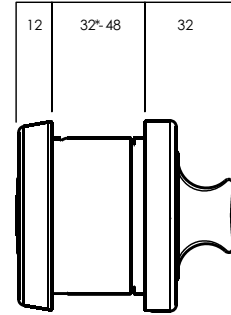
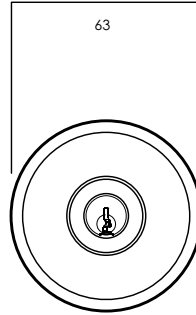

*32–36mm door thickness requires spacer ring (included)



Kinetic Defence®
Bump and pick resistant.



Counterbalance Bolt
Proportionally distributes the load between the door and door frame.



DualSelect®
Turn the key for safety mode. Turn the key further to select secure mode.



2 Keys Included
Can be keyed alike to other Lockwood door locks.



SafetyRelease™
Minimises the risk of being locked in.



Retrofitable
Replace your existing Deadbolt. Fits 54mm hole. 60-70mm adjustable backset. 32-48mm door thickness.



Anti-Corrosion
Successfully tested in accordance with AS2332.3.1:2001 neutral salt spray test.



LockAlert®
Interior Indicator shows lock status at a glance.



Safety Mode
Securely locked from outside and free from inside.



Secure Mode
Securely locked from both inside and outside. For when nobody is home.



Passage Mode
Free to enter from outside and free to exit from inside.

Paradigm® 005 Cylinder Deadbolt

Square Rose



Exterior



Interior

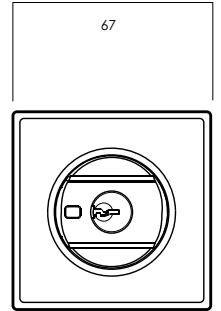
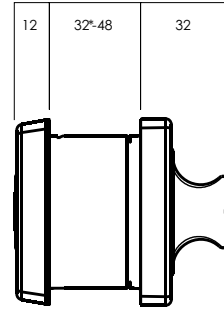
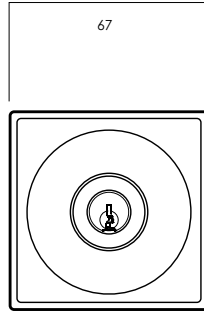

*32–36mm door thickness requires spacer ring (included)



Kinetic Defence®
Bump and pick resistant.



Counterbalance Bolt
Proportionally distributes the load between the door and door frame.



DualSelect®
Turn the key for safety mode. Turn the key further to select secure mode.



2 Keys Included
Can be keyed alike to other Lockwood door locks.



SafetyRelease™
Minimises the risk of being locked in.



Retrofitable
Replace your existing Deadbolt. Fits 54mm hole. 60-70mm adjustable backset. 32-48mm door thickness.



Anti-Corrosion
Successfully tested in accordance with AS2332.3.1:2001 neutral salt spray test.



LockAlert®
Interior Indicator shows lock status at a glance.



Safety Mode
Securely locked from outside and free from inside.



Secure Mode
Securely locked from both inside and outside. For when nobody is home.



Passage Mode
Free to enter from outside and free to exit from inside.

Paradigm® 005 Cylinder Deadbolt

Ordering Procedure

Series	Type	Rose Style	Finish	Packaging	Keying
005	B	1	MBK	DP	
Series	Rose Style	Packaging			
Paradigm® Deadbolt 005	Round 1 Square 2	Universal Pack DP Trade Pack			
Type	Finish	Keying Options			
Bolt B	Matt Black MBK	Special Keying-Residential Keyed Alike 5P 5KA Keyed Alike 6P 6KA Project Keyed 5P 5PK Project Keyed 6P 6PK Restricted Profile 5P 5RP			

* For keying options please contact customer service.



ASSA ABLOY

Lockwood is the leading brand in the Australian locking industry. With an established reputation for high quality products, this iconic brand provides a wide range of locking solutions to residential housing, commercial, semi-commercial, building and industrial application markets. Lockwood is supported by an extensive distribution and after-sales support network. Our customers include retailers, architects, trade and industrial personnel, locksmiths and security dealers.

ASSA ABLOY is the global leader in door opening solutions, dedicated to satisfying end-user needs for security, safety and convenience.

ASSA ABLOY is represented in all major regions, in both mature and emerging markets, with leading positions in Australia, Europe and North America.

**25YEAR
MECHANICAL
WARRANTY**

The Lockwood 25 Year Mechanical Warranty

Our belief that we manufacture the finest premium products available in today's market place is backed by the Lockwood 25 Year Mechanical Warranty, ensuring that Lockwood continues to keep Australians safe by delivering security and peace of mind.

For warranty terms and conditions, please visit www.lockweb.com.au or call **1300WARRANTY**

ASSA ABLOY Australia Pty Ltd
235 Huntingdale Road
Oakleigh, Victoria, 3166
Australia

1300 LOCK UP (1300 562 587)
lockweb.com.au

ASSA ABLOY New Zealand Ltd
6 Armstrong Road
Albany, Auckland, 0632
New Zealand

info.nz@assaabloy.com
Telephone +64 9415 7111
assaabloy.co.nz



30 Byass Street
Shepparton
03 5821 7277

Disclaimer

Whilst every effort has been made to ensure that the information (including product images and drawings) contained in this brochure is accurate at the time of publication, ASSA ABLOY Australia Pty Limited ("ASSA ABLOY") recommends that you consult ASSA ABLOY or its agents prior to placing an order to ascertain current information on specific products, as ASSA ABLOY reserves the right to make changes without notice. ASSA ABLOY will not be liable for any injury, loss or damage whatsoever, arising from any errors or omissions in the information contained in the brochure or arising from the use or application of the information contained herein. © 2018 copyright by ASSA ABLOY All rights reserved

