

KEYSTONE INDUSTRIES™

PIER CAPPING SELECTION



Pier Capping Victorian

PC-VIC

Standard sizes:
1.5 x 1.5 | 2 x 2 | 2.5 x 2.5 Brick size pier.
Custom size available on request.

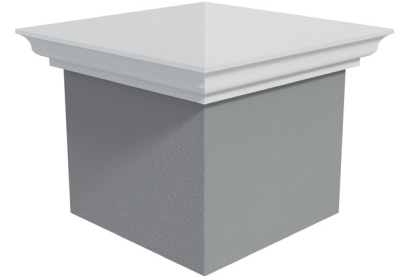
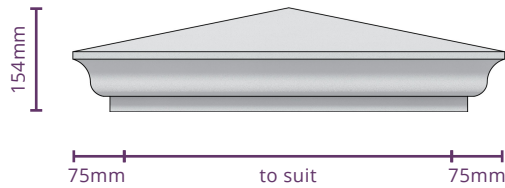

Pier Capping Edwardian

PC-EDW

Standard sizes:
1.5 x 1.5 | 2 x 2 | 2.5 x 2.5 Brick size pier.
Custom size available on request.

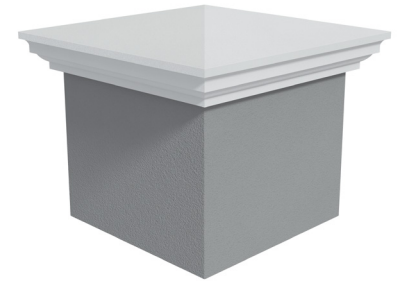
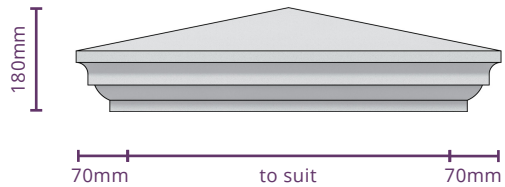

Pier Capping Georgian

PC-GOR

Standard sizes:
1.5 x 1.5 | 2 x 2 | 2.5 x 2.5 Brick size pier.
Custom size available on request.

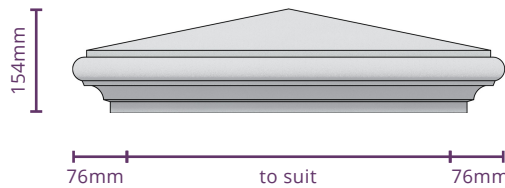

Pier Capping Plain

PC-PLN

Standard sizes:
1.5 x 1.5 | 2 x 2 | 2.5 x 2.5 Brick size pier.
Custom size available on request.

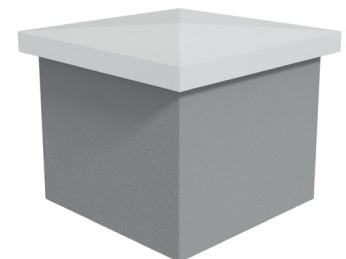
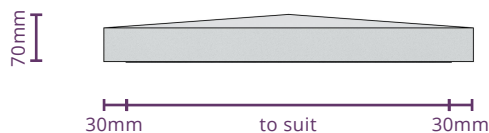

Pier Capping French

PC-FRE_T

Standard sizes:
2 x 2 | 2.5 x 2.5 Brick size pier.
Custom size available on request.

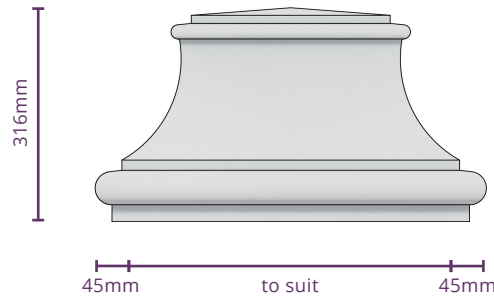

Pier Capping French Small

PC-FRE_S

Standard sizes:
2 x 2 | 2.5 x 2.5 Brick size pier.
Custom size available on request.

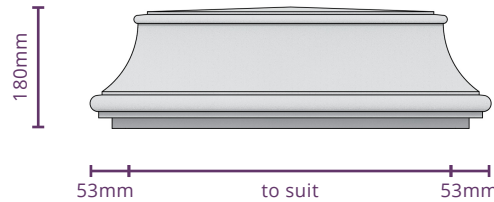

Pier Capping FM250

PC-FM250

Standard sizes:
2 x 2 | 2.5 x 2.5 Brick size pier.
Custom size available on request.

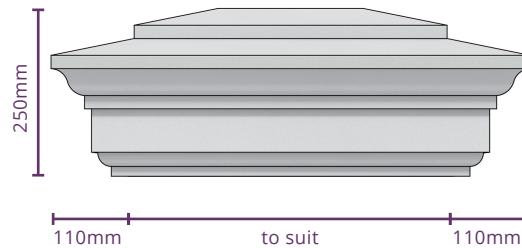

Pier Capping FM180

PC-FM180

Standard sizes:
2 x 2 | 2.5 x 2.5 Brick size pier.
Custom size available on request.

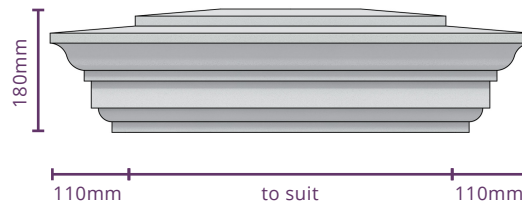

ADDRESS

Victoria

Unit 5B, 1764 Sydney Road
Campbellfield VIC 3061

75 Rodeo Drive
Dandenong South VIC 3175

New South Wales

8 Forsyth Close
Wetherill Park NSW 2164

South Australia

24 Humphries Terrace
Kilkenny SA 5009

CONTACT

sales@rendex.com.au

National **1300 663 118**
Campbellfield **03 9357 7316**
Dandenong **03 8738 8110**
Wetherill Park **02 9725 1915**
Kilkenny **08 8244 1999**

OUR BRANDS

Rendex® Mouldex®
KEYSTONE INDUSTRIES™

Available from: